



WPS 310



User Manual/ Manual de uso

Ver. 15.12.03

WPS 310 PENDANT SPEAKER

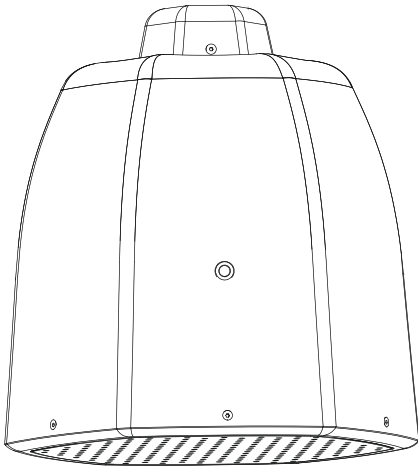

SPECIFICATIONS

- Coaxial Transducer: LF: 1x10";
HF: 1x1" compression driver
- Freq. range: 96 - 15k5 Hz (± 3 dB)
70 - 19kHz (-10dB)
- Sensitivity (1W/1m): 95 dB SPL
- Nominal Impedance: 8 Ω
- Power handling (8 Ω): 250W AES*
1000W peak
- Max. SPL (dB@1m): 119 dB//125 dB
- Recommended power amplif.: 500W @8 Ω
- 100V transformer: 50W
- Connections:
100V line: Yellow(+), Blue(-), Brown & Red linked
8 Ω : Blue (-), Red (+), Brown & Yellow terminals
NOT connected between them.
- Nominal Bandwidth 500-4k Hz): 90° \pm 10°@6dB
- Material: Black fiber
- Finish: Rough black matte painting
- Dimensions: \varnothing 386 x 413 mm
- Weight: 9.2 kg

Built-in Plate with special design for steel pendant cable.

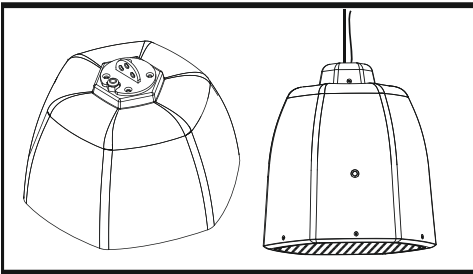

PBU 31 Handle Perfect option to make directional the sound of your **WPS 310**. (NOT INCLUDED)

(*) AES 1984 REV. 2003

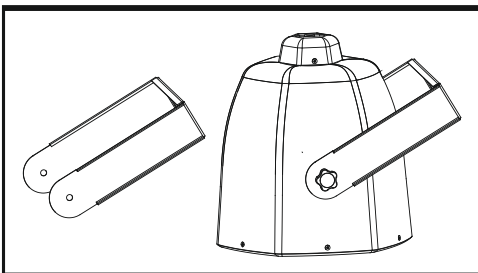

WPS 310 PENDANT SPEAKER

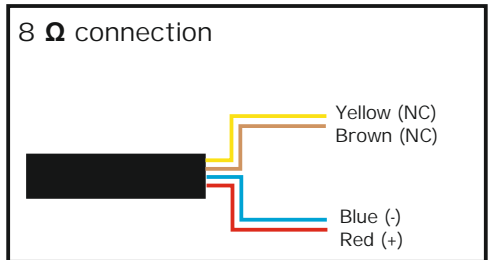
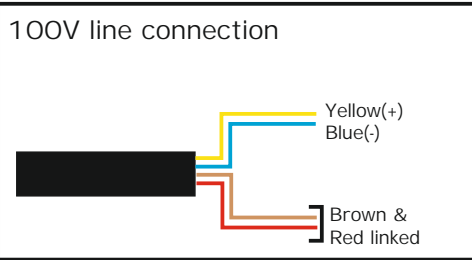
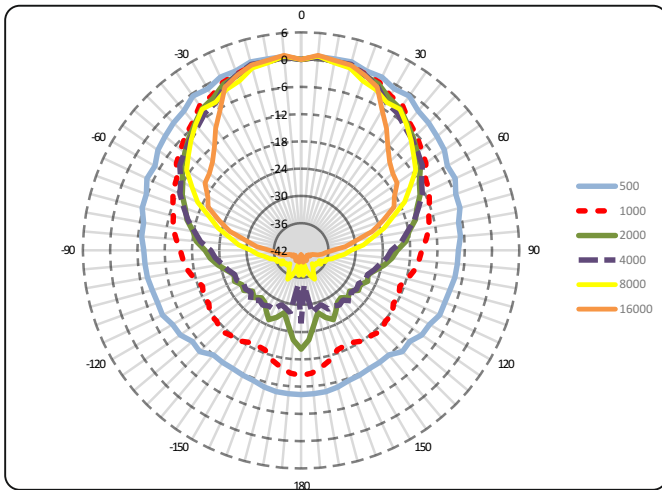
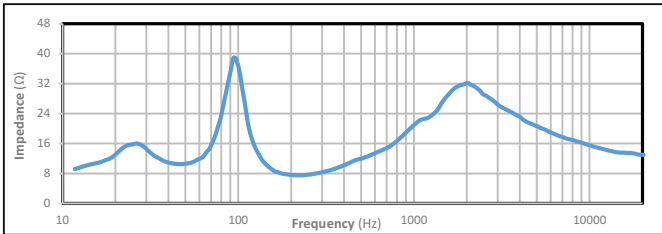
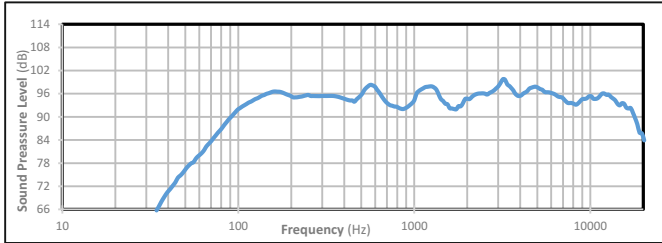

WPS 310

ALTAVOZ DE SUSPENSION

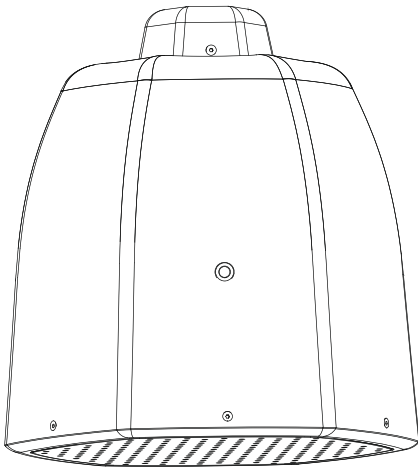

ESPECIFICACIONES

- Transductor Coaxial: LF: 1x10";
HF: 1x1" driver de compresión
- Rango de frec.: 96 - 15k5 Hz (± 3 dB)
70 - 19kHz (-10dB)
- Sensibilidad (1W/1m): 95 dB SPL
- Impedancia Nominal: 8 Ω
- Potencia manejada (8 Ω): 250W AES*
1000W peak
- Max. SPL (dB@1m): 119 dB//125 dB
- amplif. de potencia recomend.: 500W @8 Ω
- Transformador 100V: 50W

Pletina incorporada: con un diseño especial para utilizar un cable de acero

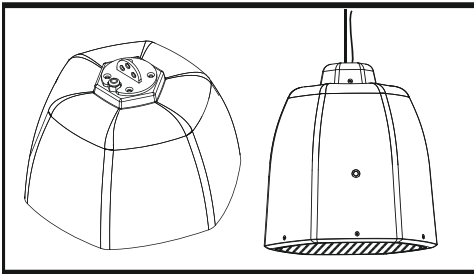

- Conexiones:
100V line: Amarillo (+), Azul (-), Rojo/marrón unidos
8 Ω : Azul (-), Rojo (+), Terminales Amarillo y Marrón,
NO conectados entre ellos

- Ancho de banda 500-4k Hz): $90^{\circ} \pm 10^{\circ} @ 6$ dB
- Material: Fibra
- Acabado: Pintura negra mate
- Dimensiones: \varnothing 386 x 413 mm
- Peso: 9.2 kg

Asa PBU 31: Opción perfecta para direccionar el sonido de su WSP 310 (OPCIONAL)

(*) AES 1984 REV. 2003

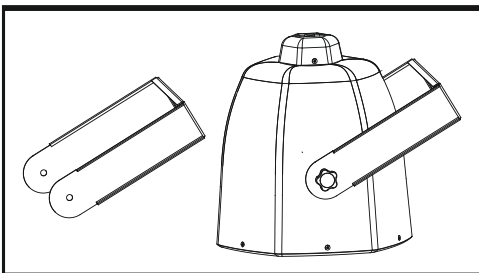

WPS 310 ALTAVOZ DE SUSPENSION

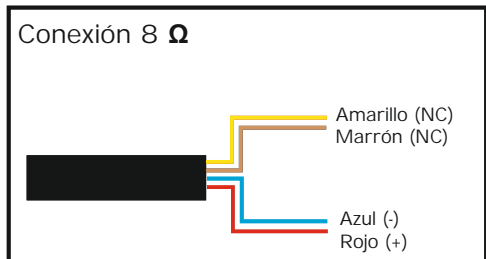
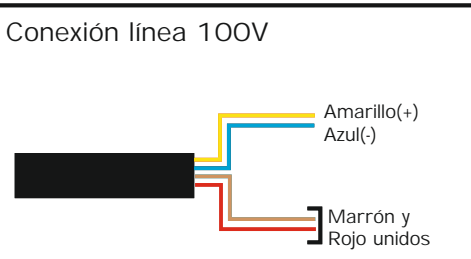
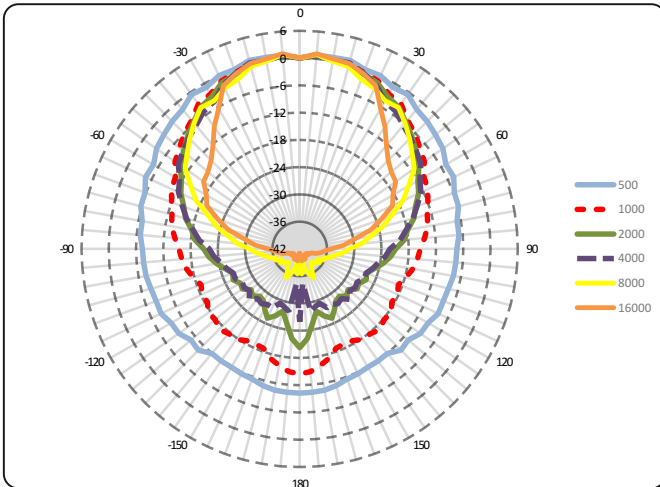
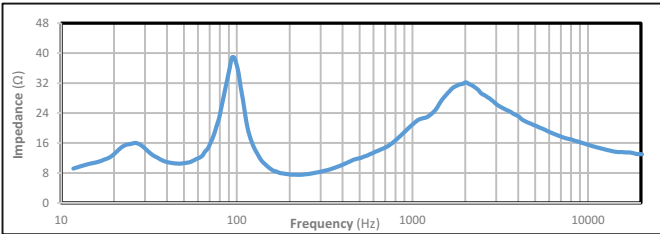
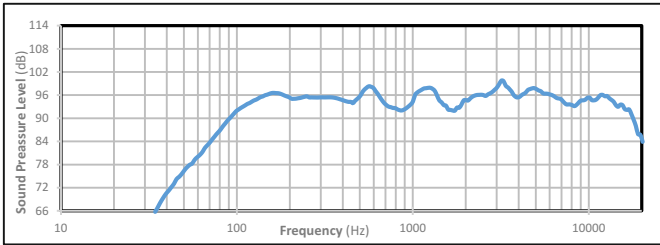



EQUIPSON, S.A.

Avda. El Saler, 14 - Pol. Ind. L'Alteró, 46460 - Silla (Valencia) Spain

Tel. +34 96 121 63 01 Fax + 34 96 120 02 42

www.workproaudio.com support@work.es