

MIPRO®

User Guide

Headworn Microphone Series

MIPRO®
MICROPHONE PROFESSIONALS

MIPRO Electronics Co., Ltd

Headquarters : 814 Pei-Kang Road, Chiayi,60096,Taiwan
Tel : +886.5.238.0809 Fax : +886.5.238.0803
www.mipro.com.tw mipro@mipro.com.tw

All rights reserved. MN 014/05
Do not copy or forward without prior approvals MIPRO.
Specifications and design subject to change without notice.

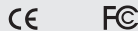

2 CE356E



Part Names And Functions

MU-13d

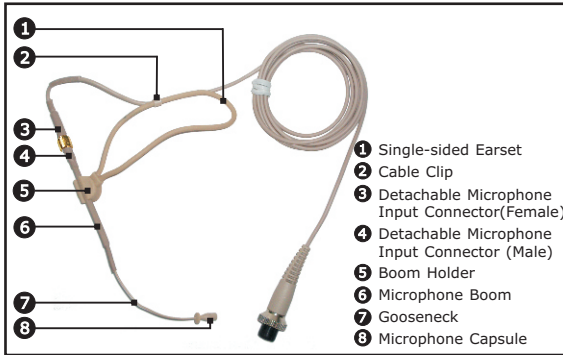

Parts

- MU-1FL: Large single-sided earset
- MU-1FM: Medium single-sided earset
- MU-1FS: Small single-sided earset
- Foam Windscreen
- MU-3M: Ultra-mini microphone capsule module
- Carrying Case
- User Guide

Assembly Illustrations of MU-13d

Plug male MMCX ④ connector into female MMCX ③ socket and fasten firmly.

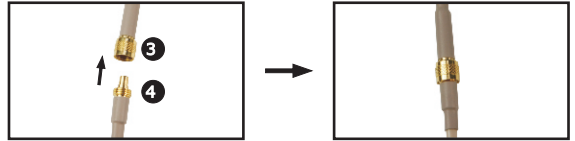

Select a suitable size (S, M or L) single-sided earset ① . Attach the microphone boom into the microphone boom holder.

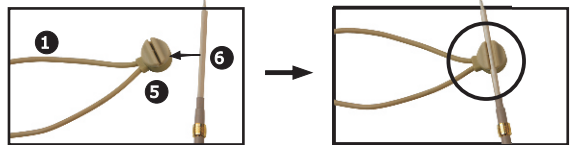

Clip the cable ① and earset ② together firmly in place.

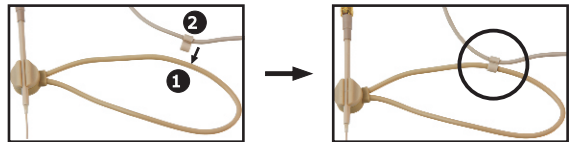

Caution

If noise or signal drop-out occurs, double check if the connection of MMCX is loose. Fasten firmly in place, if it is. A loose MMCX connection may produce noises and unstable signal transmission.

Widen and adjust the earset proportional to fit user's ear.

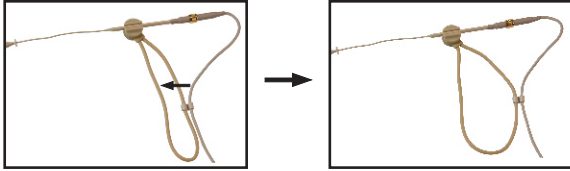

Bent inward to form an appropriate curvature.

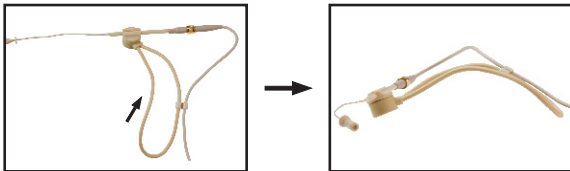

Wearing MU-13d Earset Microphone

Place the earset over your ear. Press against your earlobe and reshaped for a comfortable and snug feel. (Move your head up & down and sideways few times to ensure it is not loosely fitted)

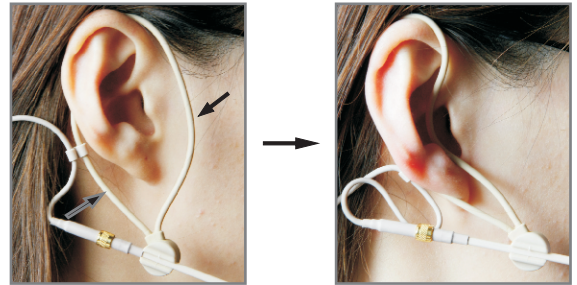

Adjustment of MU-13d

For ideal location, position the microphone boom **7** so the microphone is about 1cm of the corner of your mouth.

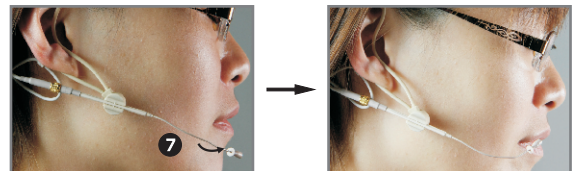

Part Names And Functions MU-23d

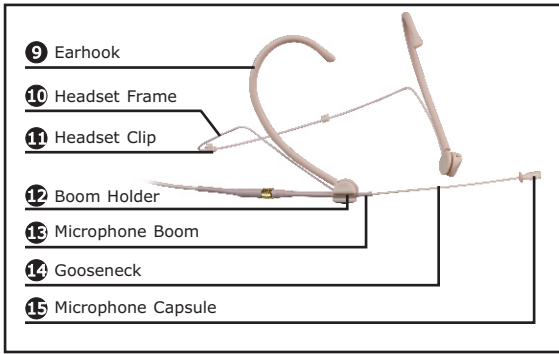

Parts

- MU-2FL: Large dual-sided headworn frame
- MU-1FM: Medium single-sided earset
- MU-1FS: Small single-sided earset
- Foam Windscreen
- MU-3M: Ultra-mini microphone capsule module
- Carrying Case
- User Guide

Part Names And Functions MU-210d

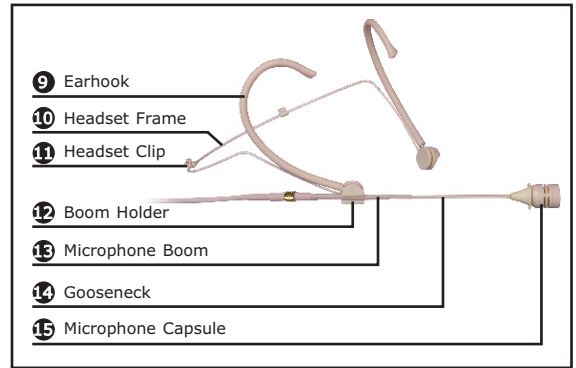

Parts

- MU-2FL: Large dual-sided headset frame
- MU-2FM: Medium dual-sided headset frame
- MU-2FS: Small dual-sided headset frame
- Foam Windscreen
- MU-10M: Uni-directional condenser capsule module
- Carrying Case
- User Guide

Illustration of MU-23d/MU-210d Assemble

Select a suitable headset frame size. Attach the microphone boom **13** into the microphone boom holder **12**. Insert the cable by clipping into the headset frame **11** (see diagram 1)

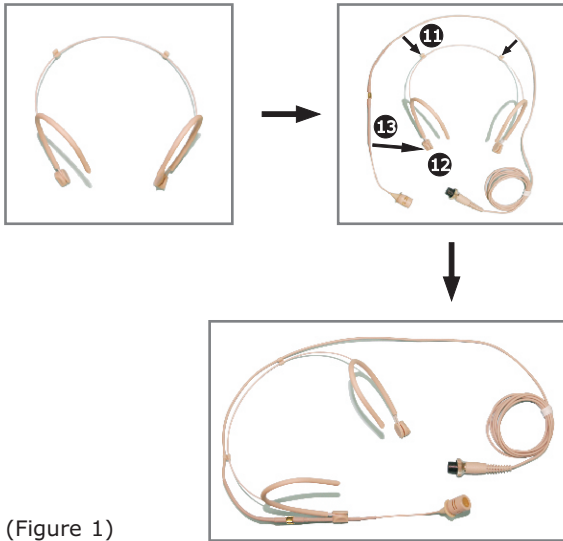

(Figure 1)

Adjustment of MU-23d

For ideal location, position the gooseneck **14** so the microphone is about 1cm of the corner of your mouth.

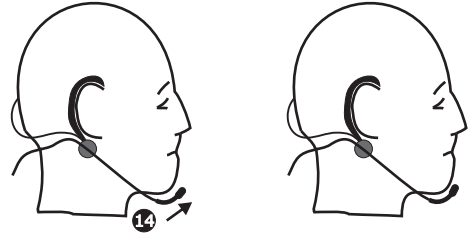

Illustrations

(2-Wire)

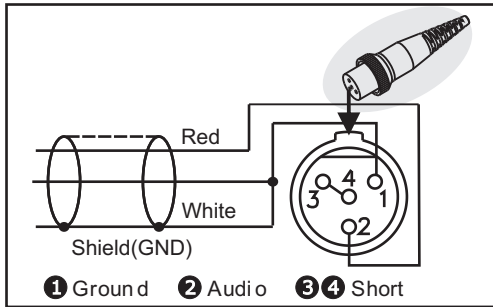

(3-Wire)

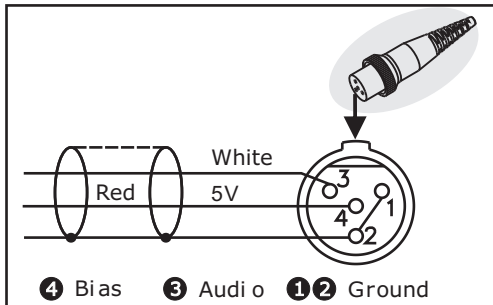

How to Obtain Ideal Sound Quality When Wearing Headworn Microphone?

1. Position the microphone and boom so that the microphone is about 1.0~1.5cm (0.4~0.6-inch) of the right or left corner of your mouth to minimize breath or "popping" noise.
2. Omni-directional (Figure 2) and Uni-directional (Figure 3) types are available. Ideal way to wear "Omni" type is to have microphone capsule closer to the corner of the mouth with about 1.0~1.5cm (0.4~0.6-inch) away (see Figure 4 and 5) to minimize breath or "popping" noise for ideal sound quality. (See Figure 6).
3. "Uni" type is directional. During live performance, it has stronger bass sound and higher dynamic range, better suited for "music" effect. However ideal wearing position for Uni is more complicated than Omni. Apart from the sensitivity level changes due to distances away from mouth, it is more susceptible to the Proximity effect and popping noise. In theory, it is recommended to position uni-directional capsule in front of mouth for ideal sound quality. However this position is vulnerable to the problems of popping noise, and affects both types of capsules. In reality, the ideal wearing position for sound quality refers to (Figure 7) (about 45 degree angle and 1.0~1.5cm distance away from the edge of mouth).
4. Amplified system is recommended during sound check for adjusting the ideal microphone position.

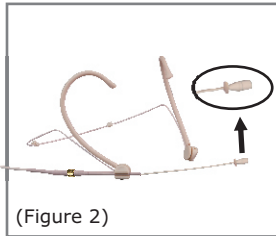

(Figure 2)

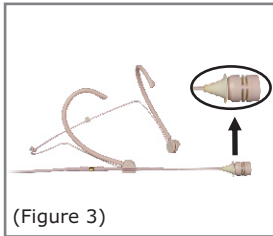

(Figure 3)



(Figure 4)



(Figure 5)

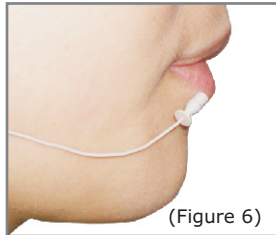

(Figure 6)

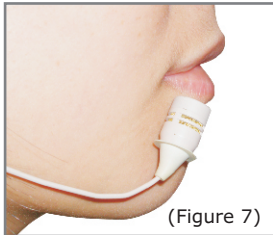

(Figure 7)

Transmitter Controls & Indicators

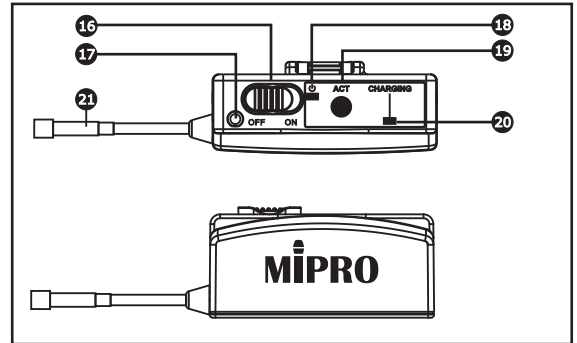

16 Power On/Off Switch

17 **Charging Socket:** Use supplied charger only.

18 Power Indicator:

- **Fresh Battery** - The Power Indicator will illuminate for 1 second and extinguish after power is turned on.
- **Low Battery** - The Power Indicator will flash continuously indicating the battery level is low and needs to be recharged within 10 minutes.

- 19 **ACT (IR) Port:** Align both receiver and transmitter ACT ports within 30cm of each other when the ACT button on the receiver is pressed for a successful ACT synchronization.
- **Successful ACT syncing:** The Power Indicator will illuminate for 1 second and extinguish after channels are synchronized successfully.
 - **Unsuccessful ACT syncing:** The Power Indicator will flash continuously for 5-6 seconds. Check to see if different transmitter and receiver frequency bands are used.
- 20 **Charging Indicator:** Red indicator denotes charging; Green indicator denoted charged. Fully charge may take up to 3-4 hours.
- 21 **Connecting Cable and Connector**

How to Install the Headworn Transmitter and Microphone

1. Unfasten the latch lock by turning it sideways. Open the latch upward.

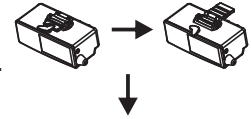

2. Place the headset frame (middle section) into the groove of Miniature Transmitter firmly (see picture). Ensure the two round-shape microphone boom holders are in the same direction as the latch lock.

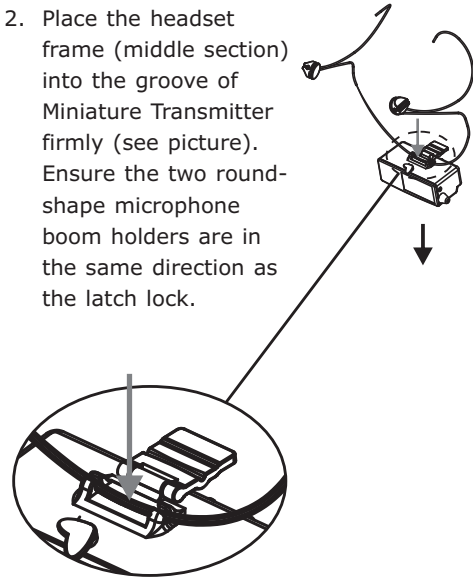

3. Close the latch.

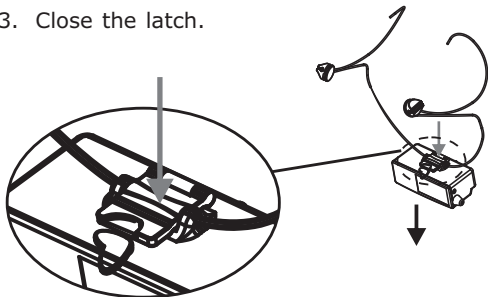

4. Fasten the hatch by turning the hatch lock firmly in place.

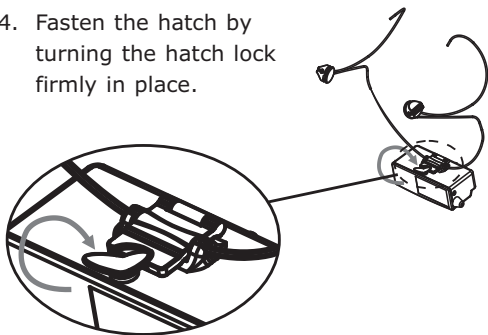

Charging Method

- Power off transmitter.
- Plug the supplied charger into the AC mains input socket and then plug it into Miniature Transmitter.
- Do not use charger from other brands to avoid insufficient voltage or current.
- Do not exceed the input supply voltage as it may damage the battery charger, rechargeable battery and transmitter itself. The output of MIPRO DC power supply is 12V/0.2A.

Viewing Charging Status

- Charging: Red LED indicator.
- Charged: Green LED indicator.

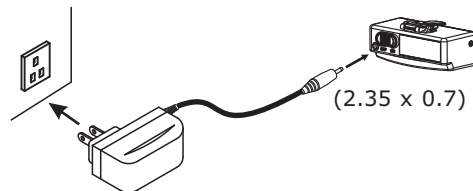

Note

Rechargeable batteries have a limited number of charge cycles and may eventually need to be replaced. Battery life and number of charge cycles vary by usage and user settings.

WARNING

1. **FOR OUTDOOR USE:**

To reduce the risk of fire or electric shock, do not expose this apparatus to rain or moisture.

2. **UNDER WET LOCATION:**

Apparatus should not be exposed to dripping or splashing and no objects filled with liquids, such as vases should be placed on the apparatus.

3. **SERVICE INSTRUCTIONS:**

CAUTION - These servicing instructions are for use by qualified service personnel only. To reduce the risk of electric shock, do not perform any servicing other than that contained in the operating instructions unless you are qualified to do so.



This symbol indicates that dangerous voltage constituting a risk of electric shock is present within this unit.



This symbol indicates that there are important operating and maintenance instructions in the literature accompanying this unit.

FCC

THIS DEVICE COMPLIES WITH PART 74 OF THE FCC RULES.

OPERATION IS SUBJECT TO THE FOLLOWING TWO CONDITIONS:

- (1) This device may not cause interference.
- (2) This device must accept any interference, including interference that may cause undesired operation of the device.

This equipment complies with FCC RF radiation exposure limits set forth for an uncontrolled environment.

IC

This device complies with Industry Canada RSS-123 ISSUE 2 standards. Operation is subject to the following two conditions:

- (1) this device may not cause interference, and
- (2) this device must accept any interference, including interference that may cause undesired operation of the device.

Le présent appareil est conforme aux CNR d'Industrie Canada applicables aux appareils radio exempts de licence. L'exploitation est autorisée aux deux conditions suivantes: (1) l'appareil ne doit pas produire de brouillage, et (2) l'utilisateur de l'appareil doit accepter tout brouillage radioélectrique subi, même si le brouillage est susceptible d'en compromettre le fonctionnement.

Disposal Dispose of any unusable devices or batteries responsibly and in accordance with any applicable regulations.



2005-08-13

Disposing of used batteries with domestic waste is to be avoided!

Batteries / NiCad cells often contain heavy metals such as cadmium(Cd), mercury(Hg) and lead(Pb) that makes them unsuitable for disposal with domestic waste. You may return spent batteries/ accumulators free of charge to recycling centres or anywhere else batteries/accumulators are sold.

By doing so, you contribute to the conservation of our environment!

Notes

1. Refer to actual product in the event of product description discrepancy.
2. Frequency range and maximum deviation comply with the regulations of different countries.