

### MI-909R Digital Stereo Bodypack Receiver



## **! IMPORTANT SAFETY INSTRUCTIONS !**

1. Read these instructions.
2. Keep these instructions.
3. Heed all warnings.
4. Follow all instructions.
5. Do not use this apparatus near water.
6. Clean only with a dry cloth.
7. Do not block any ventilation openings. Install in accordance with the manufacturer's instructions.
8. Do not install near any heat sources such as radiators, heat registers, stoves, or other apparatus (including amplifiers) that produce heat.
9. Do not defeat the safety purpose of the polarised or ground plug: A polarised plug has two blades with one wider than the other. The wide blade is provided for your safety. When the provided plug does not fit into your outlet, consult an electrician for replacement of the obsolete outlet.
10. Protect the power cord from being walked on or pinched particularly at plug, convenience receptacles, and the point where they exit from the apparatus.
11. Only use attachments/accessories specified by the manufacturer.
12. Use only with a cart, stand, tripod, bracket, or table specified by the manufacturer, or sold with the apparatus. When a cart is used, use caution when moving the cart/apparatus combination to avoid injury from tip-over.
13. Unplug this apparatus during lightning storms or when unused for long periods of time.
14. Refer all servicing to qualified service personnel. Servicing is required when the apparatus has been damaged in any way, such as power-supply cord or plug is damaged, liquid has been spilled or objects have fallen into the apparatus, the apparatus has been exposed to rain or moisture, does not operate normally, or has been dropped.
15. To reduce the risk of fire or electric shock, do not expose this apparatus to rain or moisture.
16. Apparatus should not be exposed to dripping or splashing and no objects filled with liquids, should be placed on the apparatus.
17. Use only with the battery which specified by manufacturer.
18. The power supply cord set is to be the main disconnected device.



## **WARNING**

1. **FOR OUTDOOR USE:**  
To reduce the risk of fire or electric shock, do not expose this apparatus to rain or moisture.
2. **UNDER WET LOCATION:**  
Apparatus should not be exposed to dripping or splashing and no objects filled with liquids, such as vases should be placed on the apparatus.
3. **SERVICE INSTRUCTIONS:**  
CAUTION - These servicing instructions are for use by qualified service personnel only. To reduce the risk of electric shock, do not perform any servicing other than that contained in the operating instructions unless you are qualified to do so.

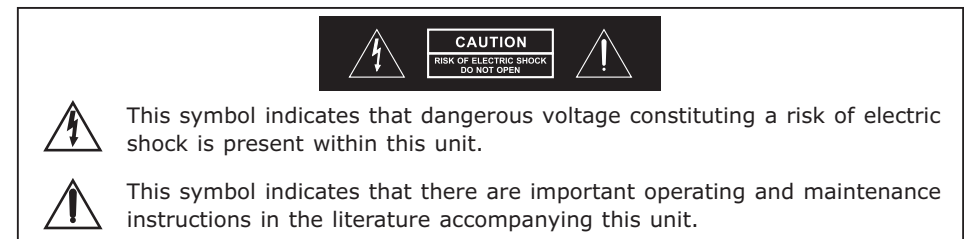

### FCC

THIS DEVICE COMPLIES WITH PART 74 AND PART 15 SUBPART B OF THE FCC RULES OPERATION IS SUBJECT TO THE FOLLOWING TWO CONDITIONS:

- (1) This device may not cause interference.
- (2) This device must accept any interference, including interference that may cause undesired operation of the device.

This equipment complies with FCC RF radiation exposure limits set forth for an uncontrolled environment.

### IC

This device complies with Industry Canada licence-exempt RSS-123 ISSUE 2 / RSS-310 ISSUE 3 standards. Operation is subject to the following two conditions:

- (1) this device may not cause interference, and
- (2) this device must accept any interference, including interference that may cause undesired operation of the device.

Le présent appareil est conforme aux CNR d'Industrie Canada applicables aux appareils radio exempts de licence. L'exploitation est autorisée aux deux conditions suivantes :

- (1) l'appareil ne doit pas produire de brouillage, et
- (2) l'utilisateur de l'appareil doit accepter tout brouillage

radioélectrique subi, même si le brouillage est susceptible d'en compromettre le fonctionnement.

## Contents

- 1 Profile
- 2 Controls and Indicators
- 4 Operating Instructions
- 7 LCD Screen Display
- 8 Menu Navigation
- 13 Battery Indicator



To prevent possible hearing damage, do not listen at high volume levels for long periods.

**Disposal** Dispose of any unusable devices or batteries responsibly and in accordance with any applicable regulations.



2006-08-13

Disposing of used batteries with domestic waste is to be avoided!  
Batteries / NiCad cells often contain heavy metals such as cadmium(Cd), mercury(Hg) and lead(Pb) that makes them unsuitable for disposal with domestic waste. You may return spent batteries/ accumulators free of charge to recycling centres or anywhere else batteries/accumulators are sold.

By doing so, you contribute to the conservation of our environment!

## Profile

Thank you for choosing a MIPRO IEM product.

This industry's first digital IEM system is engineered to meet the stringent requirements demanded in professional touring and installation applications.

Featuring digitally encrypted technology and unparalleled digital audio performance and transmission reliability, superior frequency response characteristics from 20Hz low-frequency sound clearly exceeds analog IEM systems currently on the market.

The MI-909 system consists one MI-909T digital rack unit stereo transmitter and will transmit to one or more MI-909R digital stereo bodypack receivers.

## Notes

1. Refer to actual product in the event of product description discrepancy.
2. Frequency range and maximum deviation comply with the regulations of different countries.

## Bodypack Receiver Controls and Indicators

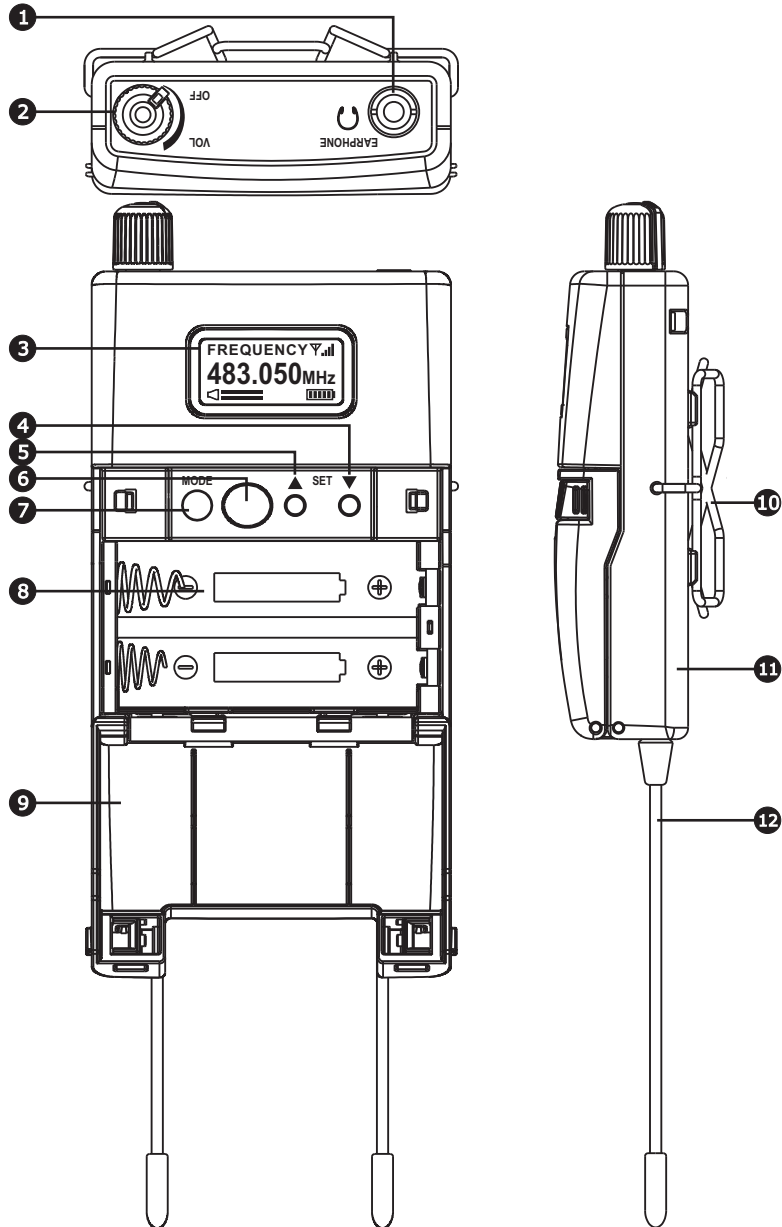

- ❶ **3.5  $\phi$  mm Stereo Earphone Jack:** Insertion stereo earphones here.
- ❷ **Power Switch and Volume Control:** Turns the bodypack on and off and adjusts earphone volume.
- ❸ **LCD Screen:** Displays current settings and menus.
- ❹ **SET  $\nabla$  Button:** To change (decrease) settings.
- ❺ **SET  $\blacktriangle$  Button:** To change (increase) settings.
- ❻ **ACT Sync Window:** For automatic frequency synchronization from transmitter.
- ❼ **MODE button:** To select function for setup.
- ❽ **Battery Compartment:** Requires 2 AA batteries.
- ❾ **Battery Compartment Door:** Open by pressing the latches on both sides and pulling.
- ❿ **Belt Clip:** Securely attaches to belts.
- ⓫ **Housing:** protects internal PCB.
- ⓬ **A/B Antenna:** Dual soft antennas.

(Standard)

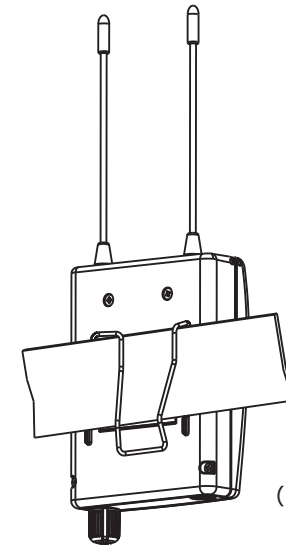
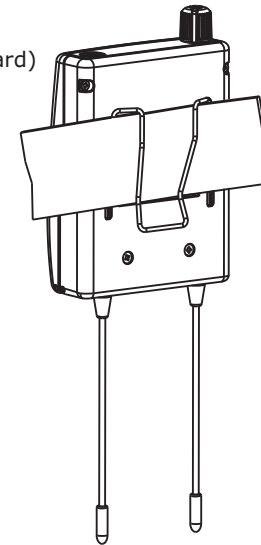

(Reverse)

## Operating Instructions

### 1. Battery Requirement

- ① MI-909R requires 2 AA alkaline batteries or higher capacity AA NiMH Rechargeable battery. Stand-by hours for alkaline batteries are over 6 hours. Unit automatically shuts down and turns off with a display warning "OFF" when low voltage reaches approximately 1.8V to protect batteries from leakage or damage.

### 2. Battery Insertion

- ① Open by pressing the latches on both sides and pulling.
- ② Insert the batteries according to its correct polarity.

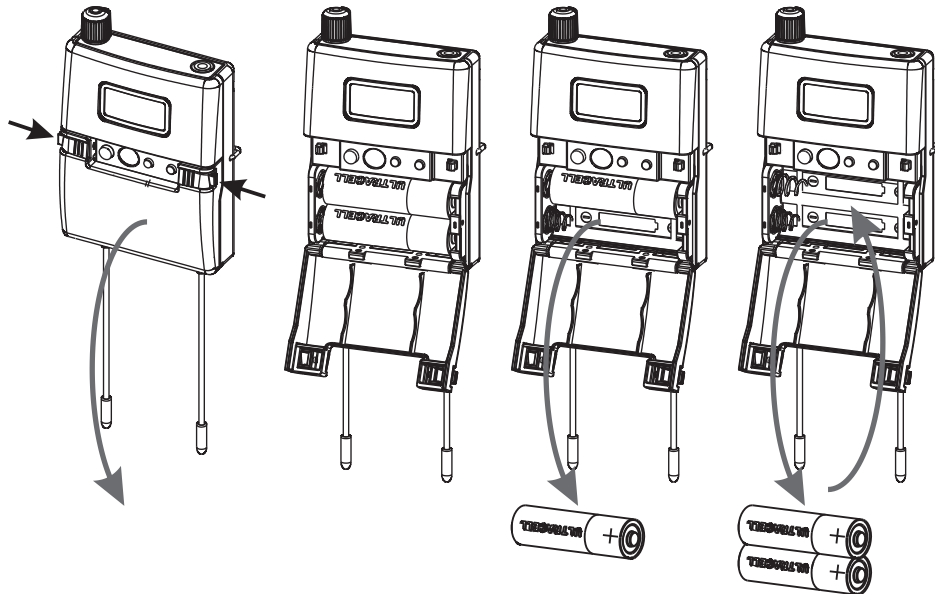

**Note:**

Remove the batteries when is not used for a long time and to prevent damaging to the electronics due to battery leak.

### 3. Earphones Insertion

- ① Insert any 3.5  $\phi$  mm stereo earphones here or connect to the audio input of other audio equipment.

**Note:**

Insert stereo earphones only to prevent possible short-circuiting.

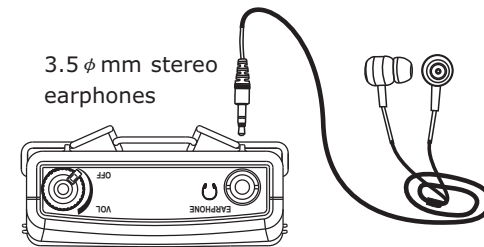

**Warning: Avoiding Hearing Damage -**

Permanent noise-induced hearing loss may occur on prolonged exposure to loud sounds wearing earphones or headphones. We recommend you listen responsibly by limiting the amount of time that you use earphones or headphones at high volume.

#### 4. Power & Volume Control

- ① Turn the unit on. The backlight will dim automatically after 5 seconds to save power.
- ② Adjust for desired earphone volume after is powered on. Warning display OFF appears briefly after the unit is turned off.

Power On:

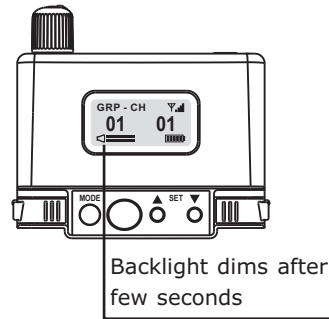
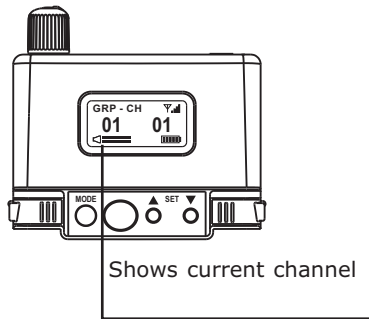

Power Off:

Warning display OFF

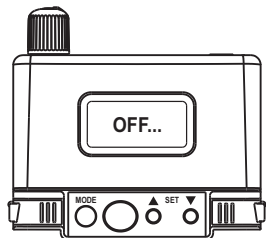

Completely off

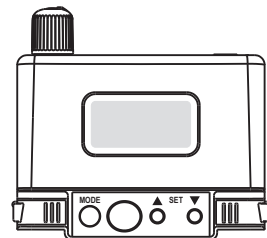

Note:

Unit will not power on with weak battery power or incorrect polarity battery insertion.

#### LCD Screen Display

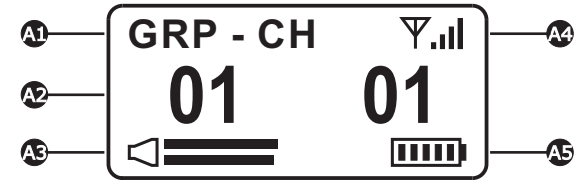

**A1** GRP (Group); CH (Channel)

**A2** Numeric Group & Channel

**A3** Audio Indicator: Top bar is left channel. Bottom bar is right channel.

**A4** Antenna Signal Indicator

**A5** Battery Indicator

## Menu Navigation

### 1. MODE Setting: 6 mode settings

- ① Press MODE button to select one of the six selections.
- ② Backlight dims in 5 seconds in each mode.

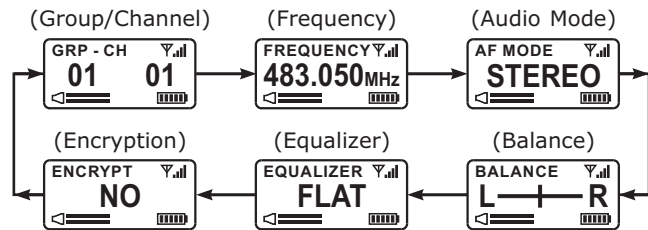

### 2. SET ▲ or SET ▼ button: Use to change parameters

- ① When SET ▲ or SET ▼ button is pressed and released, backlight flashes and displays current setting for approximately 5 seconds to denote it is ready to accept change. Once a successfully change is made the setting is automatically saved. The backlight flashing on the screen will generally "time out" after five seconds.
- ② SET ▲ button: Press & release to increase.
- ③ SET ▼ button: Press & release to decrease.

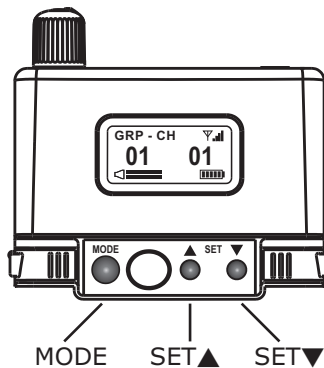

### 3. GROUP / CHANNEL MODE

- ① When SET ▲ or SET ▼ button is pressed and released, backlight flashes and displays current setting for approximately 5 seconds to denote it is ready to accept change.
- ② Press and release SET ▲ or SET ▼ button to change setting of GRP or CH. Once a successfully change is made the setting is automatically saved. The backlight flashing on the screen will generally "time out" after five seconds.



### 4. FREQUENCY MODE

- ① When SET ▲ or SET ▼ button is pressed and released, backlight flashes and displays current setting for approximately 5 seconds to denote it is ready to accept change.
- ② Press and release SET ▲ or SET ▼ button to change setting of FREQUENCY. Once a successfully change is made the setting is automatically saved. The backlight flashing on the screen will generally "time out" after five seconds.
- ③ Frequency selection: adjustable in increments of 1 MHz or 25 kHz.



### 5. AF (Audio) MODE

- ① When SET ▲ or SET ▼ button is pressed and released, backlight flashes and displays current setting for approximately 5 seconds to denote it is ready to accept change.
- ② Press and release SET ▲ or SET ▼ button to change setting of AF MODE. Once a successfully change is made the setting is automatically saved. The backlight flashing on the screen will generally "time out" after five seconds.

#### ③ AF MODE Settings

**STEREO:** Stereo Output.

**MONO-L:** Mono Left Channel Output.

**MONO-R:** Mono Right Channel Output.

**MIXED:** Mixed Left Right Channel Output.

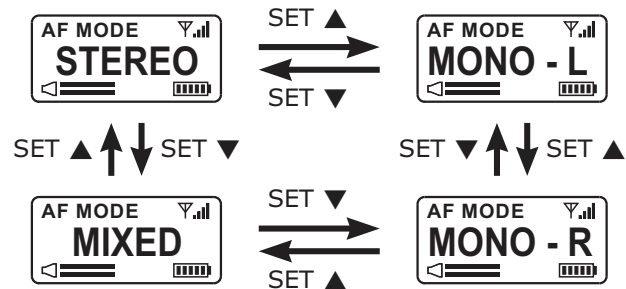

### 6. BALANCE MODE

- ① When SET ▲ or SET ▼ button is pressed and released, backlight flashes and displays current setting for approximately 5 seconds to denote it is ready to accept change.
- ② Press and release SET ▲ or SET ▼ button to change setting of BALANCE to L or R. Once a successfully change is made the setting is automatically saved. The backlight flashing on the screen will generally "time out" after five seconds.
- ③ When indicator moves to the left towards (L) this indicate left channel audio increases. When indicator moves to the right towards (R) this indicate right channel audio increases.



### 7. EQUALIZER MODE

- ① When SET ▲ or SET ▼ button is pressed and released, backlight flashes and displays current setting for approximately 5 seconds to denote it is ready to accept change.
- ② Press and release SET ▲ or SET ▼ button to change setting of EQUALIZER. Once a successfully change is made the setting is automatically saved. The backlight flashing on the screen will generally "time out" after five seconds.

#### ③ EQUALIZER Settings

**FLAT:** Flat Response

**LO-CUT:** Low Frequency Cut

**HI-BST:** High Frequency Boost

**LC&HB:** Low Cut & High Boost

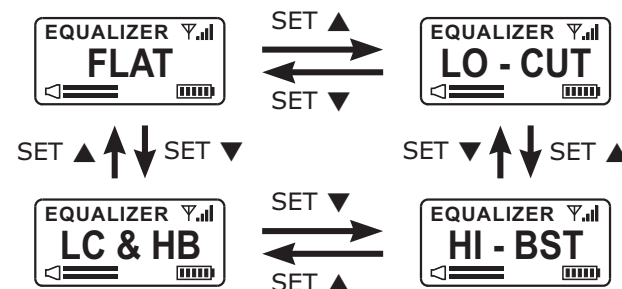



## 8. ENCRYPTION MODE

- ① Encryption mode cannot be set via SET ▲ or SET ▼ button. The encryption key is setup at the transmitter and setting transfer to the bodypack receiver during synchronization (ACT sync).
- ② ENCRYPT mode  
**YES** denotes the receiver is encrypted.  
**NO** denotes the receiver is not encrypted.

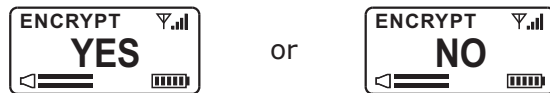

## Sync (ACT)

Bodypack receiver frequency settings comes from rack unit transmitter and can be synchronized automatically easily and quickly.

1. Ensure antenna on the transmitter is installed properly.
2. Press the ACT (sync) button on the transmitter.
3. Align the ACT sync windows of both transmitter and receiver within 30cm (12-inch) to synchronize the frequencies automatically while the transmitter display is flashing "ACT SYNC...".
4. After a successful sync, the RF bar on the receiver illuminates.
5. If the synchronization is done unsuccessfully the word "ACT FAIL" appears. Repeat all steps.

Note: See Transmitter user guide for performing SCAN & ACT sync functions.

## 9. Battery Indicator

- ① Replace and install fresh/new batteries when battery indicator shows one bar (20%) or zero (10%) remaining. Unit automatically shuts down and turns off during very low voltage to protect batteries from leakage or damage.

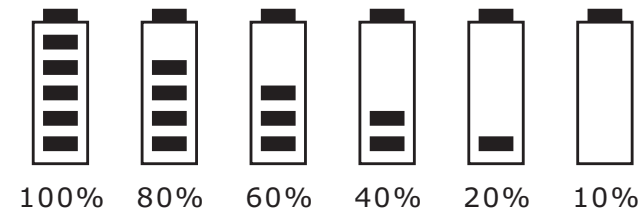

## 10. Error Codes

- ① ERROR1→RF frequency lock circuit fault.
- ② ERROR3→During ACT sync ~ the frequency bands between transmitter and receiver are different and not compatible. Press MODE button or reset by power off.
- ③ ERROR4→During ACT sync ~ the frequency bands between transmitter and receiver are different and not compatible. Press MODE button or reset by power off.

## Note

1. Using AA alkaline or higher performance batteries are recommended.
2. Avoid using the same frequency bands when MIPRO IEM and wireless microphone systems are utilized at the same installation.
3. Using different impedance earphones, different battery types, high monitoring volume, cold/high temperature and higher gain settings may cause the receiver battery life to be different than specified. Earphones with sensitivity over 110dB/mW are recommended.
4. Remove the batteries when is not used for a long time and to prevent damaging to the electronics due to battery leak.
5. Refer to actual product in the event of product description discrepancy.
6. Frequency range and maximum deviation comply with the regulations of different countries.