



Digital Projector Installation Guide

Installation Projector | LU9750/LU9800

數位投影機安裝指南

数码投影机安装指南

Guide d'installation du projecteur numérique

Digitalprojektor Installationsanleitung

Guida all'installazione del proiettore digitale

Руководство по установке цифрового проектора

디지털 프로젝터 설치 안내서

デジタルプロジェクタインストールガイド

Table of Contents

Notice	2
Notice on laser	2
Cooling notice	3
Product information	5
Packing content.....	5
Specification	5
Terminals	6
Remote control	7
Installation	9
Installing removing the optional lens.....	9
Lens	11
Projection table.....	11
Lens shift range	13
LED indicator	15
System message.....	15
Light source error message	15
Filter message	15
Thermal error message.....	16
Projector dimension	17
Ceiling mount installation diagram.....	18
Size and angle adjustment	18
Lens dimension.....	19
RS232 command	20
RS232 pin assignment.....	20
RS232 serial port with a crossover cable.....	20

Please visit below website for latest version of User Manual / Installation Guide.

<http://business-display.benq.com/>

Notice

Notice on laser



This symbol indicates that there is a potential hazard of eye exposure to laser radiation unless the instructions are closely followed.

• Laser class



(for USA) This Laser Product is designated as Class 3R during all procedures of operation and complies with IEC/EN 60825-1:2007.

(for WW) This Laser Product is designated as Class I during all procedures of operation and complies with IEC/EN 60825-1:2014.

LASER LIGHT - AVOID DIRECT EYE EXPOSURE.



Do not point laser or allow laser light to be directed or reflected toward other people or reflective objects.

Direct or scattered light can be hazardous to eyes and skin.

There is a potential hazard of eye exposure to laser radiation if the included instructions are not followed.

Caution – use of controls or adjustments or performance of procedures other than those specified herein may result in hazardous radiation exposure.

• Laser parameters

Wavelength	449nm - 461nm (Blue)
Mode of operation	Pulsed, due to frame rate
Pulse width	1.34ms
Pulse repetition rate	120Hz
Maximum laser energy	0.698mj
Total internal power	>100w
Apparent source size	>10mm, at lens stop
Divergence	>100 mili Radian

• Laser light instruction

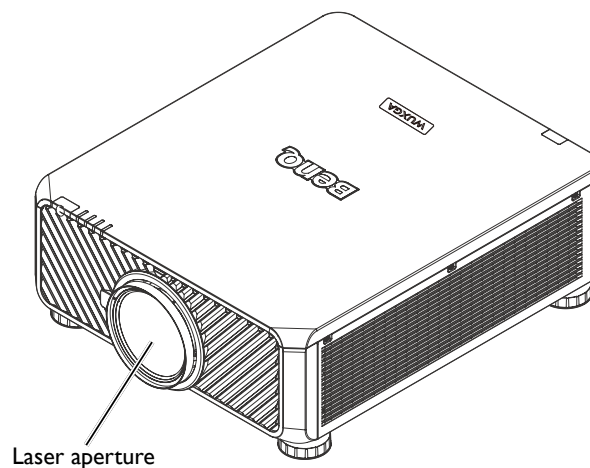

Risk Group 3 Information

- **Light hazard warning**



Failure to comply with the following may result in serious injury:

- No direct exposure to the beam is permitted, RG3 IEC 62471-5:2015.
- Operators control access to the beam within the hazard distance or install the projector at sufficient height to prevent exposures of spectators' eyes within the hazard distance.

The hazard distance is the distance measured from the projection lens at which the intensity or energy per unit of surface is lower than the applicable exposure limit on the cornea or skin. If the person is within the hazard distance, the beam is considered unsafe for exposure.

The hazard distance for this projector is 0-150 cm.

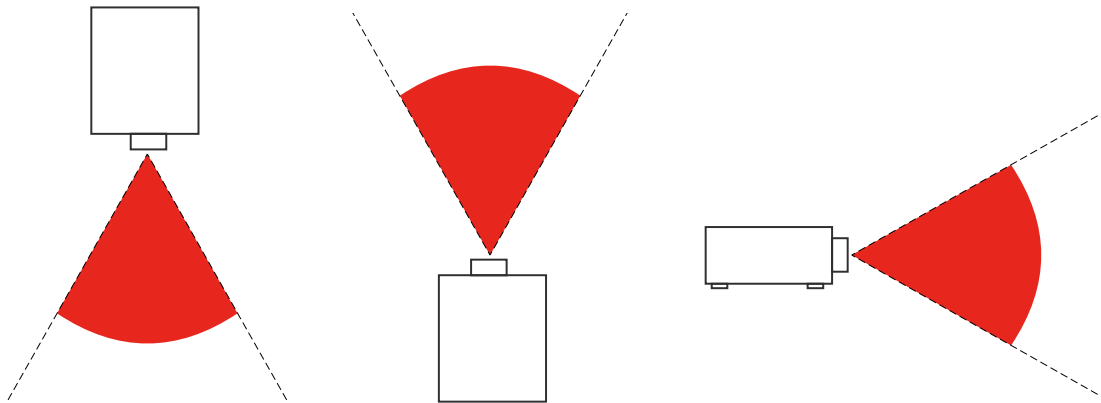

- **Note**

This projector is an RG3 product, which must be installed in a safe place and must be handled by qualified and professionally skill trained personnel

For the installation and removal of the lens, please consult your dealer with qualified profession-als to install it. Do not try to install the projector yourself, otherwise your eyesight may be dam-aged

In case to install the projector over head, keep over 3m distance at least between the floor surface and the RG3 area. Operators shall control access to the beam within the hazard distance or install the product at the height that will prevent exposures of spectators' eyes within the hazard distance.

-

- **Caution:**

Use of controls, adjustments or performance of procedures other than those specified herein may result in hazardous laser light exposure.

Cooling notice

Allow at least 50 cm (19.7 inch) for clearance around the exhaust vent. Make sure no objects block air input within 30 cm (11.8 inch).

Keep the outlet at least 1 m away from the inlets of other projectors.

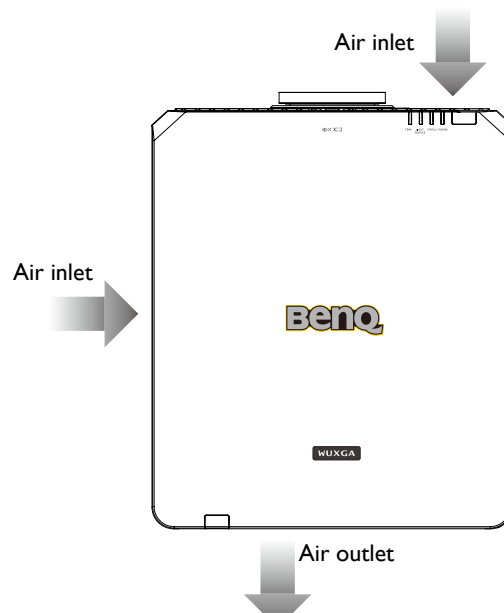

- The projector can be installed at any angle.



- Allow at least 50 cm of clearance around the exhaust vent.

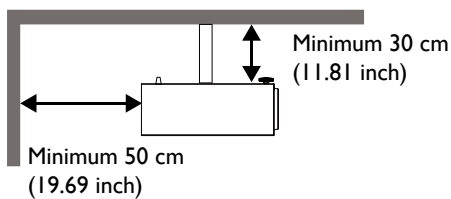
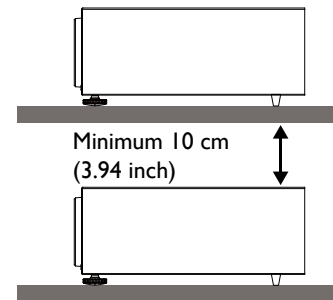
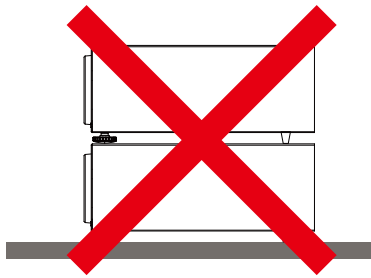
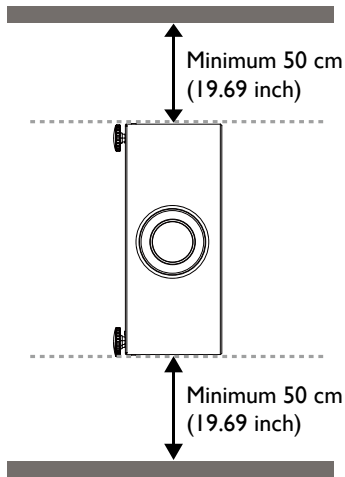
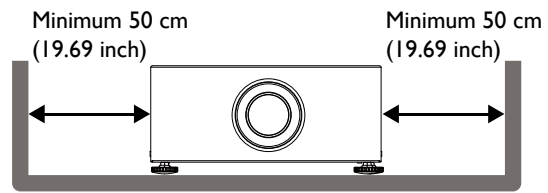
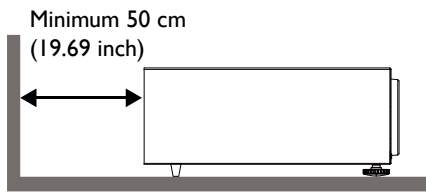

- Ensure that the air intake vents do not recycle hot air from the exhaust vent.
- When operating in an enclosed space, make sure that the surrounding air temperature does not exceed the projector's operating temperature and that the air intake and exhaust vents are unobstructed.
- All enclosures should pass a certified thermal evaluation to ensure that the projector does not recycle exhaust air. Recycling exhaust air may cause the projector to shutdown even if the ambient temperature is within the acceptable operating temperature range.

Product information

Packing content

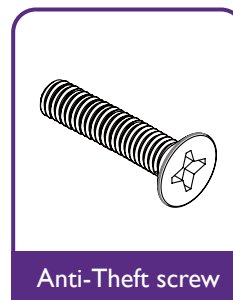
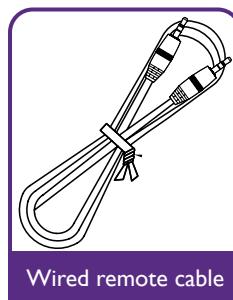
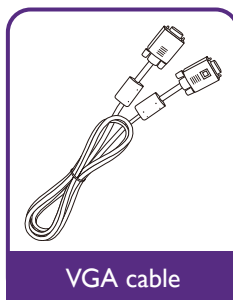
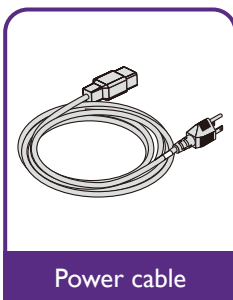
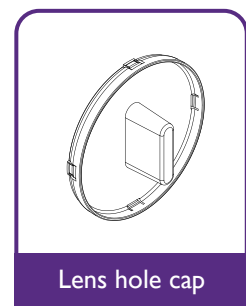
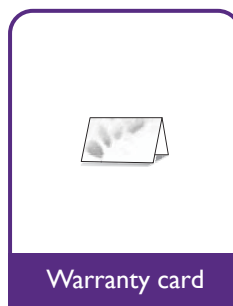

Specification

	LU9750	LU9800
Projection system	DLP Single 0.67 WUXGA DMD Chip	
Native resolution	1920*1200 pixels, 16:10	
Light source	Laser Package	
Power consumption	792W(typ);0.5W(standby)	893W(typ);0.5W(standby)
Dimension	470 x 220.5 x 519.5 mm	
Weight	26.4 kg (without lens)	26.8 kg (without lens)

Note:

- The brightness is supplied by standard lens, the value will depends on lenses.
- The brightness output will vary depending on each units and actual usage.
- Please find the latest user's manual on the local website.

Terminals

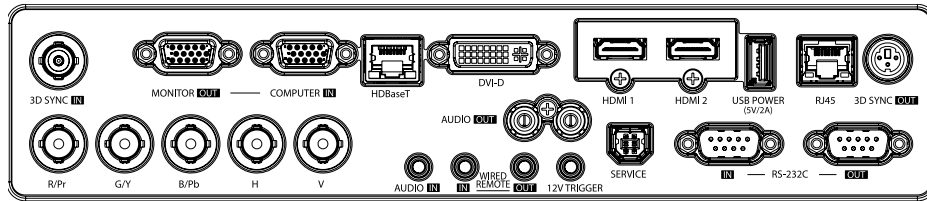

3D SYNC IN

Connect 3D-sync in cable from a computer or an enabled device.

MONITOR OUT

Connection to other display equipment for concurrent playback display.

COMPUTER IN

15-pin VGA port for connection to RGB, component HD source, or PC.

HDBaseT

Connect an Ethernet cable (Cat5/Cat6) from HDBaseT transmitter with high-definition video (HD), RS232 control and LAN control.

DVI-D

Connection to DVI source.

HDMI 1

Connection to HDMI source.

HDMI 2

Connection to HDMI source.

USB POWER 2A

Support 5V/2A output.

RJ45

For connection to RJ45 Cat5/Cat6 Ethernet cable to control the projector through a network.

3D SYNC OUT

Connection to 3D IR sync signal transmitter.

RS-232 IN

Standard 9-pin D-sub interface for connection to PC control system and projector maintenance.

RS-232 OUT

Connects to another projector (same model) for RS-232 control.

SERVICE

Maintenance exclusive port for authorized maintenance personnel only.

AUDIO OUT (L/R)

Connection to a speaker or headset.

12V TRIGGER

3.5mm mini earphone jack, employs 200mA display relay to provide 12(+/-1.5)V output and short circuit protection.

WIRED REMOTE IN

Connection to remote control for wire remote control.

WIRED REMOTE OUT

Connection to another projector.

AUDIO IN

Connection to an audio input source via an audio cable.

R/Pr, G/Y, B/Pb, H, V

Connection to RGB or YPbPr/YCbCr output signal with BNC type input terminal.

Caution:

Make sure the port is valid before inserting a wired remote controller. The remote controller may be damaged in case of an invalid port, e.g. a wired remote controller is connected to trigger output. For more information about upgrading firmware via Lan, please contact BenQ service.

Remote control

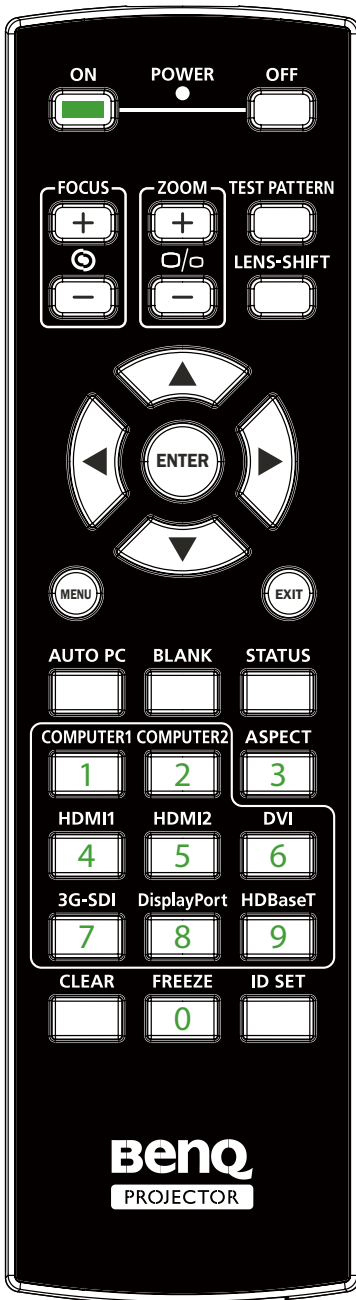

ON

Press to power on projector.

OFF

Press to power off projector.

FOCUS +/-

Press to adjust focus of projection image.

ZOOM +/-

Press to zoom in and out on projection image.

TEST PATTERN

Press to display embedded test pattern. Press continuously to scroll through available ones. Press MENU key to exit to projection image.

LENS SHIFT

Press to move lens up, down, left and right.

ENTER

Press to select or accept settings.

MENU

Press to display OSD menu or return to the upper menu level.

EXIT

Press to exit OSD menu.

AUTO PC

Press to execute auto signal sync.

BLANK

Press the button to temporarily interrupt the projection.

STATUS

Show OSD MENU – Information.

COMPUTER 1

Select COMPUTER 1 input source.

COMPUTER 2

Select COMPUTER 2 input source.

ASPECT

Press continuously to scroll through individual aspect ratio.

HDMI 1

Select HDMI 1 input source.

HDMI 2

Function same as HDMI 1.

DVI

Select DVI input source.

3G-SDI

Select 3G-SDI input source.

DisplayPort

Select DisplayPort input source.

HDBaseT

Select HDBaseT input source.

CLEAR

Not available with this model.

FREEZE

Press to toggle switch between freeze and unfreeze.

ID SET:

Not available for this model.

Installation

Caution:

To avoid damaging the DLP chips, never aim a high-power laser beam into the projection lens.

Installing removing the optional lens

Caution:

- Do not shake or place excessive pressure on the projector or the lens components as the projector and lens components contain precision parts.
- Before removing or installing the lens, be sure to turn off the projector, wait until the cooling fans stop, and turn off the main power switch.
- Do not touch the lens surface when removing or installing the lens.
- Keep fingerprints, dust or oil off the lens surface. Do not scratch the lens surface.
- Work on a level surface with a soft cloth under it to avoid scratching.
- If you remove and store the lens, attach the lens cap to the projector to keep off dust and dirt.

• Installing the new lens

Remove both end caps from the lens.

Note:

Removal of the plastic body cap before inserting a lens for the first time.

1. Orient the lens so that the arrow on the label pasted on its side is facing upward and push the lens into the lens mount of the unit as far as it will go.

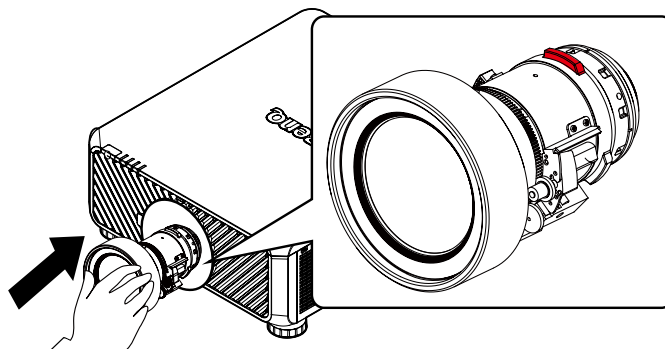

2. Rotate the lens clockwise until you feel it click into place.

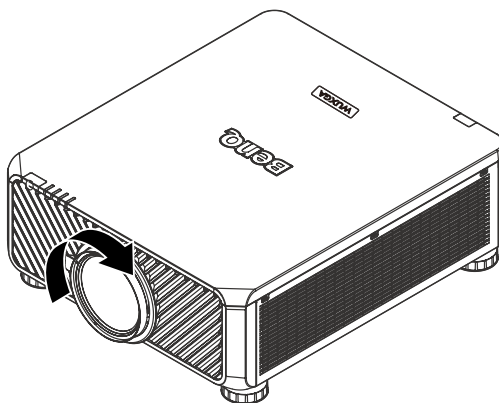

- **Removing the existing lens from the projector**

1. Push the LENSE RELEASE button to the unlock position.

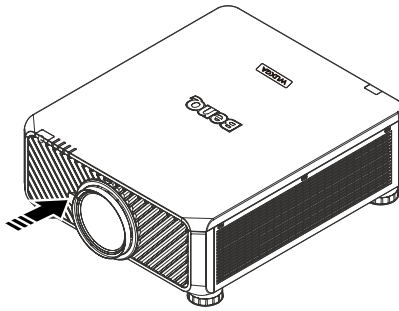

2. Grasp the lens.
3. Rotate the lens counterclockwise. The existing lens will be disengaged.

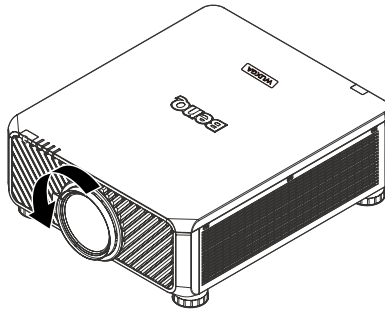

4. Pull out the existing lens slowly.

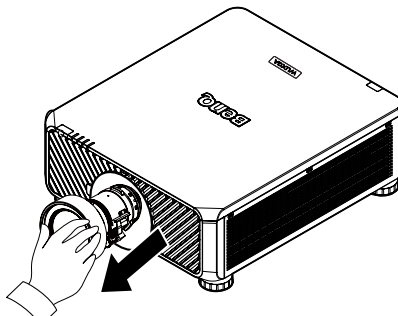

Lens

Model	Lens Type	Part Number	Throw Ratio	Lens Shift
LSIST3A	Short throw	5J.JPN37.001	WUXGA: 0.77-1.1	Vertical: -15%-55% Horizontal: -5%-5%
LSIST2A	Wide zoom 2	5J.JPN37.002	WUXGA: 1.1-1.3	Vertical: -15%-55% Horizontal: -5%-5%
LSIST1A	Wide zoom 1	5J.JPN37.003	WUXGA: 1.25-1.6	Vertical: -15%-55% Horizontal: -5%-5%
LSISDA	Standard	5J.JPN37.004	WUXGA: 1.54-1.93	Vertical: -15%-55% Horizontal: -5%-5%
LSILT0	Semi long	5J.JPN37.005	WUXGA: 1.93-2.9	Vertical: -15%-55% Horizontal: -5%-5%
LSILT1	Semi Long 2	5J.JAM37.051	WUXGA: 2.22-3.67	Vertical: -15%-55% Horizontal: -5%-5%
LSILT2	Long Zoom 1	5J.JAM37.031	WUXGA: 3.58-5.38	Vertical: -15%-55% Horizontal: -5%-5%
LSILT3	Long Zoom 2	5J.JAM37.041	WUXGA: 5.31~8.26	Vertical: -15%-55% Horizontal: -5%-5%
LSIST4	Ultra Short throw	5J.JCY37.001	WUXGA: 0.377	Vertical: -0%-0% Horizontal: -0%-0%

Projection table

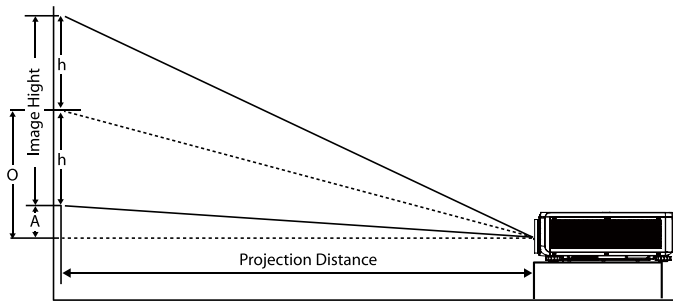
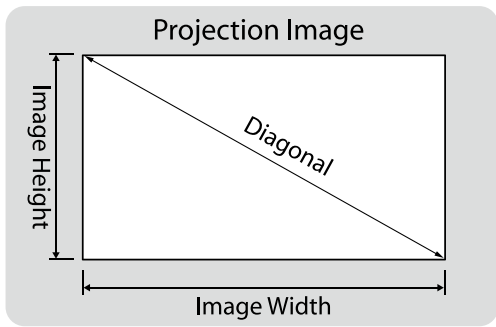

*** "A" is based on maximum lens shift offset position 55%

• LU9750/LU9800

The screen aspect ratio is 16:10 and the projected picture is 16:10.

Note:

To optimize the projection quality, we suggest to project images in an area without grayscale.

Lens										Wide Zoom 2 (LS2ST2A)				Standard (LSISDA)			
Throw ratio										1.1~1.3				1.54~1.93			
Diagonal		Image Width		Image Height		Offset (A)		O		Distance				Distance			
						Wide/Tele		Wide/Tele		Wide		Tele		Wide		Tele	
(Inch)	(m)	(Inch)	(m)	(Inch)	(m)	(Inch)	(m)	(Inch)	(m)	(Inch)	(m)	(Inch)	(m)	(Inch)	(m)	(Inch)	(m)
50	1.27	42	1.08	26	0.67	1.3	0.034	14.6	0.370	47	1.18	55	1.40	65	1.66	82	2.08
60	1.52	51	1.29	32	0.81	1.6	0.040	17.5	0.444	56	1.42	66	1.68	78	1.99	98	2.49
80	2.03	68	1.72	42	1.08	2.1	0.054	23.3	0.592	75	1.90	88	2.24	104	2.65	131	3.33
100	2.54	85	2.15	53	1.35	2.6	0.067	29.1	0.740	93	2.37	110	2.80	131	3.32	164	4.16
120	3.05	102	2.58	64	1.62	3.2	0.081	35.0	0.888	112	2.84	132	3.36	157	3.98	196	4.99
150	3.81	127	3.23	79	2.02	4.0	0.101	43.7	1.111	140	3.55	165	4.20	196	4.98	245	6.24
180	4.57	153	3.88	95	2.42	4.8	0.121	52.5	1.333	168	4.26	198	5.04	235	5.97	295	7.48
200	5.08	170	4.31	106	2.69	5.3	0.135	58.3	1.481	187	4.74	220	5.60	261	6.63	327	8.31
250	6.35	212	5.38	132	3.37	6.6	0.168	72.9	1.851	233	5.92	276	7.00	326	8.29	409	10.39
300	7.62	254	6.46	159	4.04	7.9	0.202	87.4	2.221	280	7.11	331	8.40	392	9.95	491	12.47
350	8.89	297	7.54	185	4.71	9.3	0.236	102.0	2.591	326	8.29	386	9.80	457	11.61	573	14.55
400	10.16	339	8.62	212	5.38	10.6	0.269	116.6	2.962	373	9.48	441	11.20	522	13.27	655	16.63
500	12.70	424	10.77	265	6.73	13.2	0.337	145.7	3.702	466	11.85	551	14.00	653	16.59	818	20.79

Lens										Short Throw (LS1ST3A)				Semi Throw (LS2ST4)			
Throw ratio										0.77~1.1				1.25~1.60			
Diagonal		Image Width		Image Height		Offset (A)		O		Distance				Distance			
						Wide/Tele		Wide/Tele		Wide		Tele		Wide		Tele	
(Inch)	(m)	(Inch)	(m)	(Inch)	(m)	(Inch)	(m)	(Inch)	(m)	(Inch)	(m)	(Inch)	(m)	(Inch)	(m)	(Inch)	(m)
50	1.27	42	1.08	26	0.67	1.3	0.034	14.6	0.370	33	0.83	47	1.18	53	1.35	68	1.72
60	1.52	51	1.29	32	0.81	1.6	0.040	17.5	0.444	39	1.00	56	1.42	64	1.62	81	2.07
80	2.03	68	1.72	42	1.08	2.1	0.054	23.3	0.592	52	1.33	75	1.90	85	2.15	109	2.76
100	2.54	85	2.15	53	1.35	2.6	0.067	29.1	0.740	65	1.66	93	2.37	106	2.69	136	3.45
120	3.05	102	2.58	64	1.62	3.2	0.081	35.0	0.888	78	1.99	112	2.84	127	3.23	163	4.14
150	3.81	127	3.23	79	2.02	4.0	0.101	43.7	1.111	98	2.49	140	3.55	159	4.04	204	5.17
180	4.57	153	3.88	95	2.42	4.8	0.121	52.5	1.333	118	2.99	168	4.26	191	4.85	244	6.20
200	5.08	170	4.31	106	2.69	5.3	0.135	58.3	1.481	131	3.32	187	4.74	212	5.38	271	6.89
250	6.35	212	5.38	132	3.37	6.6	0.168	72.9	1.851	163	4.15	233	5.92	265	6.73	339	8.62
300	7.62	254	6.46	159	4.04	7.9	0.202	87.4	2.221	196	4.98	280	7.11	318	8.08	407	10.34
350	8.89	297	7.54	185	4.71	9.3	0.236	102.0	2.591	229	5.80	326	8.29	371	9.42	475	12.06
400	10.16	339	8.62	212	5.38	10.6	0.269	116.6	2.962	261	6.63	373	9.48	424	10.77	543	13.79
500	12.70	424	10.77	265	6.73	13.2	0.337	145.7	3.702	326	8.29	466	11.85	530	13.46	678	17.23

Lens										Semi Long (LSILT0)			
Throw ratio										1.93~2.9			
Diagonal		Image Width		Image Height		Offset (A)		O		Distance			
						Wide/Tele		Wide/Tele		Wide		Tele	
(Inch)	(m)	(Inch)	(m)	(Inch)	(m)	(Inch)	(m)	(Inch)	(m)	(Inch)	(m)	(Inch)	(m)
50	1.27	42	1.08	26	0.67	1.3	0.034	14.6	0.370	82	2.08	123	3.12
60	1.52	51	1.29	32	0.81	1.6	0.040	17.5	0.444	98	2.49	148	3.75
80	2.03	68	1.72	42	1.08	2.1	0.054	23.3	0.592	131	3.33	197	5.00
100	2.54	85	2.15	53	1.35	2.6	0.067	29.1	0.740	164	4.16	246	6.25
120	3.05	102	2.58	64	1.62	3.2	0.081	35.0	0.888	196	4.99	295	7.50
150	3.81	127	3.23	79	2.02	4.0	0.101	43.7	1.111	245	6.24	369	9.37
180	4.57	153	3.88	95	2.42	4.8	0.121	52.5	1.333	295	7.48	443	11.24
200	5.08	170	4.31	106	2.69	5.3	0.135	58.3	1.481	327	8.31	492	12.49
250	6.35	212	5.38	132	3.37	6.6	0.168	72.9	1.851	409	10.39	615	15.62
300	7.62	254	6.46	159	4.04	7.9	0.202	87.4	2.221	491	12.47	738	18.74
350	8.89	297	7.54	185	4.71	9.3	0.236	102.0	2.591	573	14.55	861	21.86
400	10.16	339	8.62	212	5.38	10.6	0.269	116.6	2.962	655	16.63	984	24.99
500	12.70	424	10.77	265	6.73	13.2	0.337	145.7	3.702	818	20.79	1230	31.23

Lens										Semi Long 2 (LSILT1)				Long Zoom 1 (LSILT2)			
Throw ratio										2.22~3.67				3.58-5.38			
Diagonal		Image Width		Image Height		Offset (A)		O		Distance				Distance			
						Wide/Tele		Wide/Tele		Wide		Tele		Wide		Tele	
(Inch)	(m)	(Inch)	(m)	(Inch)	(m)	(Inch)	(m)	(Inch)	(m)	(Inch)	(m)	(Inch)	(m)	(Inch)	(m)		
50	1.27	42	1.08	26	0.67	0.0	0.000	13.2	0.337	94	2.39	156	3.95	152	3.86	228	5.79
60	1.52	51	1.29	32	0.81	0.0	0.000	15.9	0.404	113	2.87	187	4.74	182	4.63	274	6.95
80	2.03	68	1.72	42	1.08	0.0	0.000	21.2	0.538	151	3.83	249	6.32	243	6.17	365	9.27
100	2.54	85	2.15	53	1.35	0.0	0.000	26.5	0.673	188	4.78	311	7.90	304	7.71	456	11.59
120	3.05	102	2.58	64	1.62	0.0	0.000	31.8	0.808	226	5.74	373	9.49	364	9.25	547	13.91
150	3.81	127	3.23	79	2.02	0.0	0.000	39.7	1.010	282	7.17	467	11.86	455	11.57	684	17.38
180	4.57	153	3.88	95	2.42	0.0	0.000	47.7	1.212	339	8.61	560	14.23	546	13.88	821	20.86
200	5.08	170	4.31	106	2.69	0.0	0.000	53.0	1.346	377	9.56	622	15.81	607	15.42	912	23.18
250	6.35	212	5.38	132	3.37	0.0	0.000	66.2	1.683	471	11.95	778	19.76	759	19.28	1141	28.97
300	7.62	254	6.46	159	4.04	0.0	0.000	79.5	2.019	565	14.35	934	23.71	911	23.13	1369	34.76
350	8.89	297	7.54	185	4.71	0.0	0.000	92.7	2.356	659	16.74	1089	27.67	1063	26.99	1597	40.56
400	10.16	339	8.62	212	5.38	0.0	0.000	106.0	2.692	753	19.13	1245	31.62	1214	30.84	1825	46.35
500	12.70	424	10.77	265	6.73	0.0	0.000	132.5	3.365	941	23.91	1556	39.52	1518	38.56	2281	57.94

Lens										Long Zoom 2 (LSILT3)			
Throw ratio										5.31~8.26			
Diagonal		Image Width		Image Height		Offset (A)		O		Distance			
						Wide/Tele		Wide/Tele		Wide		Tele	
(Inch)	(m)	(Inch)	(m)	(Inch)	(m)	(Inch)	(m)	(Inch)	(m)	(Inch)	(m)	(Inch)	(m)
50	1.27	42	1.08	26	0.67	0.0	0.000	13.2	0.337	225	5.72	350	8.90
60	1.52	51	1.29	32	0.81	0.0	0.000	15.9	0.404	270	6.86	420	10.67
80	2.03	68	1.72	42	1.08	0.0	0.000	21.2	0.538	360	9.15	560	14.23
100	2.54	85	2.15	53	1.35	0.0	0.000	26.5	0.673	450	11.44	700	17.79
120	3.05	102	2.58	64	1.62	0.0	0.000	31.8	0.808	540	13.72	841	21.35
150	3.81	127	3.23	79	2.02	0.0	0.000	39.7	1.010	675	17.16	1051	26.69
180	4.57	153	3.88	95	2.42	0.0	0.000	47.7	1.212	811	20.59	1261	32.02
200	5.08	170	4.31	106	2.69	0.0	0.000	53.0	1.346	901	22.87	1401	35.58
250	6.35	212	5.38	132	3.37	0.0	0.000	66.2	1.683	1126	28.59	1751	44.48
300	7.62	254	6.46	159	4.04	0.0	0.000	79.5	2.019	1351	34.31	2101	53.37
350	8.89	297	7.54	185	4.71	0.0	0.000	92.7	2.356	1576	40.03	2452	62.27
400	10.16	339	8.62	212	5.38	0.0	0.000	106.0	2.692	1801	45.75	2802	71.17
500	12.70	424	10.77	265	6.73	0.0	0.000	132.5	3.365	2251	57.19	3502	88.96

Lens										Ultra Short Throw (LSIST4)	
Throw ratio										0.377	
Diagonal		Image Width		Image Height		Offset (A)		O		Distance	
						Wide/Tele		Wide/Tele		Wide	
(Inch)	(m)	(Inch)	(m)	(Inch)	(m)	(Inch)	(m)	(Inch)	(m)	(Inch)	(m)
50	1.27	42	1.08	26	0.67	12.1	0.306	25.3	0.643	16	0.41
60	1.52	51	1.29	32	0.81	14.5	0.368	30.4	0.771	19	0.49
80	2.03	68	1.72	42	1.08	19.3	0.490	40.5	1.028	26	0.65
100	2.54	85	2.15	53	1.35	24.1	0.613	50.6	1.286	32	0.81
120	3.05	102	2.58	64	1.62	28.9	0.735	60.7	1.543	38	0.97
150	3.81	127	3.23	79	2.02	36.2	0.919	75.9	1.928	48	1.22
180	4.57	153	3.88	95	2.42	43.4	1.103	91.1	2.314	58	1.46
200	5.08	170	4.31	106	2.69	48.2	1.225	101.2	2.571	64	1.62
250	6.35	212	5.38	132	3.37	60.3	1.531	126.5	3.214	80	2.03
300	7.62	254	6.46	159	4.04	72.3	1.838	151.8	3.857	96	2.44
350	8.89	297	7.54	185	4.71	84.4	2.144	177.2	4.500	112	2.84
400	10.16	339	8.62	212	5.38	96.5	2.450	202.5	5.142	128	3.25
500	12.70	424	10.77	265	6.73	120.6	3.063	253.1	6.428	160	4.06

 **Note:**

There is 5% tolerance among these numbers due to optical component variations. BenQ recommends that if you intend to permanently install the projector, you should physically test the projection size and distance using the actual projector before you permanently install it, so as to make allowance for this projector's optical characteristics. This will help you determine the exact mounting position so that it best suits your installation location.

Lens shift range

- **Lens shift adjustable range**

The adjustable range for lens shift is tabulated below and subject to the conditions listed.

- **LU9750/LU9800**

Desk-Front Projection

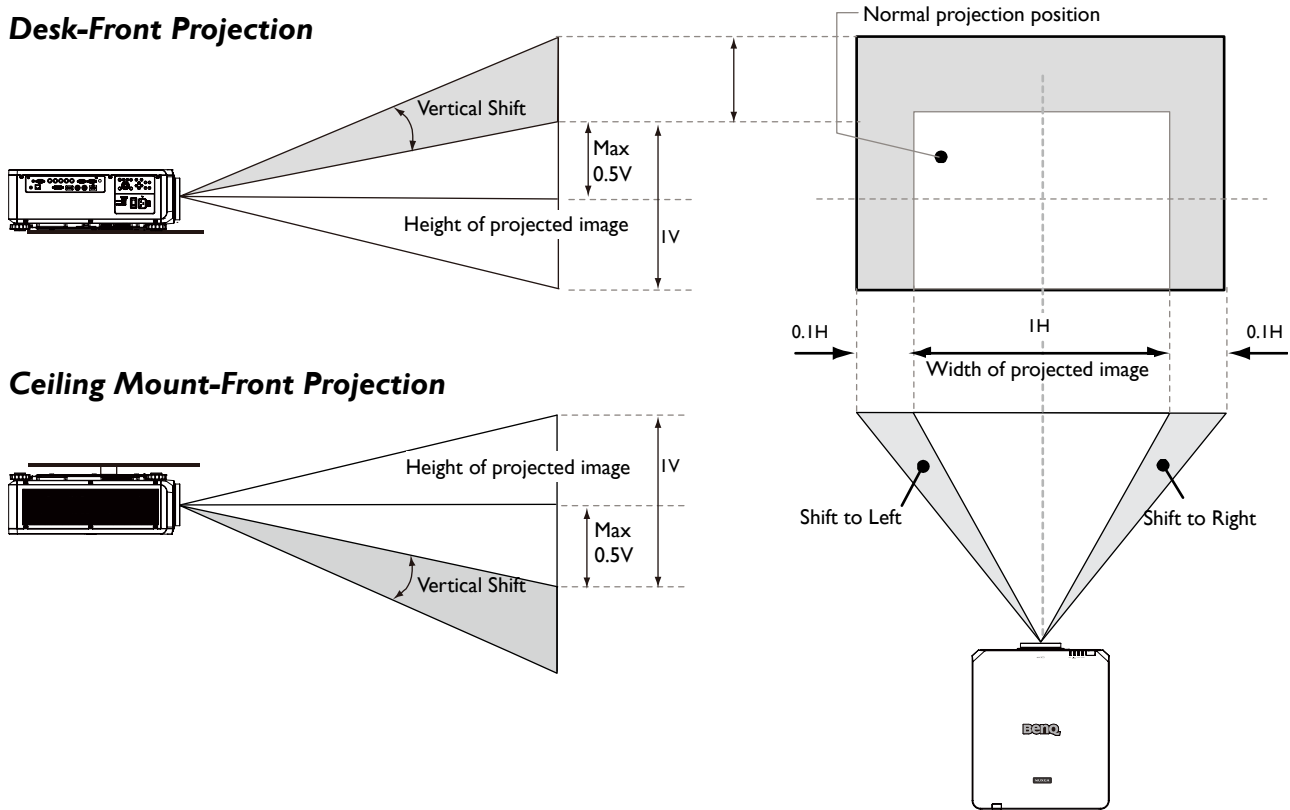

- **Desktop Installation**

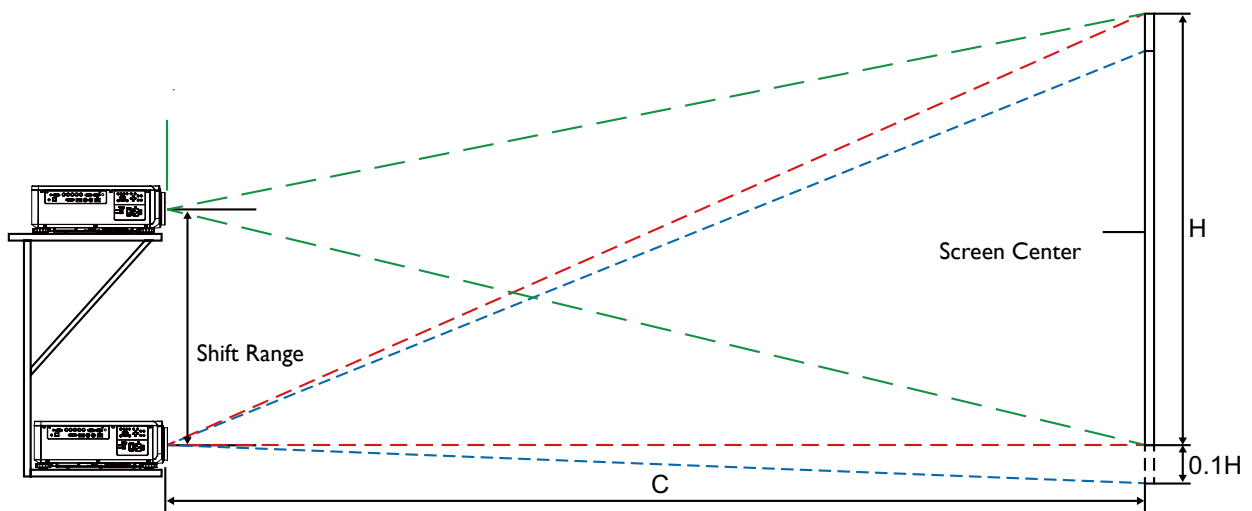

Note:

- The drawings apply to the standard lens only.

LED indicator

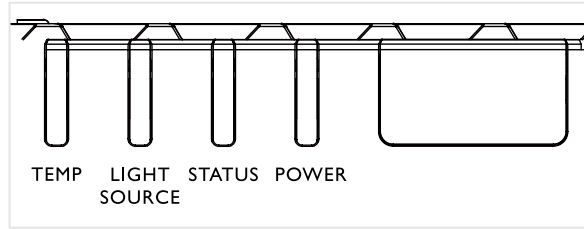

• System message

SYSTEM STATUS	POWER LED	STATUS LED	LIGHT SOURCE LED	TEMP LED
Lamp Ready	ON	OFF	OFF	OFF
Start	Flashing	OFF	OFF	OFF
Cooling	Flashing	OFF	OFF	OFF
Over Temperature T1	OFF	OFF	1 blinks	ON
Over Temperature T2	OFF	OFF	2 blinks	ON
Over Temperature T3	OFF	OFF	3 blinks	ON
Over Temperature T4	OFF	OFF	4 blinks	ON
Over Temperature T5	OFF	OFF	5 blinks	ON
Thermal Break Sensor error	OFF	4 blinks	OFF	OFF
Air Filter Warning	ON	ON	OFF	OFF
FAN1 error	OFF	6 blinks	1 blinks	OFF
FAN2 error	OFF	6 blinks	2 blinks	OFF
FAN3 error	OFF	6 blinks	3 blinks	OFF
FAN4 error	OFF	6 blinks	4 blinks	OFF
FAN5 error	OFF	6 blinks	5 blinks	OFF
FAN6 error	OFF	6 blinks	6 blinks	OFF
FAN7 error	OFF	6 blinks	7 blinks	OFF
FAN8 error	OFF	6 blinks	8 blinks	OFF
FAN9 error	OFF	6 blinks	9 blinks	OFF
FAN10 error	OFF	6 blinks	10 blinks	OFF
FAN11 error	OFF	6 blinks	11 blinks	OFF
FAN12 error	OFF	6 blinks	12 blinks	OFF
FAN13 error	OFF	6 blinks	13 blinks	OFF
IW MCU detects scaler stops working	OFF	2 blinks	OFF	OFF
Case Open	OFF	7 blinks	OFF	OFF
Lens Open	OFF	7 blinks	1 blinks	OFF
DMD error	OFF	8 blinks	OFF	OFF
Color wheel error	OFF	9 blinks	OFF	OFF
Phosphor wheel error	OFF	9 blinks	1 blinks	OFF
Laser Driver board Color wheel speed too low	OFF	4 blinks	2 blinks	OFF
Laser Driver board Phosphor wheel speed too low	OFF	4 blinks	3 blinks	OFF

SYSTEM STATUS	POWER LED	STATUS LED	LIGHT SOURCE LED	TEMP LED
Laser Driver board 54V error	OFF	4 blinks	4 blinks	OFF
Laser Driver board over temp	OFF	4 blinks	5 blinks	OFF
Laser Driver board SCI error	OFF	4 blinks	6 blinks	OFF
Laser Driver board initial fail	OFF	4 blinks	7 blinks	OFF
Laser Driver board lit fail	OFF	4 blinks	8 blinks	OFF

Projector dimension

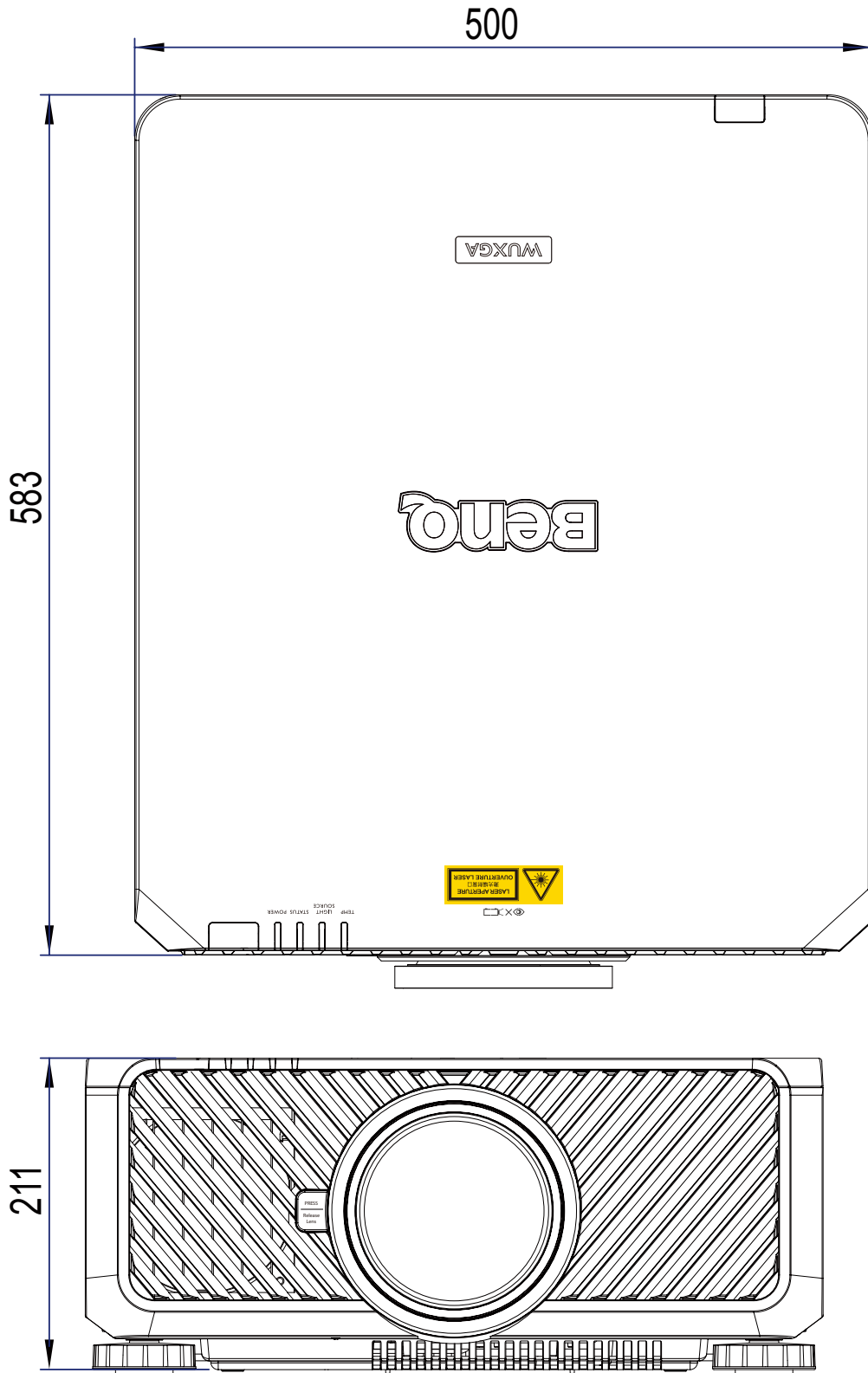

Lens dimension

Optional Lens (Standard: LSISDA)

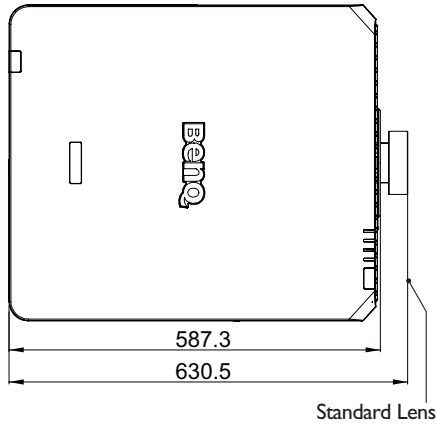

Optional Lens (Semi Long 2: LSILT1)

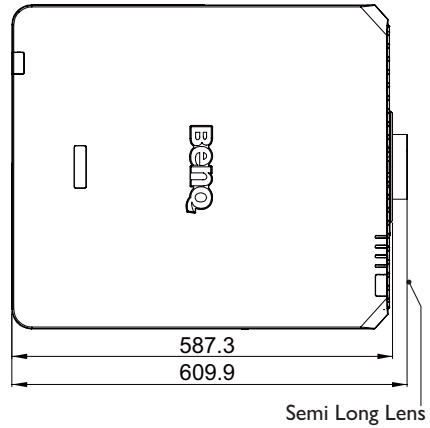

Optional Lens (Short Throw: LSIST3A)

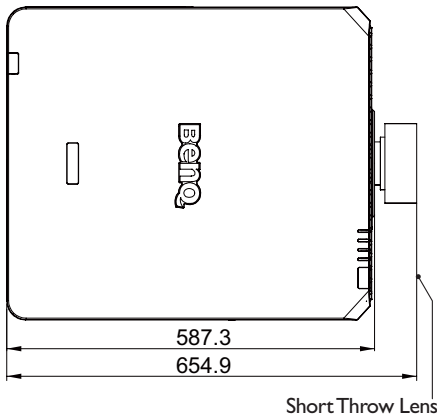

Optional Lens (Long 1: LSILT2)

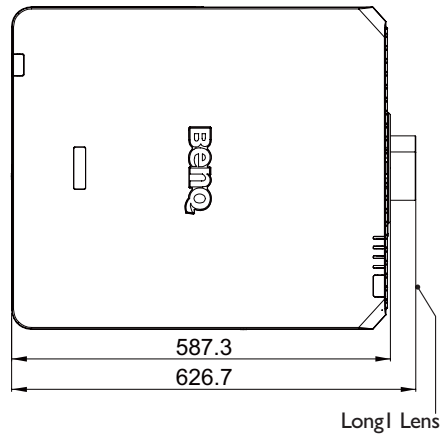

Optional Lens (Wide Zoom 1: LSIST1A)

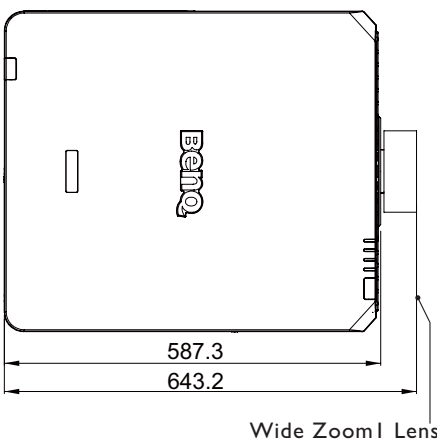

Optional Lens (Long 2: LSILT3)

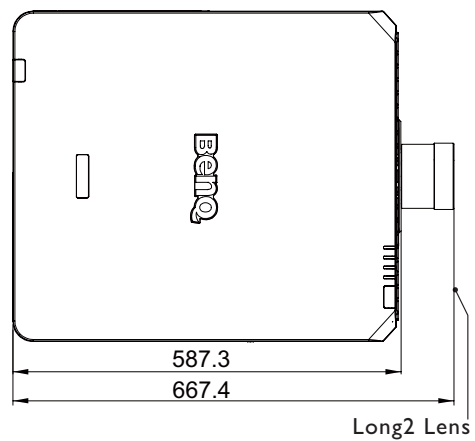

Optional Lens (Semi Long: LSILT0)

Optional Lens (Ultra Short Throw: LSIST4)

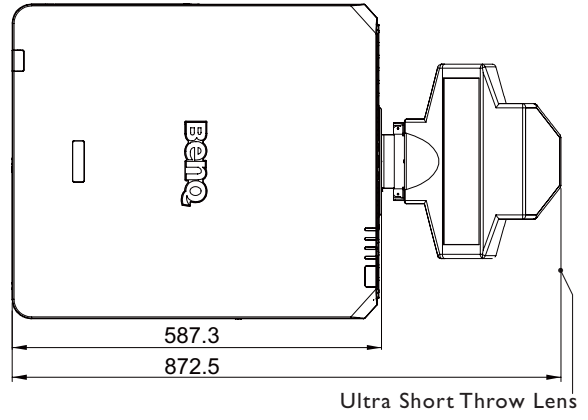
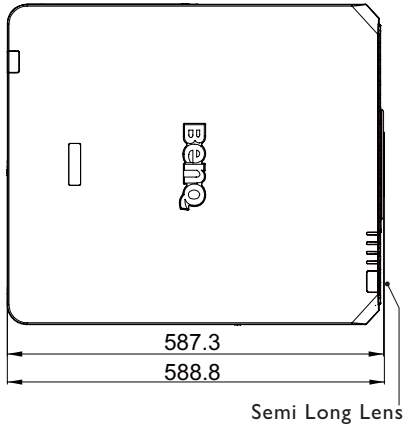

Optional Lens (Wide Zoom 2: LSIST2A)

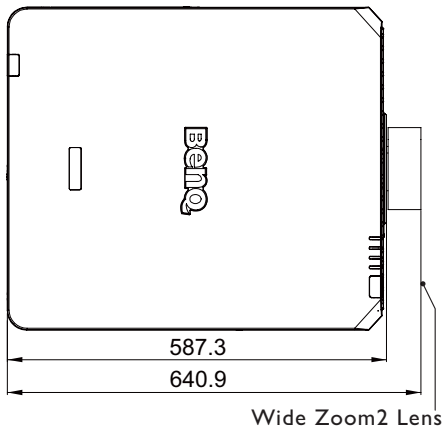

RS232 command control

RS232 pin assignment

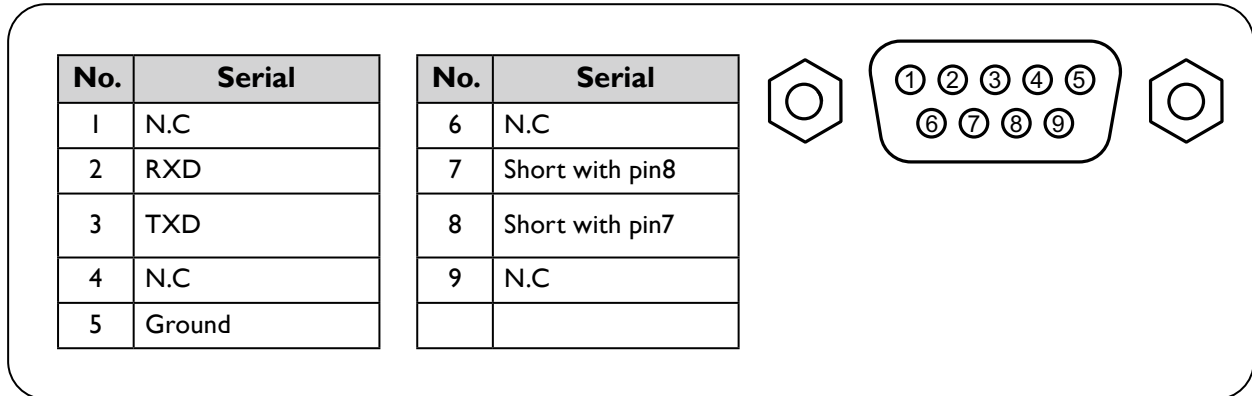

RS232 serial port with a crossover cable

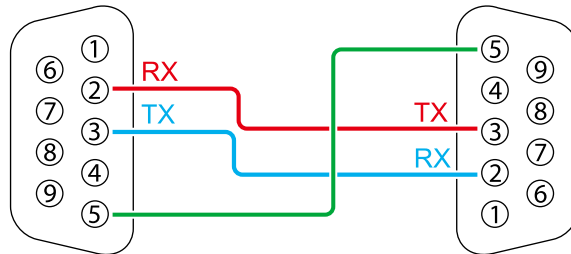

Function	Type	Operation	ASCII
Power	Write	Power On	<CR>*pow=on#<CR>
	Write	Power Off	<CR>*pow=off#<CR>
	Read	Power Status	<CR>*pow=?#<CR>
Source Selection	Write	COMPUTER/YPbPr	<CR>*sour=RGB#<CR>
	Write	COMPUTER 2/YPbPr2	<CR>*sour=RGB2#<CR>
	Write	DVI-D	<CR>*sour=dvid#<CR>
	Write	HDMI(MHL)	<CR>*sour=hdmi#<CR>
	Write	HDMI 2(MHL2)	<CR>*sour=hdmi2#<CR>
	Write	HDBaseT	<CR>*sour=hdbaset#<CR>
	Read	Current source	<CR>*sour=?#<CR>
Audio Control	Write	Mute On	<CR>*mute=on#<CR>
	Write	Mute Off	<CR>*mute=off#<CR>
	Read	Mute Status	<CR>*mute=!#<CR>
	Write	Volume +	<CR>*vol=+#<CR>
	Write	Volume -	<CR>*vol=-#<CR>
	Write	Volume level for customer	<CR>*vol=value#<CR>
	Read	Volume Status	<CR>*vol=?#<CR>

Function	Type	Operation	ASCII
Audio source select	Write	Audio pass Through off	<CR>*audiosour=off#<CR>
	Write	Audio-Computer I	<CR>*audiosour=RGB#<CR>
	Write	Audio-HDMI	<CR>*audiosour=hdmi#<CR>
	Write	Audio-HDMI2	<CR>*audiosour=hdmi2#<CR>
	Write	HDBaseT	<CR>*audiosour=hdbaset#<CR>
	Read	Audio pass Status	<CR>*audiosour=?#<CR>
Picture Mode	Write	Presentation	<CR>*appmod=preset#<CR>
	Write	sRGB	<CR>*appmod=srgb#<CR>
	Write	Bright	<CR>*appmod=bright#<CR>
	Write	DICOM	<CR>*appmod=dicom#<CR>
	Write	Video	<CR>*appmod=video#<CR>
	Write	Infographic	<CR>*appmod=infographic#<CR>
	Write	User1	<CR>*appmod=user1#<CR>
	Write	User2	<CR>*appmod=user2#<CR>
	Write	3D	<CR>*appmod=threed#<CR>
	Write	HDR10	<CR>*appmod=hdr#<CR>
	Write	HLG	<CR>*appmod=hlg#<CR>
	Read	Picture Mode	<CR>*appmod=?#<CR>
	Write	Contrast +	<CR>*con=+#<CR>
	Write	Contrast -	<CR>*con=-#<CR>
Picture Setting	Write	Set Contrast value	<CR>*con=value#<CR>
	Read	Contrast value	<CR>*con=?#<CR>
	Write	Brightness +	<CR>*bri=+#<CR>
	Write	Brightness -	<CR>*bri=-#<CR>
	Write	Set Brightness value	<CR>*bri=value#<CR>
	Read	Brightness value	<CR>*bri=?#<CR>
	Write	Color +	<CR>*color=+#<CR>
	Write	Color -	<CR>*color=-#<CR>
	Write	Set Color value	<CR>*color=value#<CR>
	Read	Color value	<CR>*color=?#<CR>
	Write	Sharpness +	<CR>*sharp=+#<CR>
	Write	Sharpness -	<CR>*sharp=-#<CR>
	Write	Set Sharpness value	<CR>*sharp=value#<CR>
	Read	Sharpness value	<CR>*sharp=?#<CR>
	Write	Color Temperature-Warm	<CR>*ct=warm#<CR>
	Write	Color Temperature-Normal	<CR>*ct=normal#<CR>
	Write	Color Temperature-Cool	<CR>*ct=cool#<CR>
	Read	Color Temperature Status	<CR>*ct=?#<CR>
	Write	Aspect 4:3	<CR>*asp=4:3#<CR>
	Write	Aspect 16:9	<CR>*asp=16:9#<CR>
Write	Aspect 16:10	<CR>*asp=16:10#<CR>	
Write	Aspect 2.35:1	<CR>*asp=2.35#<CR>	

Function	Type	Operation	ASCII
Picture Setting	Write	Aspect Auto	<CR>*asp=AUTO#<CR>
	Write	Aspect Real	<CR>*asp=REAL#<CR>
	Read	Aspect Status	<CR>*asp=?#<CR>
	Write	Vertical Keystone +	<CR>*vkeystone=+#<CR>
	Write	Vertical Keystone -	<CR>*vkeystone=-#<CR>
	Write	Set Vertical Keystone value	<CR>*vkeystone=value#<CR>
	Read	Vertical Keystone value	<CR>*vkeystone=?#<CR>
	Write	Horizontal Keystone +	<CR>*hkeystone=+#<CR>
	Write	Horizontal Keystone -	<CR>*hkeystone=-#<CR>
	Write	Set Horizontal Keystone value	<CR>*hkeystone=value#<CR>
	Read	Horizontal Keystone value	<CR>*hkeystone=?#<CR>
	Write	Overscan Adjustment +	<CR>*overscan=+#<CR>
	Write	Overscan Adjustment -	<CR>*overscan=-#<CR>
	Read	Overscan Adjustment value	<CR>*overscan=?#<CR>
	Write	4 Corners Top-Left-X Decrease	<CR>*cornerfittlx=-#<CR>
	Write	4 Corners Top-Left-X Increase	<CR>*cornerfittlx=+#<CR>
	Read	4 Corners Top-Left-X Status	<CR>*cornerfittlx=?#<CR>
	Write	4 Corners Top-Left-Y Decrease	<CR>*cornerfittly=-#<CR>
	Write	4 Corners Top-Left-Y Increase	<CR>*cornerfittly=+#<CR>
	Read	4 Corners Top-Left-Y Status	<CR>*cornerfittly=?#<CR>
	Write	4 Corners Top-Right-X Decrease	<CR>*cornerfittrx=-#<CR>
	Write	4 Corners Top-Right-X Increase	<CR>*cornerfittrx=+#<CR>
	Read	4 Corners Top-Right-X Status	<CR>*cornerfittrx=?#<CR>
	Write	4 Corners Top-Right-Y Decrease	<CR>*cornerfittry=-#<CR>
	Write	4 Corners Top-Right-Y Increase	<CR>*cornerfittry=+#<CR>
	Read	4 Corners Top-Right-Y Status	<CR>*cornerfittry=?#<CR>
	Write	4 Corners Bottom-Left-X Decrease	<CR>*cornerfitblx=-#<CR>
	Write	4 Corners Bottom-Left-X Increase	<CR>*cornerfitblx=+#<CR>
	Read	4 Corners Bottom-Left-X Status	<CR>*cornerfitblx=?#<CR>
	Write	4 Corners Bottom-Left-Y Decrease	<CR>*cornerfitbly=-#<CR>
	Write	4 Corners Bottom-Left-Y Increase	<CR>*cornerfitbly=+#<CR>
	Read	4 Corners Bottom-Left-Y Status	<CR>*cornerfitbly=?#<CR>
	Write	4 Corners Bottom-Right-X Decrease	<CR>*cornerfitbrx=-#<CR>
	Write	4 Corners Bottom-Right-X Increase	<CR>*cornerfitbrx=+#<CR>
	Read	4 Corners Bottom-Right-X Status	<CR>*cornerfitbrx=?#<CR>
	Write	4 Corners Bottom-Right-Y Decrease	<CR>*cornerfitbry=-#<CR>
	Write	4 Corners Bottom-Right-Y Increase	<CR>*cornerfitbry=+#<CR>
	Read	4 Corners Bottom-Right-Y Status	<CR>*cornerfitbry=?#<CR>
	Write	Digital Zoom In	<CR>*zoomI#<CR>
	Write	Digital Zoom out	<CR>*zoomO#<CR>
	Write	Auto	<CR>*auto#<CR>
	Write	Brilliant color +	<CR>*BC=+#<CR>

Function	Type	Operation	ASCII
Picture Setting	Write	Brilliant color -	<CR>*BC=-#<CR>
	Write	Brilliant color set value	<CR>*BC=value#<CR>
	Read	Brilliant color status	<CR>*BC=?#<CR>
	Write	Auto(HDR)	<CR>*hdr=auto#<CR>
	Write	SDR	<CR>*hdr=sdr#<CR>
	Write	HDR10	<CR>*hdr=hdr#<CR>
	Write	HLG	<CR>*hdr=hlg#<CR>
	Read	HDR status	<CR>*hdr=?#<CR>
	Write	Reset current picture settings	<CR>*rstcurpicsetting#<CR>
	Write	Reset all picture settings	<CR>*rstallpicsetting#<CR>
Operation Settings	Write	Projector Position-Front Table	<CR>*pp=FT#<CR>
	Write	Projector Position-Rear Table	<CR>*pp=RE#<CR>
	Write	Projector Position-Rear Ceiling	<CR>*pp=RC#<CR>
	Write	Projector Position-Front Ceiling	<CR>*pp=FC#<CR>
	Read	Projector Position Status	<CR>*pp=?#<CR>
	Write	Quick auto search	<CR>*QAS=on#<CR>
	Write	Quick auto search	<CR>*QAS=off#<CR>
	Read	Quick auto search status	<CR>*QAS=?#<CR>
	Write	Menu Position - Center	<CR>*menuposition=center#<CR>
	Write	Menu Position - Top-Left	<CR>*menuposition=tl#<CR>
	Write	Menu Position - Top-Right	<CR>*menuposition=tr#<CR>
	Write	Menu Position - Bottom-Right	<CR>*menuposition=br#<CR>
	Write	Menu Position - Bottom-Left	<CR>*menuposition=bl#<CR>
	Read	Menu Position Status	<CR>*menuposition=?#<CR>
	Write	Direct Power On-on	<CR>*directpower=on#<CR>
	Write	Direct Power On-off	<CR>*directpower=off#<CR>
	Read	Direct Power On-Status	<CR>*directpower=?#<CR>
	Write	Signal Power On-on	<CR>*autopower=on#<CR>
Write	Signal Power On-off	<CR>*autopower=off#<CR>	
Read	Signal Power On-Status	<CR>*autopower=?#<CR>	
Baud Rate	Write	2400	<CR>*baud=2400#<CR>
	Write	4800	<CR>*baud=4800#<CR>
	Write	9600	<CR>*baud=9600#<CR>
	Write	14400	<CR>*baud=14400#<CR>
	Write	19200	<CR>*baud=19200#<CR>
	Write	38400	<CR>*baud=38400#<CR>
	Write	57600	<CR>*baud=57600#<CR>
	Write	115200	<CR>*baud=115200#<CR>
	Read	Current Baud Rate	<CR>*baud=?#<CR>

Function	Type	Operation	ASCII
Lamp Control	Read	Lamp Hour	<CR>*ltim=?#<CR>
	Write	Normal mode	<CR>*lampm=lnor#<CR>
	Write	Eco mode	<CR>*lampm=eco#<CR>
	Write	Dimming mode	<CR>*lampm=dimming#<CR>
	Write	Custom mode	<CR>*lampm=custom#<CR>
	Write	Light level for custom mode	<CR>*lampcustom=value#<CR>
	Read	Light level status for custom mode	<CR>*lampcustom=?#<CR>
	Read	Lamp Mode Status	<CR>*lampm=?#<CR>
Miscellaneous	Read	Model Name	<CR>*modelname=?#<CR>
	Read	System F/W Version	<CR>*sysfwversion=?#<CR>
	Read	Scaler F/W Version	<CR>*scalerfwversion=?#<CR>
	Read	Lan F/W Version	<CR>*lanfwversion=?#<CR>
	Read	MCU F/W Version	<CR>*mcfwversion=?#<CR>
	Write	Blank On	<CR>*blank=on#<CR>
	Write	Blank Off	<CR>*blank=off#<CR>
	Read	Blank Status	<CR>*blank=?#<CR>
	Write	Freeze On	<CR>*freeze=on#<CR>
	Write	Freeze Off	<CR>*freeze=off#<CR>
	Read	Freeze Status	<CR>*freeze=?#<CR>
	Write	Menu On	<CR>*menu=on#<CR>
	Write	Menu Off	<CR>*menu=off#<CR>
	Read	Menu Status	<CR>*menu=?#<CR>
	Write	Up	<CR>*up#<CR>
	Write	Down	<CR>*down#<CR>
	Write	Right	<CR>*right#<CR>
	Write	Left	<CR>*left#<CR>
	Write	Enter	<CR>*enter#<CR>
	Write	Back	<CR>*back#<CR>
	Write	Source Menu On	<CR>*sourmenu=on#<CR>
	Write	Source Menu Off	<CR>*sourmenu=off#<CR>
	Read	Source Menu Status	<CR>*sourmenu=?#<CR>
	Write	3D Sync Off	<CR>*3d=off#<CR>
	Write	3D Auto	<CR>*3d=auto#<CR>
	Write	3D Sync Top Bottom	<CR>*3d=tb#<CR>
	Write	3D Sync Frame Sequential	<CR>*3d=fs#<CR>
	Write	3D Frame packing	<CR>*3d=fp#<CR>
	Write	3D Side by side	<CR>*3d=sbs#<CR>
	Write	3D inverter disable	<CR>*3d=da#<CR>
	Write	3D inverter	<CR>*3d=iv#<CR>
	Write	3D nVIDIA	<CR>*3d=nvidia#<CR>
Read	3D Sync Status	<CR>*3d=?#<CR>	
Write	Remote Receiver-front+rear	<CR>*rr=fr#<CR>	

Function	Type	Operation	ASCII
Miscellaneous	Write	Remote Receiver-front	<CR>*rr=f#<CR>
	Write	Remote Receiver-rear	<CR>*rr=r#<CR>
	Read	Remote Receiver Status	<CR>*rr=?#<CR>
	Write	AMX Device Discovery-on	<CR>*amxdd=on#<CR>
	Write	AMX Device Discovery-off	<CR>*amxdd=off#<CR>
	Read	AMX Device Discovery Status	<CR>*amxdd=?#<CR>
	Read	Mac Address	<CR>*macaddr=?#<CR>
	Read	Serial Number	<CR>*serialnumber=?#<CR>
	Write	High Altitude mode on	<CR>*Highaltitude=on#<CR>
	Write	High Altitude mode off	<CR>*Highaltitude=off#<CR>
	Read	High Altitude mode status	<CR>*Highaltitude=?#<CR>
Installation	Write	Load Lens memory 1	<CR>*lensload=m1#<CR>
	Write	Load Lens memory 2	<CR>*lensload=m2#<CR>
	Write	Load Lens memory 3	<CR>*lensload=m3#<CR>
	Write	Load Lens memory 4	<CR>*lensload=m4#<CR>
	Write	Load Lens memory 5	<CR>*lensload=m5#<CR>
	Write	Load Lens memory 6	<CR>*lensload=m6#<CR>
	Write	Load Lens memory 7	<CR>*lensload=m7#<CR>
	Write	Load Lens memory 8	<CR>*lensload=m8#<CR>
	Write	Load Lens memory 9	<CR>*lensload=m9#<CR>
	Write	Load Lens memory 10	<CR>*lensload=m10#<CR>
	Read	Read Lens memory status	<CR>*lensload=?#<CR>
	Write	save Lens memory 1	<CR>*lenssave=m1#<CR>
	Write	save Lens memory 2	<CR>*lenssave=m2#<CR>
	Write	save Lens memory 3	<CR>*lenssave=m3#<CR>
	Write	save Lens memory 4	<CR>*lenssave=m4#<CR>
	Write	save Lens memory 5	<CR>*lenssave=m5#<CR>
	Write	save Lens memory 6	<CR>*lenssave=m6#<CR>
	Write	save Lens memory 7	<CR>*lenssave=m7#<CR>
	Write	save Lens memory 8	<CR>*lenssave=m8#<CR>
	Write	save Lens memory 9	<CR>*lenssave=m9#<CR>
	Write	save Lens memory 10	<CR>*lenssave=m10#<CR>
Write	Reset Lens to center	<CR>*lensreset=center#<CR>	
Color Calibration	Write	Tint +	<CR>*tint=+#<CR>
	Write	Tint -	<CR>*tint=-#<CR>
	Write	Set Tint value	<CR>*tint=value#<CR>
	Read	Get Tint value	<CR>*tint=?#<CR>
	Write	Set gamma value	<CR>*gamma=value#<CR>
	Read	Gamma value status	<CR>*gamma=?#<CR>
	Write	Set HDR Brightness value	<CR>*hdrbri=value#<CR>
	Read	Get HDR Brightness value	<CR>*hdrbri=?#<CR>
	Write	Red Gain +	<CR>*RGain=+#<CR>

Function	Type	Operation	ASCII
Color Calibration	Write	Red Gain -	<CR>*RGain=-#<CR>
	Write	Set Red Gain value	<CR>*RGain=value#<CR>
	Read	Get Red Gain value	<CR>*RGain=?#<CR>
	Write	Green Gain +	<CR>*GGain=+#<CR>
	Write	Green Gain -	<CR>*GGain=-#<CR>
	Write	Set Green Gain value	<CR>*GGain=value#<CR>
	Read	Get Green Gain value	<CR>*GGain=?#<CR>
	Write	Blue Gain +	<CR>*BGain=+#<CR>
	Write	Blue Gain -	<CR>*BGain=-#<CR>
	Write	Set Blue Gain value	<CR>*BGain=value#<CR>
	Read	Get Blue Gain value	<CR>*BGain=?#<CR>
	Write	Red Offset +	<CR>*ROffset=+#<CR>
	Write	Red Offset -	<CR>*ROffset=-#<CR>
	Write	Set Red Offset value	<CR>*ROffset=value#<CR>
	Read	Get Red Offset value	<CR>*ROffset=?#<CR>
	Write	Green Offset +	<CR>*GOffset=+#<CR>
	Write	Green Offset -	<CR>*GOffset=-#<CR>
	Write	Set Green Offset value	<CR>*GOffset=value#<CR>
	Read	Get Green Offset value	<CR>*GOffset=?#<CR>
	Write	Blue Offset +	<CR>*BOffset=+#<CR>
	Write	Blue Offset -	<CR>*BOffset=-#<CR>
	Write	Set Blue Offset value	<CR>*BOffset=value#<CR>
	Read	Get Blue Offset value	<CR>*BOffset=?#<CR>
	Write	Primary Color	<CR>*primcr=value#<CR>
	Read	Primary Color Status	<CR>*primcr=?#<CR>
	Write	Hue +	<CR>*hue=+#<CR>
	Write	Hue -	<CR>*hue=-#<CR>
	Write	Set Hue value	<CR>*hue=value#<CR>
	Read	Get Hue value	<CR>*hue=?#<CR>
	Write	Saturation +	<CR>*saturation=+#<CR>
	Write	Saturation -	<CR>*saturation=-#<CR>
	Write	Set Saturation value	<CR>*saturation=value#<CR>
Read	Get Saturation value	<CR>*saturation=?#<CR>	
Write	Gain +	<CR>*gain=+#<CR>	
Write	Gain -	<CR>*gain=-#<CR>	
Write	Set Gain value	<CR>*gain=value#<CR>	
Read	Get Gain value	<CR>*gain=?#<CR>	

Function	Type	Operation	ASCII
Service	Read	Error Code report	<CR>*error=report#<CR>
	Read	FAN 1 speed	<CR>*fan1=?#<CR>
	Read	FAN 2 speed	<CR>*fan2=?#<CR>
	Read	FAN 3 speed	<CR>*fan3=?#<CR>
	Read	FAN 4 speed	<CR>*fan4=?#<CR>
	Read	FAN 5 speed	<CR>*fan5=?#<CR>
	Read	FAN 6 speed	<CR>*fan6=?#<CR>
	Read	FAN 7 speed	<CR>*fan7=?#<CR>
	Read	FAN 8 speed	<CR>*fan8=?#<CR>
	Read	FAN 9 speed	<CR>*fan9=?#<CR>
	Read	FAN 10 speed	<CR>*fan10=?#<CR>
	Read	FAN 11 speed	<CR>*fan11=?#<CR>
	Read	FAN 12 speed	<CR>*fan12=?#<CR>
	Read	FAN 13 speed	<CR>*fan13=?#<CR>
	Read	Temperature 1	<CR>*tmp1=?#<CR>
	Read	Temperature 2	<CR>*tmp2=?#<CR>
	Read	Temperature 3	<CR>*tmp3=?#<CR>
	Read	Temperature 4	<CR>*tmp4=?#<CR>
Read	Temperature 5	<CR>*tmp5=?#<CR>	
Read	LED indicator	<CR>*led=?#<CR>	

PJLink

• PJLink protocol

The network function of this projector support the PJLink class I, and the PJLink protocol can be used to perform projector setting and projector status query operations from a computer.

• Control commands

The following table lists the PJLink protocol commands that can be used to control the projector.

- x characters in table are non-specific characters.

Command	Control Details	Parameter/ Return String	Remark		
POWR	Power supply control	0 1	Standby Power on		
POWR?	Power supply status query	0 1	Standby Power on		
INPT	Input selection	11	PCI / YPbPr1		
INPT?	Input status query	12	PC2 / YPbPr2		
		21	VIDEO		
		31	HDMI1		
		32	HDMI2		
		33	DVI-D		
		34	HDBaseT		
AVMT	Mute	11	Video mute On		
AVMT?	Mute query	10	Video mute Off		
		21	Audio mute On		
		20	Audio mute Off		
		31	Video & Audio mute On		
		30	Video & Audio mute Off		
ERST?	Error status query	xxxxxx	1st byte	Indicates fan errors, and returns 0 - 2	0 = No error is detected 1 = Warning 2 = Error
			2nd byte	Indicates light source errors, and returns 0 - 2	
			3rd byte	Indicates temperature errors, and returns 0 - 2	
			4th byte	Return 0	
			5th byte	Return 0	
			6th byte	Indicates other errors, and returns 0 - 2	
LAMP?	Light source status query	xxxxxxxxxxxx	1st number (1-5 digitals): Light source 1 runtime		
INST?	Input selection list query	11 12 21 31 32 33 34	LU9750/LU9800		
NAME?	Projector name query	xxxxx	Returns the name set in [PROJECTOR NAME] of [NETWORK SETUP]		

Command	Control Details	Parameter/ Return String	Remark
INFI?	Manufacturer name query	BenQ	Returns manufacturer name
INF2?	Model name query	LU9750/LU9800	Returns model name
INF0?	Other information queries	xxxxx	Returns information such as version number
CLASS?	Class information query	I	Returns class for PJLink

 **Note:**

RS-232 baud rate options are 2400, 4800, 9600, 14400, 19200, 38400, 57600 and 115200 (Default : 115200).



ecoFACTS
csr.BenQ.com

- Arsenic-free optical glass
- BFR/PVC-free casing plastics
- PVC-free plastic packaging
- Verre optique exempt d'arsenic
- Boîtier de plastique exempt de BFR/PVC
- Emballage de plastique exempt de PVC

HDMI™
HIGH-DEFINITION MULTIMEDIA INTERFACE



BenQ.com

© 2019 BenQ Corporation.
All rights reserved. Rights of modification reserved.
P/N: 4J.JPN01.001