

# ILD500 HANDBOOK

## Handbook Contents

- Safety
- Introduction
- Quick Start
- Overview
- Installation
- Troubleshooting
- Accessories
- Technical Specification
- Warranty
- Declaration of Conformity

## Box Contents

- 1 x ILD500
- 1 x Loop connector
- 1 x Installation & Commissioning Handbook
- 1 x Designing Induction Loops Handbook
- 2 x 1U Rack mounting ears



**This symbol is used to alert the user to important operating or maintenance instructions.**



**The Lightning bolt triangle is used to alert the user to the risk of electric shock.**

## SAFETY

1. It is important to read these instructions, and to follow them.
2. Keep this instruction manual in an accessible place.
3. Clean only with a dry cloth. Cleaning fluids may effect the equipment.
4. Do not block any ventilation openings. Install in accordance with the manufacturer's instructions.
5. Do not install near any heat sources such as radiators, heating vents, or other apparatus that produces heat.
6. **WARNING - THIS APPARATUS MUST BE EARTHED / GROUNDED.**
7. Only power cords with the correct power connector may be used to maintain safety. Cables incorporating the UK 13A fused plug, Schuko with earthing contacts and UL approved "grounding type" are acceptable. These must be plugged into power outlets which provide a protective earth.
8. Refer all servicing to qualified personnel. Servicing is required when the apparatus has been damaged in any way, such as a power supply cord or plug is damaged, liquid has been spilled or objects have fallen into the apparatus, the apparatus has been exposed to any rain or moisture, does not operate normally or has been dropped.
9. **WARNING - To reduce risk of fire or electric shock, do not expose this apparatus to rain or moisture. The apparatus shall not be exposed to dripping or splashing and no objects filled with liquids, such as vases, shall be placed on the apparatus.**



**CAUTION**  
RISK OF ELECTRIC SHOCK  
DO NOT OPEN

**TO PREVENT ELECTRIC SHOCK DO NOT REMOVE THE COVER. THERE ARE NO USER SERVICEABLE PARTS INSIDE. REFER SERVICING TO QUALIFIED PERSONNEL.**

## INTRODUCTION

The ILD500 Induction Loop Driver has been designed as a high quality amplifier for use with conference rooms, stadia, theatres, sports halls, confidential rooms, lecture halls and cinemas. Depending on a number of factors regarding the installation of the loop and set-up of the amplifier, the ILD500 can provide compliance with IEC60118-4 for areas > 700m<sup>2</sup>.

Ease of installation and use have been major factors in the design, combined with optimised performance, and freedom from R.F.I. Generation.

The ILD500 has two inputs which allow connection to a standard line level signal and a balanced microphone.

For more complex installations, you may need additional ancillary equipment such as microphone pre-amplifier(s), adaptor(s) for use with 100V Line, or signal processing units. See **Accessories**, or contact Ampetronic for advice.

## QUICK START

For those who have a good appreciation of loop systems, the following is a very quick guide to setting up the amplifier:

All you need is a power source, a signal source and a loop. See 'Designing Induction Loops' handbook (supplied) or contact Ampetronic for advice.

### Installation

1. Turn all controls fully anti-clockwise.
2. Connect loop cable of appropriate length / gauge.
3. Connect signal input(s).
4. Connect power. See points 6 and 7 in **Safety** Section.

### Operation

5. Switch ON - Check green POWER LED flashes during self test and illuminates continuously when checks are completed.
6. Apply input signal, and increase the input control until two green COMPRESSION LEDs begin to light on the peaks of the signal.
7. Adjust the LOOP CURRENT control until the CURRENT LEDs illuminate to achieve the desired peak current.
8. Repeat step 6 for the other input if used.
9. Listen to the magnetic field produced inside the loop area using a receiving device (e.g Ampetronic ILR3), or examine the performance in more detail with a field strength meter.
10. Adjust METAL LOSS CORRECTION to achieve a flat frequency response.

# OVERVIEW

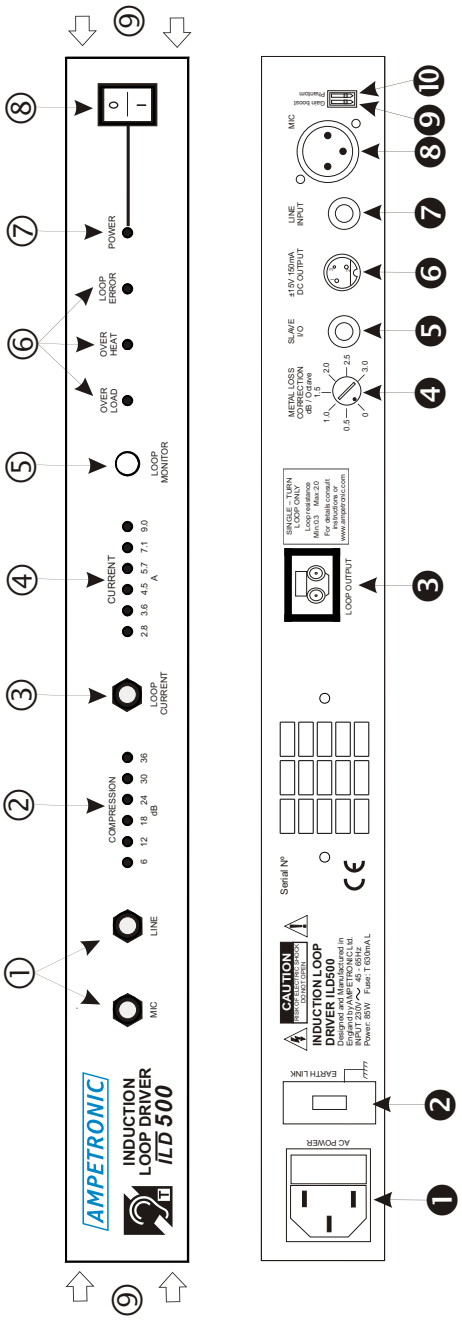

- ① **MIC and LINE:** Screwdriver adjustable controls which set the level of signal fed into the compressor from Mic and Line inputs.
- ② **COMPRESSION:** Shows the amount of gain reduction in decibels that is applied to the input signal(s).
- ③ **LOOP CURRENT:** Screwdriver adjustable control which sets the level of output current delivered into the loop.
- ④ **CURRENT:** Indicates the peak current delivered into the loop.
- ⑤ **LOOP MONITOR:** 3.5mm jack socket for use with stereo headphones to listen directly to the signal in the loop.
- ⑥ **OVERLOAD, OVERHEAT, LOOP ERROR:** Warning LEDs, see Troubleshooting section for explanation and advise.
- ⑦ **POWER:** LED to indicate AC power is applied to the unit.
- ⑧ **I / O:** Power switch.
- ⑨ Rack ear fixing screws - A TX10 screwdriver is required.

- ① **AC POWER:** Standard 3-pole IEC320 connector containing primary fuse for the unit.
- ② **EARTH LINK:** Slide switch to disconnect the audio circuits from AC power ground.
- ③ **LOOP OUTPUT:** 2-pole high current connection to the loop cable.
- ④ **METAL LOSS CORRECTION:** Screwdriver adjustable control which compensates for the frequency dependent effects of metal.
- ⑤ **SLAVE I/O:** Post compressor signal for use with ancillaries.
- ⑥ **±15V 150mA DC OUTPUT:** 3-pin power Mini DIN
- ⑦ **LINE INPUT:** 6.4mm Jack socket for balanced line level signals.
- ⑧ **MIC INPUT:** XLR socket for use with balanced microphones.
- ⑨ **GAIN BOOST:** Increases gain of MIC input by 15dB.
- ⑩ **PHANTOM:** Applies +15V<sub>DC</sub> phantom power to MIC input.

## Connections

### LINE INPUT

Balanced

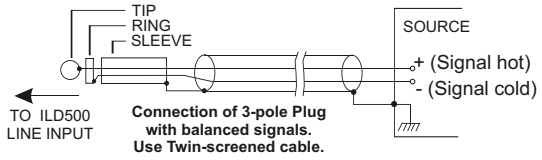

Unbalanced

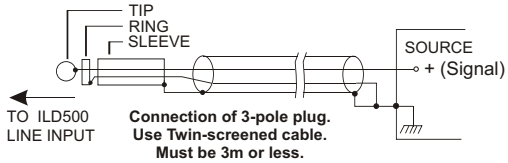

### MIC INPUT

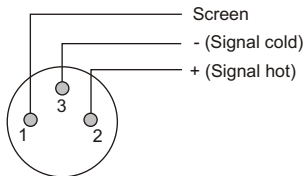

Connection of balanced male XLR for microphone input

### SLAVE I/O

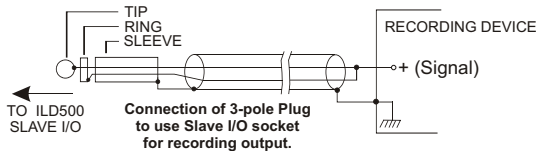

### LOOP CONNECTOR

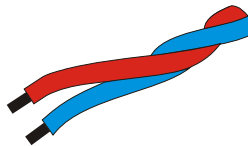
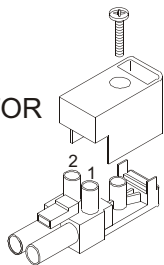

Twisted feeder cable to loop

Undo the screw to remove the cover. Strip 5mm of insulation from the feeder wires and insert into loop connector. Tighten the retaining screws and replace the cover.

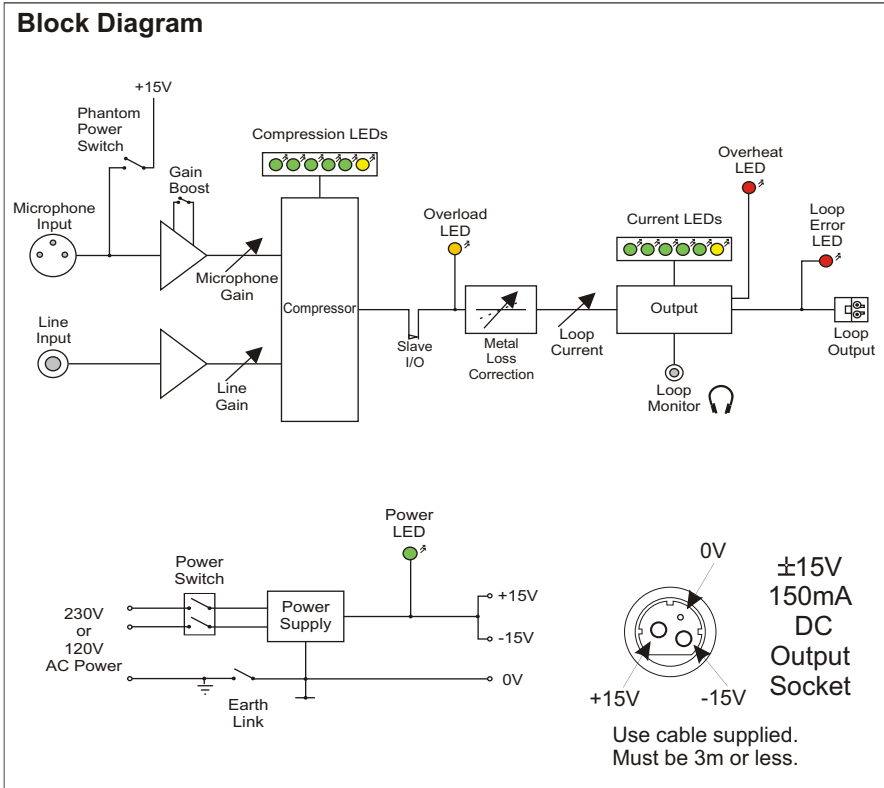

## INSTALLATION

### Location:

The unit may be free standing or 19" rack mountable using the pair of rack ears supplied. The screws which fix the rack ears to the unit are located at the front of each side panel, as shown (↓) in the **Overview**. A TX10 screwdriver will be required to remove & replace the 2 pairs of screws when fixing the rack ears in place. Remove four rubber feet.



The location must provide satisfactory ventilation for the equipment.

An internal fan provides forced ventilation using the air vents at the left side (intake) and rear panel (exhaust) of the unit. Both of these vents must be unobstructed for satisfactory cooling. If the unit is installed in an enclosed environment, sufficient air flow into the enclosure must be provided through vents, fans or other means, such that the units exhaust air is not recycled to the inlet - causing it to OVERHEAT.

## Tools & Equipment:

Small hand tools including a wire stripper and a small flat bladed screwdriver. An ILR3 loop receiver or a magnetic field strength meter is vital to check that the loop system is providing the desired level of performance.

A pair of stereo headphones with a 3.5mm jack plug connection is also useful to monitor the loop signal.

## System Requirements:

The induction loop cable itself should be already installed according to the “Designing Induction loops” handbook, or as per specific design instructions provided by Ampetronic. As a result, a target peak current should be known, based on achieving acceptable field strength across the area to be covered.

## Connection & Set-up:

It is advised that the loop system is initially set up using a local audio source such as CD player, which is not connected into any other system. This avoids the complication of ground loops & feedback etc, whilst the unit is set up.

The following procedure describes the installation of a stand alone ILD500, and does not incorporate connection of other ancillary units such as microphone pre-amps or signal processing units.

1. Turn all controls fully anti-clockwise.
2. Connect the loop cable into the Loop connector supplied. Where using a perimeter loop (floor/ceiling level), the feed cable should be tightly twisted and less than 20m in length. Total resistance of loop and feed must be between 0.3 and 2.0 at DC). The “Designing Induction Loops” handbook contains more details on loop and feed cables. The correct design and positioning of the actual loop is vital for satisfactory system performance. If in doubt consult Ampetronic for advice.
3. Connect the signal input(s) appropriately:
  - a) Suitable dynamic or condenser microphone with balanced cable feed. Select phantom power as required, depending on the type of microphone you are using. Connect to MIC input using a 3-pole XLR plug wired as per **Connections** drawing.
  - b) Line level input from other audio equipment such as PA system, mixing desk or CD player to the LINE INPUT.

You may use either or both inputs.



Do not run the input and output cables close together.

The SLAVE I/O must **NEVER** be used as a separate input. It must only be used with Ampetronic signal processing equipment, or for obtaining a signal for recording. See **Connections** section for details.

4. Connect AC power to the ILD500. See points 6 and 7 in **Safety** section.

5. Switch ON. The POWER LED will flash for a few seconds while an internal self test is performed and the loop resistance is tested. If both tests are successful, the POWER LED will illuminate continuously and the unit will be in an operational mode. If the POWER LED continues to flash, or the 'Loop Error' LED illuminates, consult the **Troubleshooting** section.

6. Select one input and apply a suitable, audio signal (ideally a CD player with music or continuous speech applied to the LINE INPUT, with no connection to the MIC input). Turn the associated input control clockwise until 2 COMPRESSION LEDs are illuminated on the peaks of the signal.

7. Turn the LOOP CURRENT control clockwise until the target current is achieved – as indicated by the CURRENT LEDs. Note that consecutive LEDs illuminate at 2dB intervals. Headphones can be used with the LOOP MONITOR socket to listen directly to the loop current. If high frequency oscillation or low frequency hum is experienced, consult the **Troubleshooting** section.

8. The loop system should now be providing a magnetic field inside the area of the loop – use the ILR3 or field strength meter to examine its performance with respect to:

a) Magnetic field strength. This will vary across the coverage area, due to layout, metal loss and LOOP CURRENT.

b) Frequency response. Metal losses tend to increase with frequency, and may require the adjustment of the METAL LOSS CORRECTION.

As a result of this analysis, adjust the LOOP CURRENT & set the METAL LOSS CORRECTION (on the rear of the unit) to achieve best sound quality. This should result in an adequate magnetic field strength & level frequency response in order to satisfy IEC 60118-4. Note: Do **not** adjust the METAL LOSS CORRECTION whilst listening to the LOOP MONITOR socket.

Once the LOOP CURRENT & METAL LOSS CORRECTION have been adjusted to the correct level they should **not** need re-adjusting.

9. If not already done so, steps can now be taken to integrate the ILD500 into a PA/ mixer arrangement following standard audio techniques. If any unusual effects are experienced refer to the troubleshooting section.

Note: Ideally, each input signal level should be set up to achieve 6dB (one LED) of COMPRESSION with the quietest level of input that is likely to be used. This will maximise the dynamic range of the system and ensure satisfactory performance.

10. Repeat above procedure for other signal input if used. When adjusting each input, make sure that the signal(s) are removed from the other inputs. This ensures that all signals are set to equivalent loudness and drive the compressor properly.

## **TROUBLESHOOTING**

### **POWER LED not illuminated:**

Check that the power (O / I) switch is toggled to the ON (I) position.

A 20mm fuse is incorporated in the AC POWER socket. It is necessary to remove the power cord before extracting the fuse holder. Test the continuity of the fuse using a multimeter. A spare fuse is provided in the fuse holder.



Any replacement fuse **must** be of the same fuse rating and type as printed on the rear panel of the unit.

### **POWER LED flashing continuously:**

Amplifier has failed self test and is in safe mode. No signal will be fed into the loop. Switch the unit OFF, remove all connections except the loop and power connections, turn all front panel controls to minimum and switch back ON. If the problem persists, contact Ampetronic for advice.

### **COMPRESSION LEDs not illuminating:**

Check input connections.

Ensure that the appropriate front panel control (Mic / Line) is turned up.

Check that there is sufficient signal level for the required input.

### **CURRENT LEDs not illuminating:**

Check that the COMPRESSION LEDs are illuminating.

Check that the LOOP CURRENT control is turned up sufficiently.

Check that the LOOP ERROR, or OVERHEAT LEDs are not illuminated.

Ensure the POWER LED is illuminated and not flashing.

Remove any connection to the SLAVE I/O socket.

Check that the loop cable is connected, terminated correctly & inserted into the LOOP OUTPUT socket.

Check the loop cable is not open circuit, short circuit, or connected to earth (see Instability or high frequency noise section of Troubleshooting).

Note: You can listen to the actual loop signal by using a pair of headphones plugged into the loop monitor socket.

### **OVERLOAD LED illuminated:**

Indicates that too much current is being delivered into the loop.

Check that the COMPRESSION LEDs are illuminating.

Remove any connection to the SLAVE I/O socket.

Turn the LOOP CURRENT control down to avoid running too much current into the loop.



Check the loop cable is not open circuit, short circuit, or connected to earth (see Instability or high frequency noise section of **Troubleshooting**).

**OVERHEAT LED illuminated:**

Indicates that the internal heatsink is too hot. Loop current is not delivered.

Ensure that the unit is installed in a location with sufficient ventilation.

Check that nothing is blocking the free flow of air through the vents at the side & the back of the unit.

Check the loop cable is not open circuit, short circuit, or connected to earth (see Instability or high frequency noise section of Troubleshooting).

**LOOP ERROR LED illuminated:**

Indicates that the loop cable connected to the unit is outside specification.

Check that the loop cable is connected, terminated correctly and inserted into the LOOP OUTPUT socket. Ensure the DC resistance is acceptable.

**Low magnetic field strength:**

Due to insufficient LOOP CURRENT or excessive metal loss.

May require a special loop design to achieve acceptable performance, contact Ampetronic for advice.

**Instability or high frequency noise**

1) It is possible for the loop cable to become grounded under fault conditions, resulting in instability which may sound like high frequency noise, buzz or whistling. The results of this type of fault are unpredictable and may appear as any combination of the front panel indication errors.

This fault is easy to determine: simply unplug the loop cable from the amplifier and test with a resistance meter between either of the loop wires and a good earth point such as a metal radiator. There should be an infinitely high reading ie no connection at all. Any reading indicates a failure of the loop cable insulation and you will need to either repair or replace the loop cable.

2) Instability can be caused by using poor quality signal cables, long unbalanced (2-wire) signal runs to the inputs, or by running input cables in close proximity with the loop wire over any appreciable distance. Loop amplifiers are capable of delivering high currents at audio frequencies. If the loop cable is run close to sensitive signal cables it may be possible to induce a signal back into the input of the amplifier causing feedback. Cable runs and loop wires should be kept well apart from each other. To avoid interference a proximity of 300mm should only be run for a few meters.

3) Instability can cause the amplifier to run hot and may result in the OVERHEAT LED illuminating.

### **Interference**

1) Background magnetic field signals or interference may be present in any location and may not be anything to do with the loop system. Monitor this with a loop receiver (such as an ILR3). If the interference is still present with the loop system switched off, then you need to locate and eliminate the source of interference before switching the loop system back on.

2) AC power hum can be introduced into the system if signal cables are grounded at multiple points. This can cause earth currents to flow around the screen wires of signal cables and introduce unwanted noise into the audio path. The unit has an EARTH LINK switch which can be used to lift the earth connection to the internal circuits and help solve mains hum problems. The case of the equipment remains grounded at all times for safety protection.

3) Magnetic fields can be induced into any low impedance electrical path or loop. Multiple ground earth systems may experience the pick up of the loop signal, and cause difficulties with other systems that are not designed to reject such interference. Check entire sound system for evidence of loop signal, and trace source of pick-up.

4) Under certain circumstances, the loop signal may appear as jagged lines or hum bars on a CCTV picture. This is could be due to running CCTV (low impedance unbalanced 2-wire circuit) cables in close proximity to the loop cable. Separate the cables to reduce the effect.

5) Remote (and apparently unconnected) PA systems can sometimes pick up loop signals. This is usually because the loop cable becomes damaged (see point 1 of Instability) or induces signals into the remote system through long unbalanced cables. Always run long audio signal cables as 3-wire balanced circuits & keep away from loop cables.

6) See also point 1 of Instability.

### **ACCESSORIES**

Details of all products & services provided by Ampetronic can be found at [www.ampetronic.com](http://www.ampetronic.com)

Wall mount brackets are available for mounting the amplifier on the wall with appropriate fixings.

Microphone pre-amplifiers for 1, 2 or 5 microphones, as well as other line level signals. These can be powered from either the  $\pm 15V$  DC power socket on the rear of the unit, or a stand alone power supply.

Signal processing units are available for use with low spill array systems.

Input adaptors for a range of applications such as 100V line audio & low Z speaker systems are available.

## TECHNICAL SPECIFICATIONS

### AC Power Supply:

3-pole IEC320 connector.  
85W nominal for either version.  
45-65Hz

### 230V Version

Nominal: 230V AC  
Fuse: T 630mA L  
Range: 207-253V AC  
Quiescent: 100mA  
Typical: 400mA (O/P 3A<sub>RMS</sub> pink noise)

### 120V Version

Nominal: 120V AC  
Fuse: T 1.25A L  
Range: 108-132V AC  
Quiescent: 200mA  
Typical: 800mA (O/P 3A<sub>RMS</sub> pink noise)

### Microphone Input:

XLR socket.  
Input Impedance: 200-600  
Sensitivity: -70dBu (245uV<sub>RMS</sub>) for full output.  
Overload: >-5dBu (436mV<sub>RMS</sub>)

### Line Input:

6.4mm 3-pole Jack socket.  
Input Impedance: 1M  
Sensitivity: -30dBu (24mV<sub>RMS</sub>) for full output.  
Overload: >+20dBu (7.75V<sub>RMS</sub>)

### Slave I/O:

6.4mm 3-pole Jack socket.  
Input Impedance: 100k  
Source impedance: 220  
Output level: 0dBu (0.775V<sub>RMS</sub>)

### Compression (AGC):

>36dB dynamic range  
Controlled by adjusting input level.

### Loop Design:

Depends on application, see  
Designing induction loops handbook  
(supplied) or consult Ampetronic.

### Output:

Wieland ST17/2 connector.  
Current: >9A peak into 1  
Voltage: >20V peak  
Loop Resistance: 0.3 to 2.0  
resistive or 2.2 max impedance  
reactive at 1.6kHz.  
THD+N <0.2% @ 1kHz @ 9.0A<sub>pk</sub>

### Frequency Response:

Measured at low level with no metal  
loss correction.  
80Hz to 6.5kHz -3.0dB  
100Hz to 5.5kHz ± 1.5dB

### Metal Loss Correction:

0dB (flat) to 3dB/Octave boost.  
Gain at 1kHz remains constant.

### Loop Monitor:

3.5mm 3-pole (stereo) jack socket  
0.675V<sub>pk</sub> at 9.0A<sub>pk</sub> output

### ±15V 150mA DC Output:

3 pin power Mini DIn socket.  
Regulated DC output for powering  
Ampetronic pre-amps & accessories.

### Environmental:

Ventilation: See **Installation** section  
for details.  
Ambient temperature: -10°C to +40°C  
Relative Humidity: < 90%  
IP rating: IP20

Physical: Weight: 3.75kg  
Width: 430mm  
Depth: 220mm  
Height: 44mm  
19" rack width, 1U high.

### Standards:

Meets relevant CE, EMC and  
safety standards.

*Please contact Ampetronic if you need  
further assistance.*

## **WARRANTY**

This product carries a five year parts and labour warranty which could be invalidated if these instructions are not followed correctly, or if the unit is misused in any way.

The five year warranty is dated from the time the equipment leaves Ampetronic and NOT when it is installed.

## **DECLARATION OF CONFORMITY**

Manufacturer: Ampetronic Ltd.  
Northern Road,  
Newark,  
Nottinghamshire.  
NG24 2ET  
United Kingdom.

Declares that the product:

Description: Induction Loop Driver  
Type name: ILD500

Conforms to the following Directive(s) and Norm(s):

Directive 89/336/EEC  
EMC: EN55103-1 : 1997 Emission  
EN55103-2 : 1997 Immunity  
Directive 73/23/EEC  
Safety: EN60065: 2002

Date October 2005  
Leon Pieters  
Technical Director,  
Ampetronic Ltd.