

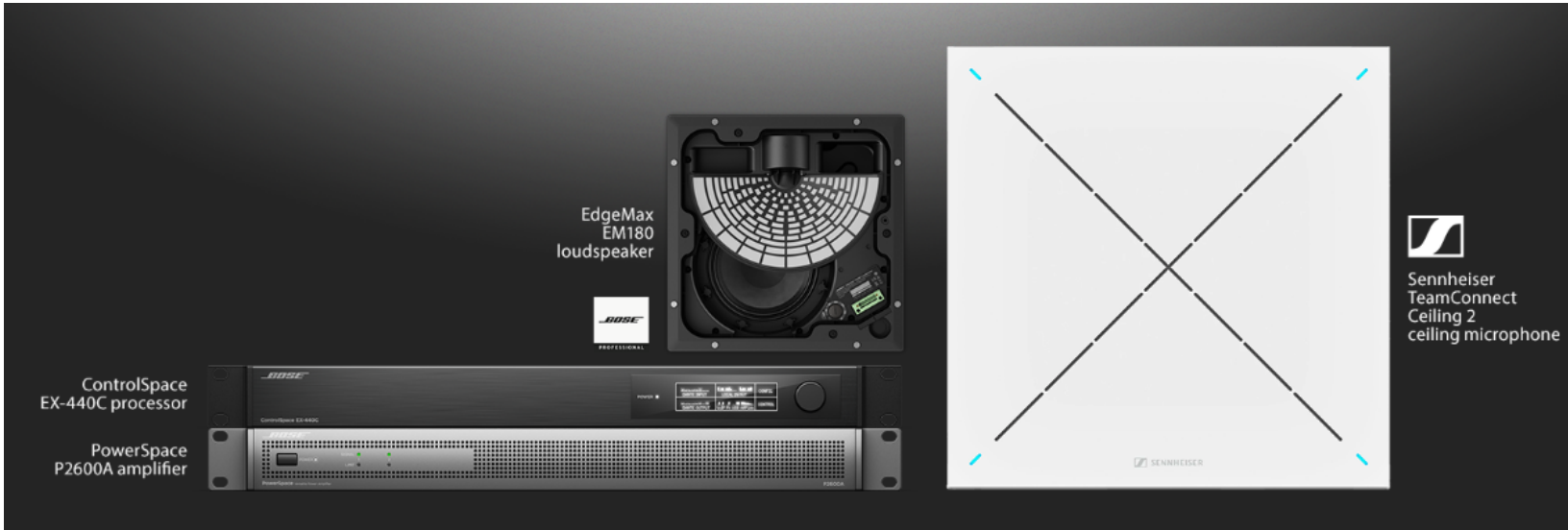

April 2020



Application Guide

**ES1 Ceiling Audio Solution**

Microsoft Teams Certified  
Medium Room System

Page Intentionally Left Blank

## Application Guide

### ES-1 Audio System Set-up Guide for Microsoft Teams



The Bose ES1 Ceiling Audio Solution is Microsoft Teams certified as part of a complete system solution that includes the following components:

- Bose ControlSpace EX-440C
- Bose PowerSpace P2600A (includes AmpLink cable)
- Bose EdgeMax EM180
- Sennheiser TeamConnect Ceiling 2 (TCC2)

Additional components required, but not included:

- Microsoft Teams Room camera and display
- Network switch with PoE for Dante and ControlSpace configuration
- Windows computer with [ControlSpace Designer 5.8.2](#) or later, Sennheiser Control Cockpit, and Dante Controller. (The computer is required for adjustments only and can be disconnected after use.)

### System Diagram

The system diagram for ES1 appears below. Components in the background (such as Microsoft Teams Room [MTR] components, camera, and network switch with PoE) are required but are outside the scope of ES1.

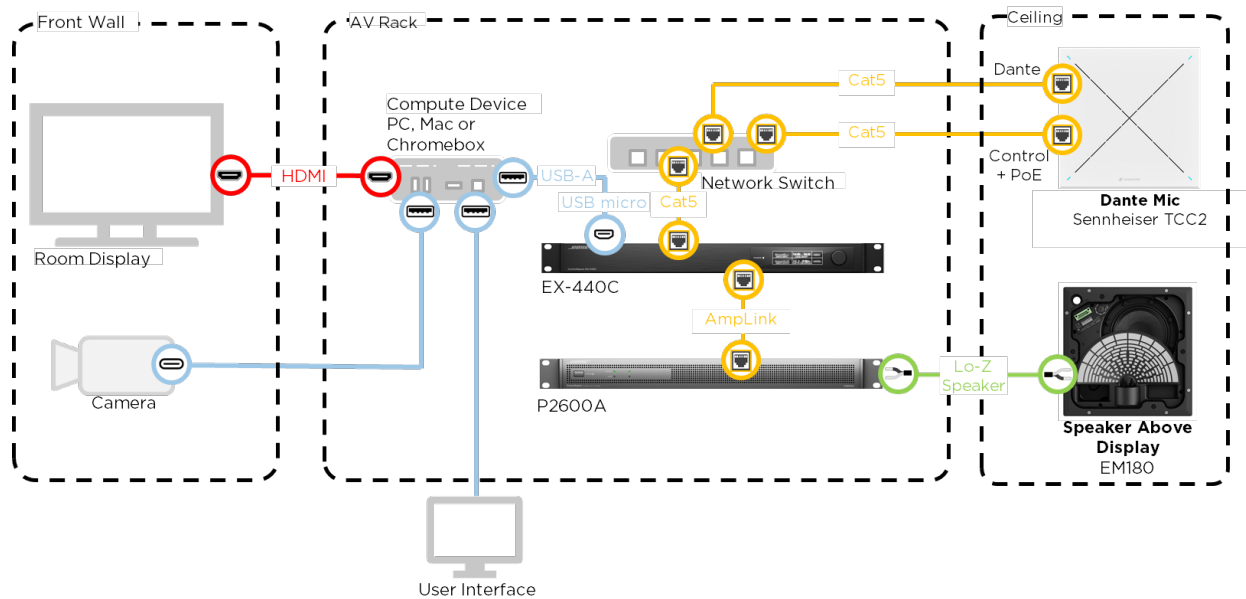

Figure 1: ES1 System Wiring Diagram

### Microphone and Loudspeaker Placement

EdgeMax EM180 includes patented PhaseGuide technology, which produces an asymmetrical dispersion pattern that directs audio down and forward (see Figure 2). Placement in the ceiling above the display draws participant attention toward the front of the room during a video conference. Audio disperses wall-to-wall, at 180 degrees, horizontally (see Figure 3).

This directionality requires that the PhaseGuide is properly oriented during installation. Wire the EM180 for 8Ω (low-Z). Refer to the [EdgeMax EM90 & EM180 installation guide](#) for proper installation instructions.

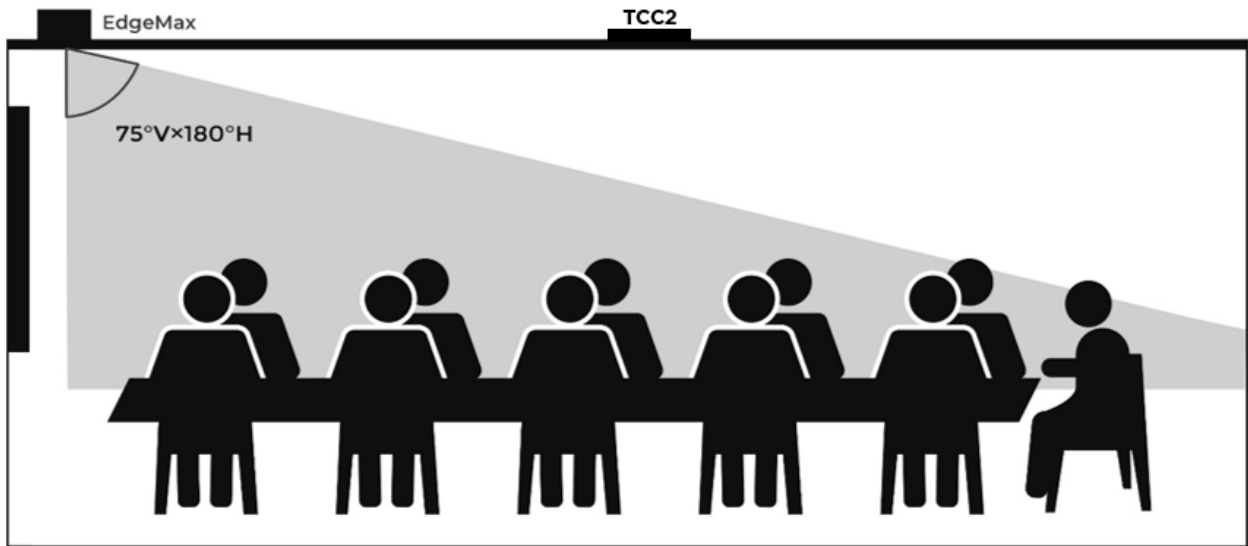

Figure 2: Side view of EdgeMax EM180 75-degree vertical dispersion and placement

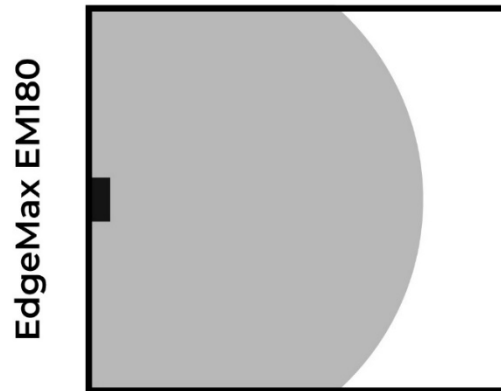

Figure 3: Top view of EdgeMax EM180 180-degree horizontal dispersion

## Application Guide

### ES-1 Audio System Set-up Guide for Microsoft Teams

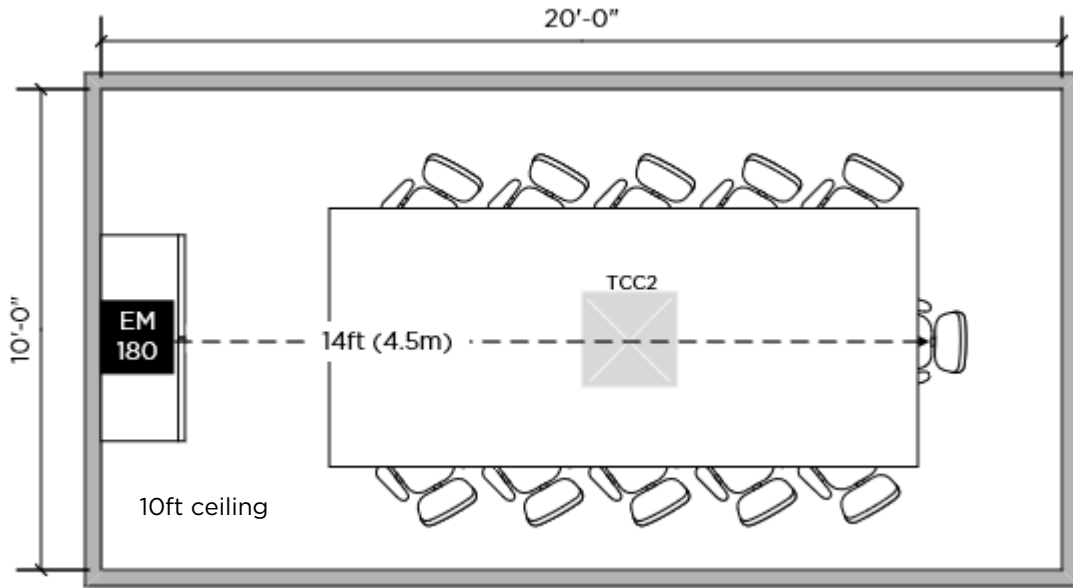

Figure 4: Plan view showing the relative placement of TCC2 and EM180.

The ES1 base configuration, including one EM180 loudspeaker, is optimized for a 20-foot (6.1-meter) conference room where the farthest listener is 14 feet (4.5 meters) away from the loudspeaker. The TCC2 should be positioned to provide a line-of-sight path to each seat at the table and should be no more than 11.5 feet (3.5 meters) from the farthest presenter.

### Amplifier with AmpLink

P2600A is a two-channel versatile amplifier with 600 watts per channel and the ability to assign high-Z and low-Z operation.

AmpLink is a proprietary near-zero-latency link between Bose processors and amplifiers and can carry up to eight channels of digital audio on a single shielded Category 5 (STP) cable. Connect the DSP and the **AmpLink Input** port on the amplifier as shown in (1) in Figure 5. The transmit channel is assigned within the AmpLink output block of the signal processor. On the amplifier-side, the appropriate receive channel is selected using the **Input Select** dial (2) set to the appropriate transmit channel. Turn the dial to **2** to select the first two AmpLink channels. The odd-number channel is assigned to Output 1 and the even channel is assigned to Output 2 (4). A 3-foot (1-meter) AmpLink cable is included with the amplifier.

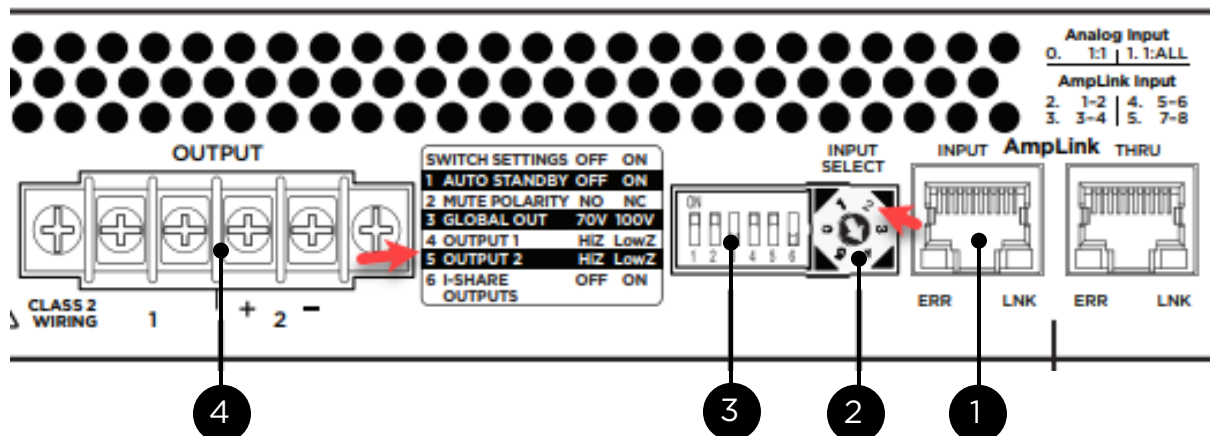

Figure 5: Back panel view of the amplifier with important elements identified.

## Application Guide

### ES-1 Audio System Set-up Guide for Microsoft Teams



The outputs of the P2600A can be individually assigned to high-Z (70V/100V) or low-Z using the **DIP switches** at (3) in Figure 5. DIP switches 4 and 5 correspond to Outputs 1 and 2, respectively. To connect low impedance to the EM180, set **DIP switch 5** to the **ON** (up) position.

**Note:** For more information on the setup and installation of P2600A, refer to the [PowerSpace installation guide](#).

### TCC2 and DSP Networking

The ControlSpace EX-440C and TeamConnect Ceiling 2 (TCC2) microphone array are both Dante products. Connecting the Sennheiser TCC2 microphone array requires two Cat 5 ethernet cables. The Dante **Primary** port and the **Ethernet** port on the TCC2 connect to the network switch.

**Note:** Refer to the [TeamConnect Ceiling 2 Instruction manual](#) for more information.

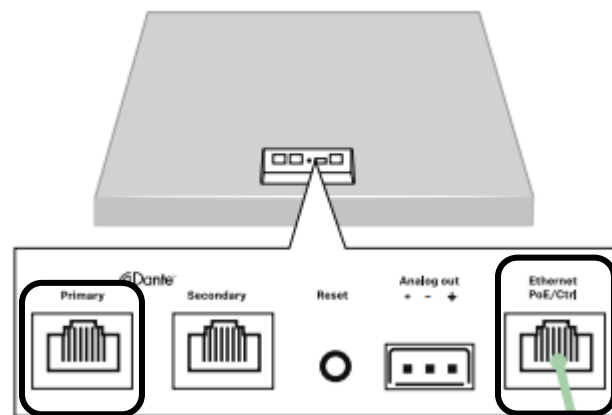

Figure 6: Connections for TCC2 require one cable for Dante (Primary) and Ethernet (POE and Control)

On the DSP, connect a single network cable to the Dante **Primary** port. The default configuration of the EX-440C processor is Switched mode. In this configuration, both Dante (audio) and control (all other operations) traffic is passed over a single network cable to the switch. In this configuration, **Do not connect a second network cable**. Connecting a second network cable from the processor to the switch will result in a spanning tree.

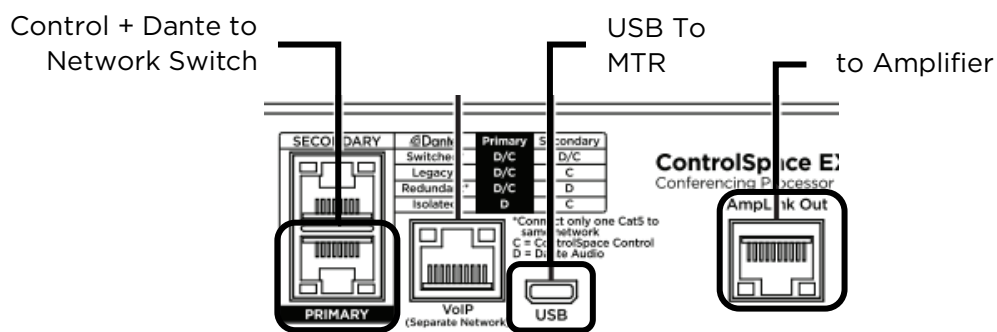

Figure 7: Connections for EX-440C showing Dante/Control, USB, and AmpLink

**DSP Configuration**

A reference file configuration file is available for download with preconfigured settings. This reference file is available for download from [PRO.BOSE.COM](http://PRO.BOSE.COM).

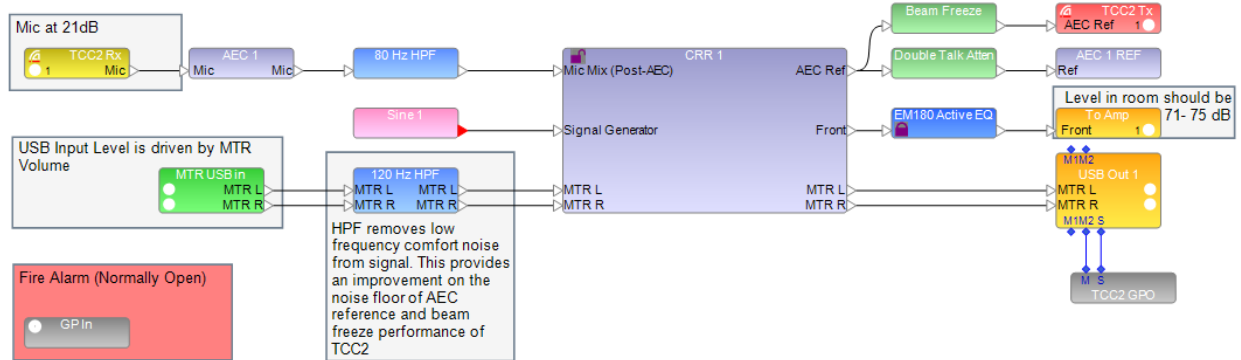

Figure 8: Reference configuration for ES1

## Application Guide

### ES-1 Audio System Set-up Guide for Microsoft Teams



A control object for the TCC2 integrates some important control parameters into the processor.

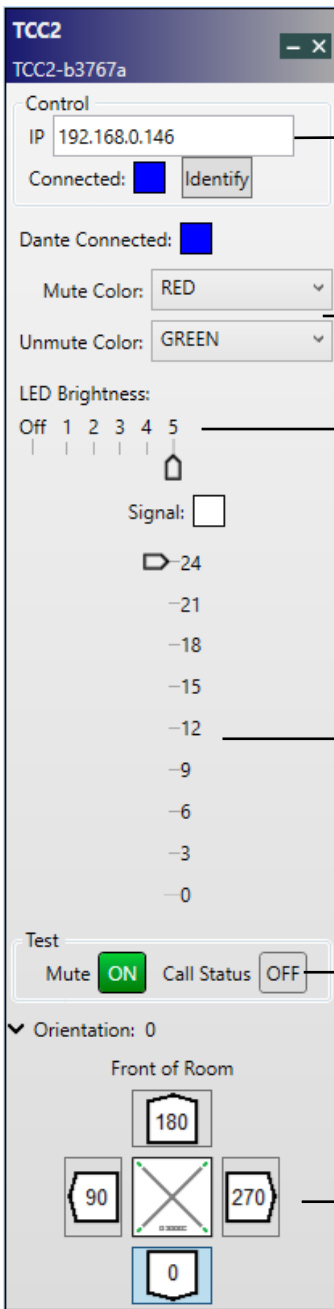

#### Control IP Address

Input the Control IP address of the TCC2, and then press **Enter**. The indicator box will be highlighted in blue to confirm the connection. A connection to the processor must be established to control all of the parameters in this object.

#### LED Colors

Select the color of the LEDs in the Mute and Unmute states. For Microsoft Teams, the default colors are:

**Mute:** Red  
**Unmute:** Green

#### LED Brightness

Use the fader to set the LED brightness when the LEDs are on. Select among five brightness levels. Select **Off** to turn the LEDs off.

#### Digital Output (Dante) Gain

This fader selects the gain of the microphone, per the room.

#### Logic Test

**Call Status** can be used to turn the LED off via logic operations when not in a conference. Turning the LED off is an operation of the **LED Brightness** setting; when turned on, the LED will illuminate at the previously configured brightness setting.

#### Microphone Orientation

Orientation is determined from a top-down view. Positions are based on the direction in which the Sennheiser logo is pointing. The default position of the Sennheiser logo is **0** degrees.

Figure 9: Control panel for Sennheiser TCC2 with description of controls and indicators



## Application Guide

### ES-1 Audio System Set-up Guide for Microsoft Teams



There are three signal processing blocks in ControlSpace Designer for the TCC2: (1) Dante Receive, (2) Dante Transmit, and (3) GPO Control. These three components are shown in Figure 10, below:

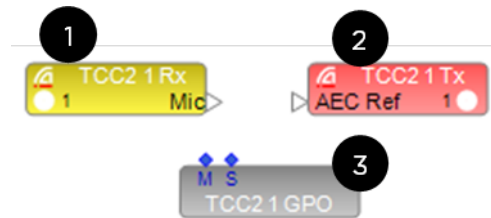

Figure 10: Sennheiser TCC2 elements in ControlSpace Designer

Dante Receive (1) is the input from the TCC2 output, and Dante Transmit (2) is a return channel to the TCC2 to enable the beam freeze operation. When the Dante IP range is the same as the Control IP range, the Dante subscriptions will route automatically—a special feature of the ControlSpace ecosystem.

The GPO Control block (3) contains logic connections that wire to the USB output to drive LED synchronization on the TCC2. LED control requires that the Control IP address has established a connection between the TCC2 and the DSP, as indicated by the blue indicator on the Control block. The LED **OFF** state is controlled through the **LED Brightness** setting.

#### Setting EX-440C as the Audio Device within the Microsoft Teams Room System

The EX-440C connects to the Microsoft Teams Rooms (MTR) system through from the USB host via a micro-USB connection.

Setup and deployment of specific Microsoft Teams Rooms (MTR) hardware may vary. Refer to the manufacturer's documentation for proper operation. The EX-440C processor performs as an **Echo Cancelling Speakerphone** when connected to any Microsoft Teams Room system.

After connecting the DSP to the MTR, the EX-440C must be set up as the audio device within the MTR that will be used for all Teams calls. To do this:

1. Select **More** in the Teams Room user interface.

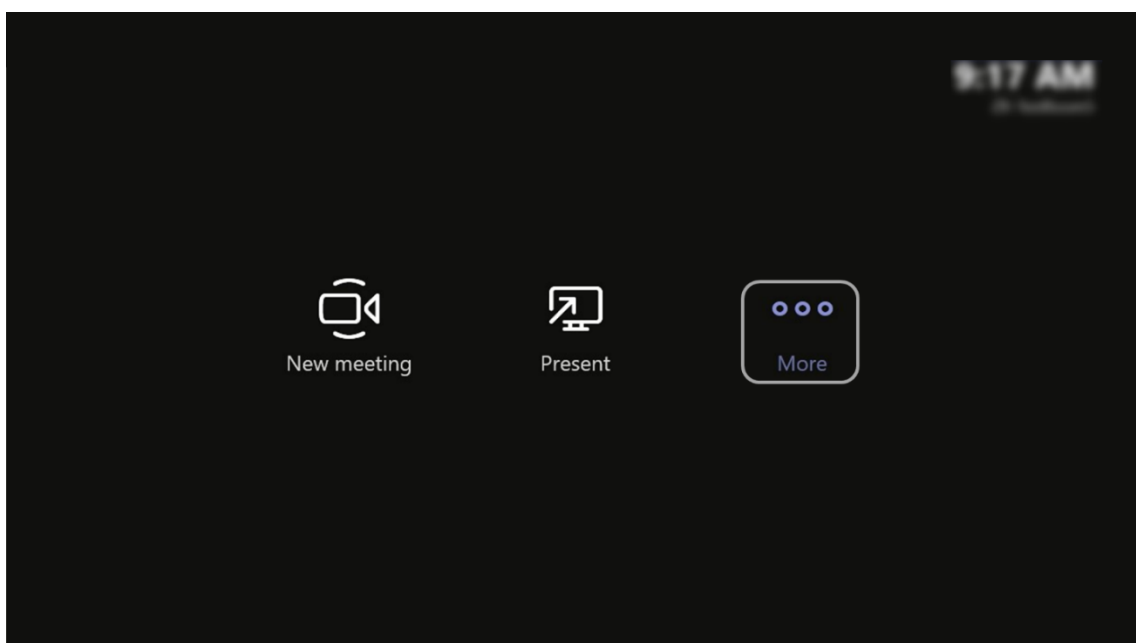

Figure 11: View of MTR user interface

2. Select **Settings**.

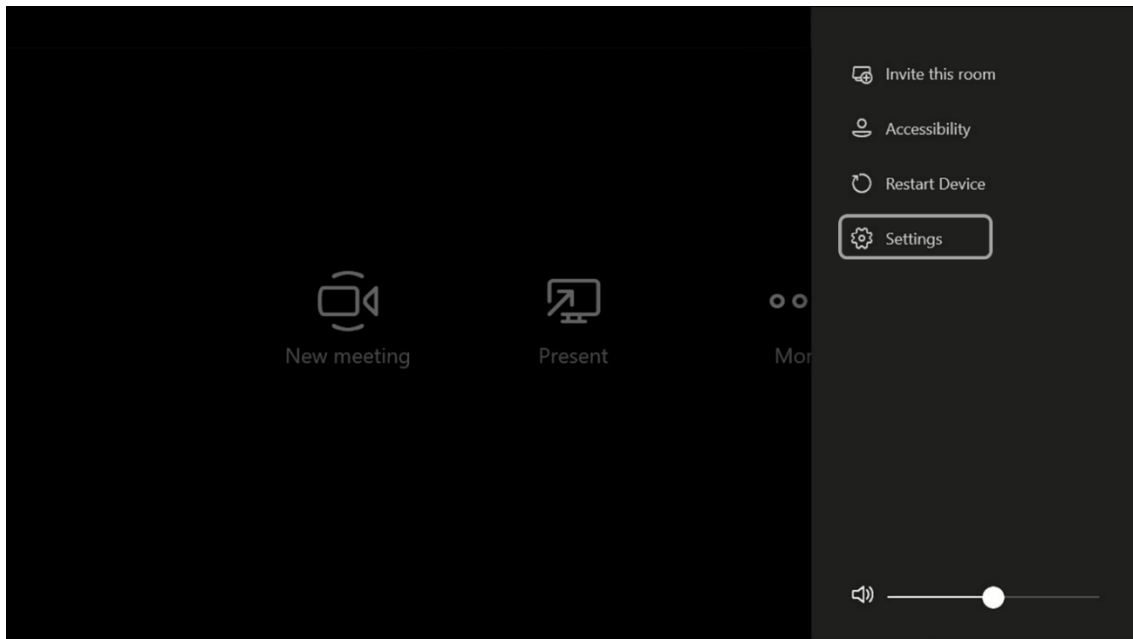

Figure 12: View of MTR user interface showing where to access the settings.

3. In the **Settings** menu, select **Peripheral** (as shown in Figure 13), and use the drop-down menus to select the EX-440C for each of the three parameters: **Microphone for Conferencing**, **Speaker for Conferencing**, and **Default Speaker**. When you are finished, click **Save and exit** to return to the user interface.

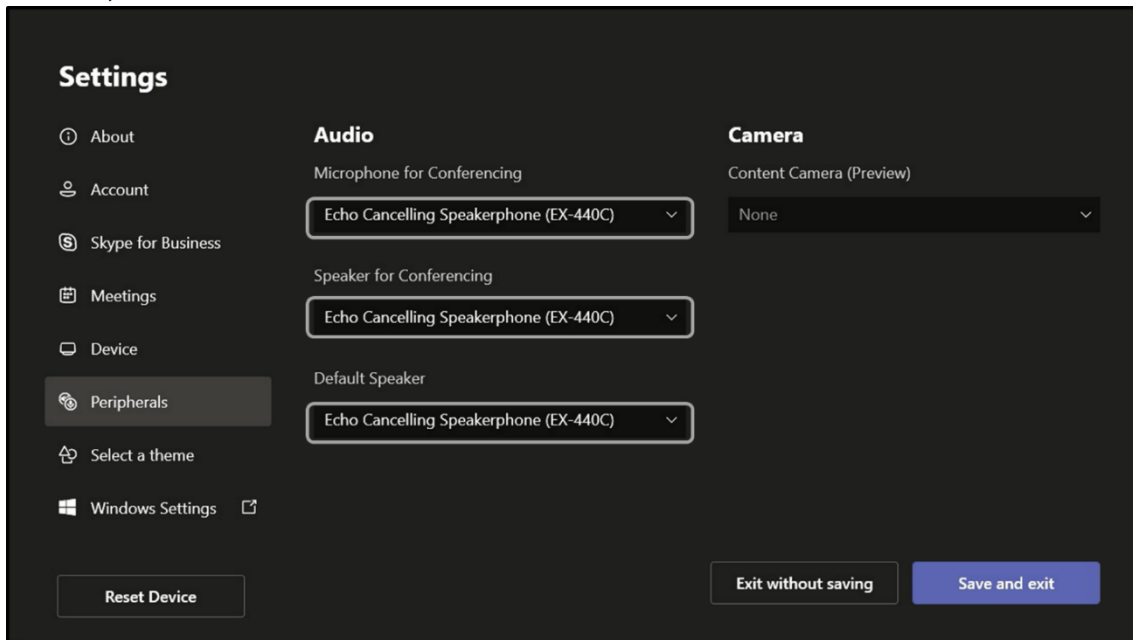

Figure 13: View of MTR settings

When using the EX-440C, MTR disables its internal acoustic echo cancellation (AEC) audio processing so that all audio processing is completed through the external DSP—the EX-440C. This provides the best audio performance.

## USB HID Communication Logic and Control

## Application Guide

### ES-1 Audio System Set-up Guide for Microsoft Teams



After selecting the audio device in the Microsoft Teams Room settings, the MTR uses USB Human Interface Device (HID) signaling to proxy call status and controls to the processor. HID functions are always active in the MTR and in the EX-440C.

HID synchronizes the call status and microphone privacy state with the LEDs on the TCC2. Privacy Mic Mute status and Call Status are synchronized through the EX-440C **USB Out** block. The volume level of the **USB In** block is controlled by the loudspeaker volume adjustments in the user interface. The following table describes the USB HID synchronization functions and affected parameters.

MTR Function	EX-440C Block	Parameter Changed by HID signal
Privacy Mic Mute	USB Output	Mute
Call Status	USB Output	Status Logic Port
Loudspeaker Volume	USB Input	Volume Level

The **M1** and **M2** logic port on the bottom of the USB Out block correspond to microphone mute; and **S** associates with call status. HID mute and volume synchronize both USB channels. To enable control of the TCC2 LEDs, the logic ports from the bottom of the USB Out block are wired to **M** and **S** on the TCC2 GPO block as shown in Figure 14.

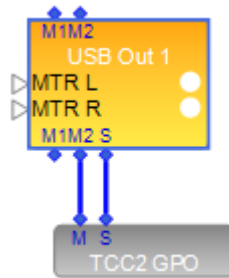

Figure 14 Logic wiring from the USB Out block to the TCC2 GPO block

Only the input to the MTR is muted at the USB output. The mic does not mute even though the LEDs on the TCC2 change color. The following table summarizes the port function and default state for each HID operation:

Function	Logic Port	State	Default TCC2 LED Color/State
Call not connected	S	Low	Off
Call connected	S	High	On
Unmute	M1/M2	Low	Green
Mute	M1/M2	High	Red

The Sennheiser TCC2 is controlled by sending command strings over IP from the ControlSpace EX-440C processor. Type the microphone control IP address in the **Control IP** field of the TCC2 control object and then press **Enter**.

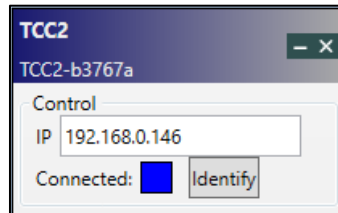

Figure 15: Control IP field of the TCC2 control object

The Microsoft Teams Room system room volume control is set to 50 by default, and the microphone is unmuted when a new meeting is started. When a meeting is started, the TCC2 LED will change from off to green. Pressing microphone mute on the MTR changes the TCC2 LED to red. Ending the call turns the LED off.

### TeamConnect Ceiling 2 Setup and Configuration

The Sennheiser TCC2 is a ceiling-mounted dynamic beamforming microphone. It supports both Dante (input/output) and auxiliary-balanced analog (output) connections for audio transport. A PoE/Control connection and the Sennheiser [Control Cockpit](#) software are required to begin the setup process.

With the network cable attached to the TCC2 **Ethernet PoE/Ctrl** port, the browser-based Control Cockpit interface will detect and identify the TCC2 as shown below (using mDNS).

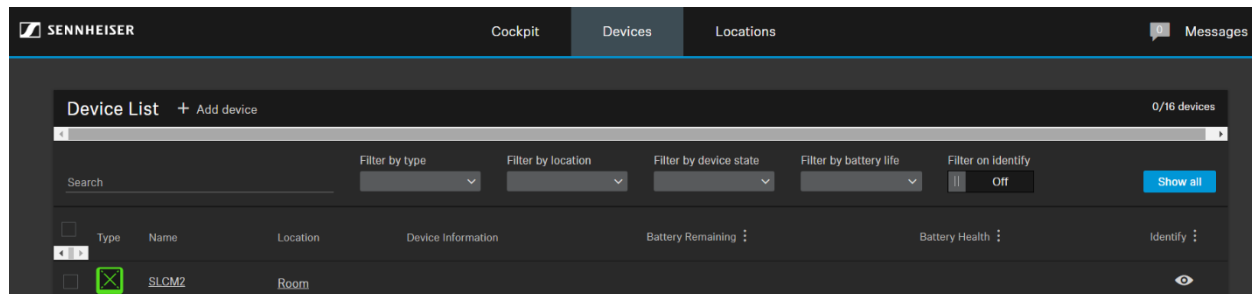

Figure 16: Control Cockpit interface

Selecting the unit to be configured from the Device List opens the device **Properties** window where system and audio parameters can be examined and edited.

The **Source Detection** section on the **Audio** tab (Figure 17) shows the current focus of the TCC2 automatic beam-steering, which can be tracked in real time. Click **Edit** to manually configure vertical and horizontal exclusion zones (Figure 18), which prevents detection of noise and sounds in these zones (e.g., ceiling-mounted AC vents, projector fans, doors credenzas).

In some reverberant environments, applying an exclusion zone, directed toward the front of the room and in the direction of the EM180 can improve AEC performance.

**Note:** Refer to the [TeamConnect Ceiling 2 instruction manual](#) for more information.

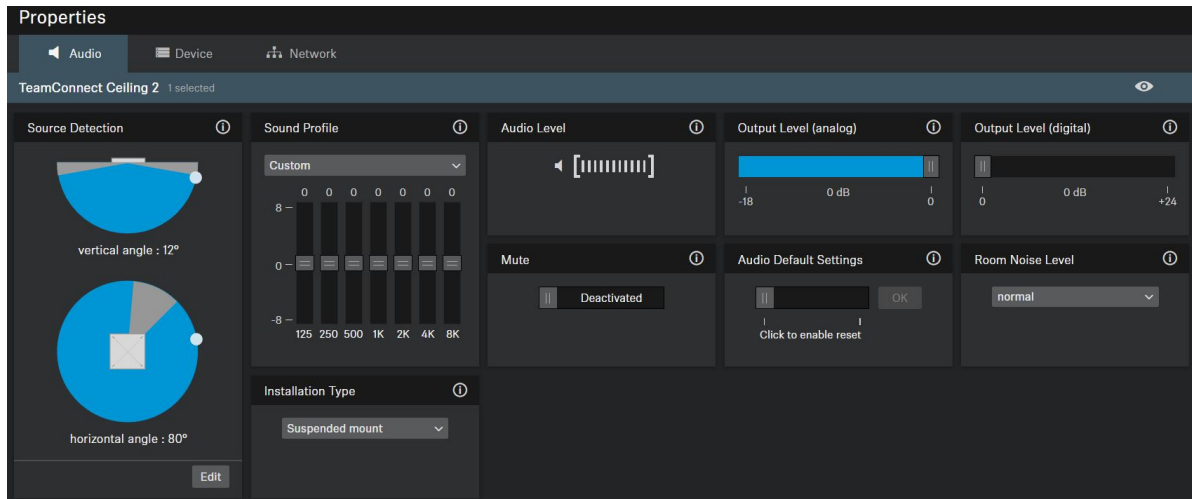

Figure 17: Properties window

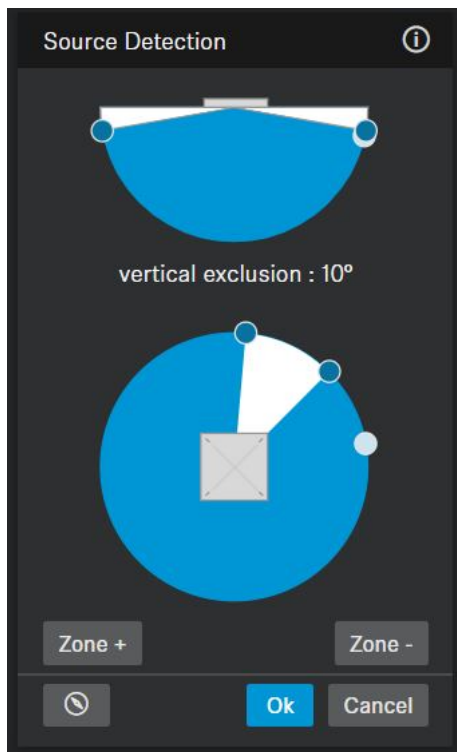

Figure 18: Control Cockpit interface

### Levelling the TCC2 Beam Freeze

The far-end signal (the signal received from the far-end presenter) can be routed from the DSP to the TCC2 **AEC Ref** input via Dante. This AEC reference signal is used inside the TCC2 to steer the beam into a static status (at 315° horizontally and 90° vertically) at any time when the far-end presenter is active. The Static status is enabled when the level of the AEC reference signal exceeds a certain threshold. In order to ensure appropriate functionality of this feature, it is crucial to adjust the level of the AEC reference signal. Optimally, the level of the AEC reference signal should be adjusted in such a way that the Static status is not active when the far-end presenter is not active.

In more challenging acoustic environments, this beam freeze can improve far-end echo cancellation.



#### **Finding the Correct Level for the AEC Ref Signal**

Set up a test call where the far-end presenter is unmuted but remains quiet. In the control software for the AEC, set the output level for the AEC ref signal to the minimum level. This allows the position of the near-end presenter to be tracked properly, never reaching the Static status. The Static status is indicated in Sennheiser Control Cockpit by a direction of 315 degrees horizontally and 90 degrees vertically. When the output level of the AEC reference signal is increased steadily, at a certain point the static status becomes active and the displayed position in Sennheiser Control Cockpit is fixed at 315 degrees horizontally and 90 degrees vertically. Find the level where the static status starts to become active with a quiet far-end. When this threshold is found, reduce the output level of the AEC reference signal by 15 dB to 20 dB. A Gain Control block is provided between the AEC reference and Dante Tx, provided for this purpose.

#### **Fire Alarm Override**

Some municipal building codes require that the output of an amplified audio system is muted when a fire alarm is triggered so that the alarm and any announcements can be heard.



**Troubleshooting and Commissioning Guide**

<p>The TCC2 does not connect.</p>	<p>From the front panel OLED display, confirm that the EX-440C is in the same IP range as the TCC2 by using Sennheiser Control Cockpit.</p> <p>Confirm that the correct IP address is specified for the TCC2 Control page. An indicator appears when connected.</p>
<p>The LEDs of the TCC2 do not change.</p>	<p>Confirm that the EX-440C is selected as the microphone within the MTR admin settings.</p> <p>Connect the corresponding <b>M</b> (mute) logic port and <b>S</b> (call status) logic port from the USB logic to the TCC2 logic block.</p> <p>Verify that the control IP address from the TCC2 is specified in the Control object.</p>
<p>There is no audio output in the room.</p>	<p>Confirm that the EX-440C has been selected as the loudspeaker in the MTR admin settings.</p> <p>Confirm that the Amplink connection from the EX-440C is connected to the <b>Amplink Input</b> port on the amplifier (not the Amplink Thru port).</p> <p>Confirm that the <b>Input Select</b> dial is set to <b>2</b>.</p>
<p>Volume level in room is too low.</p>	<p>The default MTR level for every new meeting is <b>50</b>. To adjust the MTR level in the room, adjust the volume level in the MTR user interface to approximately 80 to 90 percent. Next, raise the Amplink output to a suitable level.</p> <p>Confirm that the EM180 loudspeaker tap is set to <b>8Ω</b>.</p>
<p>The room has several reflective surfaces.</p>	<p>Set the Non-linear Processing (<b>NLP</b>) setting in the AEC to <b>Medium</b> to eliminate residual echo that may be heard by far-end participants while speaking.</p> <p>Use the horizontal and vertical exclusion zones in the TCC2 to remove detection areas that may be problematic.</p>
<p>There is background noise in the room.</p>	<p>Use the horizontal and vertical exclusion zones in the TCC2 to remove detection areas that may be problematic.</p> <p>AEC processing includes Noise Reduction (NR) to reduce steady state background noises, such as HVAC and projector fans that are detected by the microphone. Increase the NR to reduce the amount of noise that is detected.</p>



## Common Questions

### 01| Microsoft Teams Room Device is not in the rack. How can I extend the USB connection?

You can use the Icron USB 2.0 Ranger 2301, which has been tested.

### 02| What settings do I need to change in the configuration file?

The reference configuration settings provide an excellent starting point, but it is expected that some adjustments may be required because room conditions vary. Refer to the **Troubleshooting and Commissioning Guide** section of this document.

### 03| What are the requirements of the network switch?

The network switch provides PoE power to the microphone over one of the two cables. Refer to Audinate support for information about network switches that are Dante-compliant.

### 04| Can I mount the EM180 in a soffit?

Yes, you can pre-install the EdgeMax EM180 rough-in pan (790054-0010).

### 05| Which mounting options are available for TCC2?

The Sennheiser TCC2 supports lay-in flush mounts in acoustic ceiling grids. In the US, a bracket kit is required to adapt the microphone to a 24 x 24-inch grid. Additionally, the microphone can be surface-mounted in hard ceilings, or pole-mounted or wire-mounted in open ceilings. Refer to the [TeamConnect Ceiling 2 instruction manual](#) for proper mounting instructions.

---

©2020 Bose Corporation. All rights reserved. Information subject to change without notice. Bose, ControlSpace, EdgeMax, PhaseGuide, and PowerSpace are trademarks of Bose Corporation. Audinate and Dante are registered trademarks of Audinate Pty Ltd. Microsoft Teams™ is a trademark of Microsoft Corporation. Sennheiser is a trademark of Sennheiser GmbH. All trademarks are those of their respective owners.

For Bose technical support, visit [pro.bose.com/en\\_us/support.html](https://pro.bose.com/en_us/support.html)

For Sennheiser technical support, visit [sennheiser.com/service-support](https://sennheiser.com/service-support)

Bose ES1 Ceiling Audio Solution is certified for Microsoft Teams.

