

MIPRO®

Wireless Conference Microphone Bases

User Guide

BC-100T



BC-24T



I. Part Names. Fig. 1

Front Panel

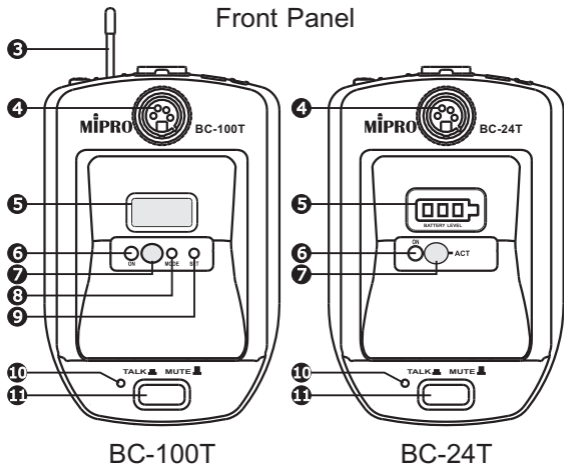

Back Panel

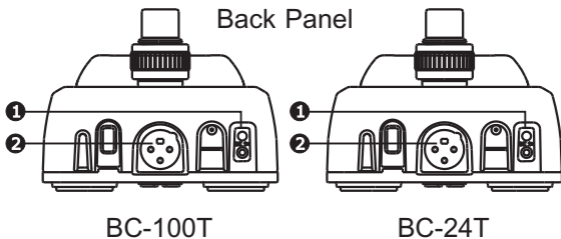

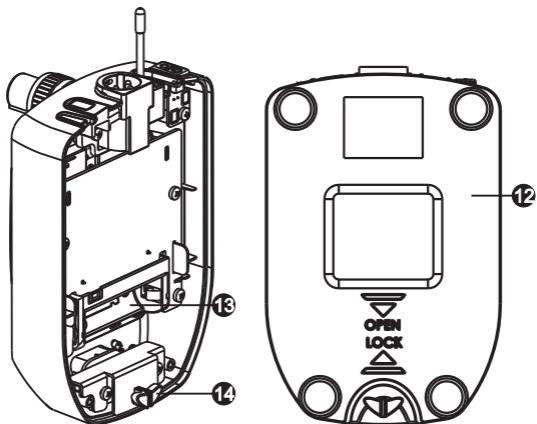

BC-100T / BC-24T

Fig. 1

- ① Charging Connector & Indicators.
- ② Balanced XLR Connector.
- ③ Transmitting Antenna.
- ④ Gooseneck Microphone Connector.
- ⑤ LCD Panel.
- ⑥ Power Button.
- ⑦ ACT Sync Window.
- ⑧ MODE Button.
- ⑨ SET Button.

- ⑩ TALK Indicator.
- ⑪ TALK or MUTE Button.
- ⑫ Base Cover.
- ⑬ Battery Compartment.
- ⑭ Base Cover Lock Knob.

II. Battery Insertion

1. Turn Base Cover Lock Knob ⑭ 180° to loosen the base cover. Push and slide down Base Cover ⑫ according to Fig. 2.

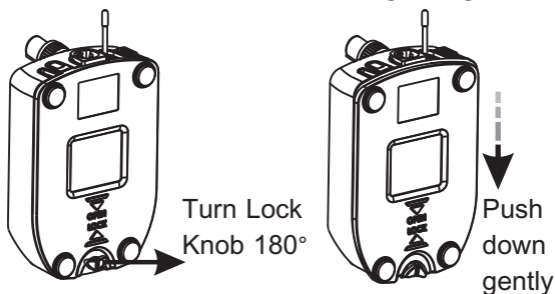

Fig. 2

2. Insert a charged 18500 type lithium battery according to its correct polarity according to Fig. 3.

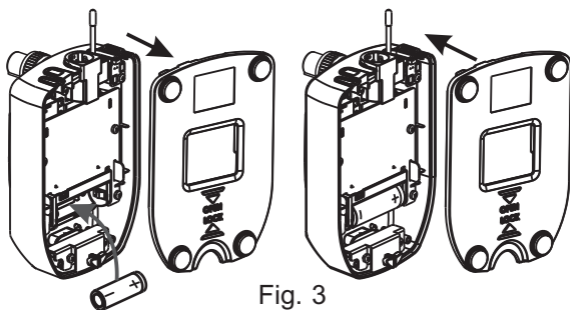

Fig. 3

3. Align and push up the Base Cover ⑫ and turn the knob ⑭ 180° for a secured closure. Push and hold Power Button ⑥ for 2 second to power on, Fig. 4.

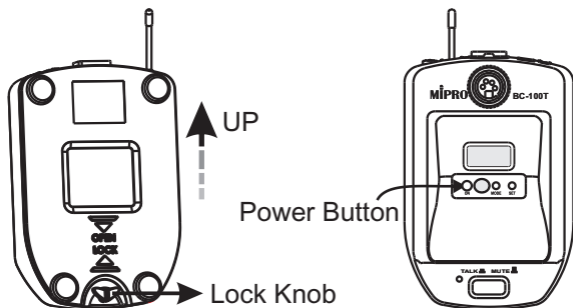

Fig. 4

III. Charging Method, Fig. 5

1. Plug the charger into the Charging Connector ❶ of the device and an AC outlet.
2. Charging (still red indicator).
3. Fully Charged (still green indicator).
4. If indicator is not lit after both ends are plugged in, check to see if the rechargeable battery is inserted correctly or is not inserted.

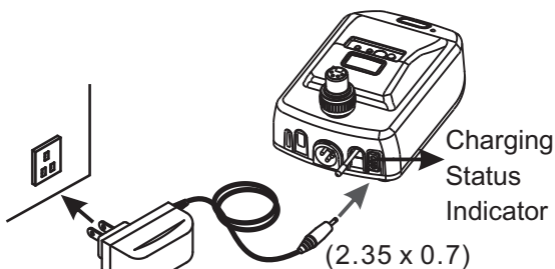

Fig. 5

IV. LCD Screen, Fig. 6



Fig. 6

- A1** Displays Functions.
- A2** Displays Parameters.
- A3** Battery Level Meter.

V. Operating Instructions

1. Press MODE button **8** to access all the functions.
2. Press SET button **9** once to denote a change. Existing parameter starts flashing. Press SET button second time to change the programmed parameters, Fig. 7.

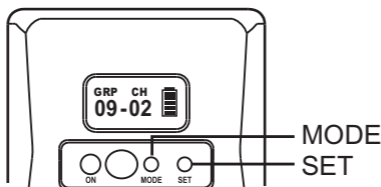

Fig. 7

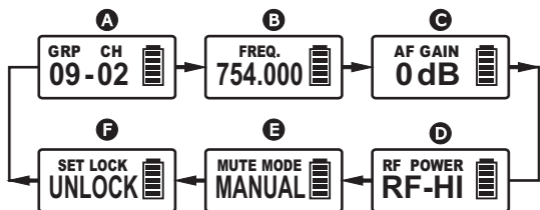

Fig. 8

- A** Group Channel.
- B** Frequency.
- C** AF Gain.
- D** RF Power.
- E** Mute.
- F** Lock/Unlock.

3. Group (GRP) / Channel (CH) / Frequency (FREQ.) are synced from receiver and cannot be changed, Fig. 9.



Group Channel



Frequency

Fig. 9

4. AF Gain Setting, Fig. 10:

- (A) AF Gain can be changed from 12dB ~ -12dB, in 6dB steps.
- (B) Press MODE button to access AF GAIN parameter. Press SET button to change. To save, press MODE button or until flashing stops.
- (C) The higher the AF gain is, the lower the input signal of dynamic range will be and it will increase noise and feedback chances.
- (D) Set AF Gain to -12dB for guitar.
- (E) 0dB is the factory default setting.

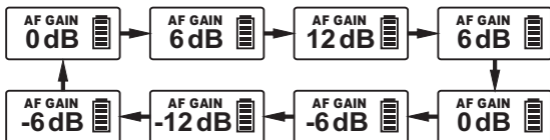

Fig. 10

5. RF Power Setting, Fig. 11:

- (A) RF Power can be changed to RF-HI or RF-LOW.
- (B) Press MODE button to access RF POWER parameter. Press SET button, the parameters start flashing. Press SET button again, the parameter will change circularly. Press MODE button to save or the parameter saves automatically when flashing stops.

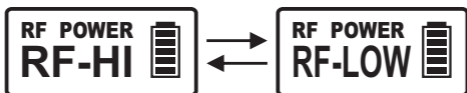

Fig. 11

6. MUTE MODE Setting, Fig. 12:

- (A) MUTE MODE can be changed to MANUAL or DISABLE.
- (B) Press MODE button to access MUTE MODE parameter. Press SET button, the parameters start flashing. Press SET button again, the parameter will change circularly. Press MODE button to save or the parameter saves automatically when flashing stops.
- (C) MANUAL mode indicates MUTE button can be muted.
- (D) DISABLE mode indicates MUTE button cannot be muted.



Fig. 12

7. LOCK Setting, Fig. 13:

- (A) LOCK can be changed to LOCK or UNLOCK.
- (B) Press MODE button to access LOCK parameter. Press SET button, the parameters start flashing. Press SET button again, the parameter will change circularly. Press MODE button to save or the parameter saves automatically when flashing stops.
- (C) LOCKED mode indicates power button cannot work and mute function is normal.
- (D) Repeat same procedures to change back to UNLOCK mode. UNLOCK mode indicates power is operational.

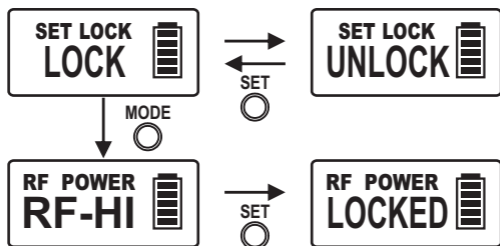

Fig. 13

VI. Battery Level Status

Replace with a charged battery once level falls to 10%. Device will power off automatically with an OFF message once power level falls too low, See Fig. 14.

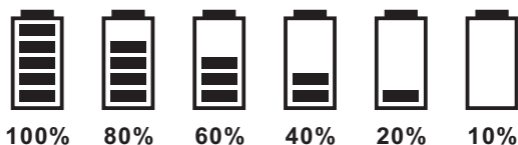

Fig. 14

VII. Power On/Off

1. Press and hold power button for two seconds to power on or power off the device.
2. The LCD screen display OFF... during powering off, See Fig. 15.



Fig. 15

3. Error codes:
 - (A) ERR no01→Channel wasn't programmed or internal data error.
 - (B) ERR no02→Testing only.
 - (C) ERR no03→The set frequency exceeds the upper band. The microphone frequency will not be changed but it can be operated as long as the power switch is turned on again.
 - (D) ERR no04→The set frequency exceeds the lower band. The microphone frequency will not be changed but it can be operated as long as the power switch is turned on again.
4. GROUP CHANNEL are internal programmed channels.
5. CHANNEL displays only (GROUP is not shown) indicates a user-defined frequency synced from receiver and it only can be changed via PC.

VIII. Installation and Operation of Wireless Gooseneck Microphone

1. Insert a MIPRO gooseneck microphone before power on to avoid potential noise.
2. Align the connectors and insert the microphone properly and secure tightly by turning counterclockwise, See Fig. 16.
3. Turn clockwise to loosen the microphone.

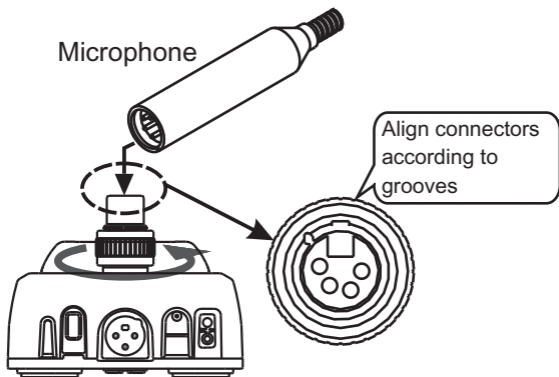

Fig. 16

4. Power on once the microphone is connected, See Fig. 17.

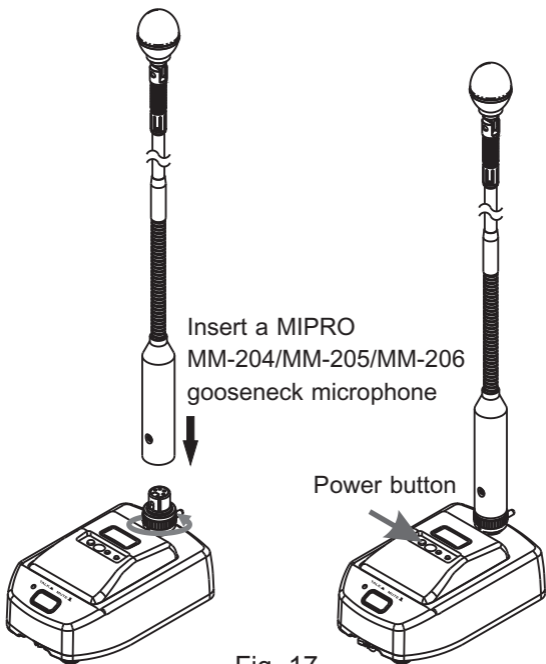
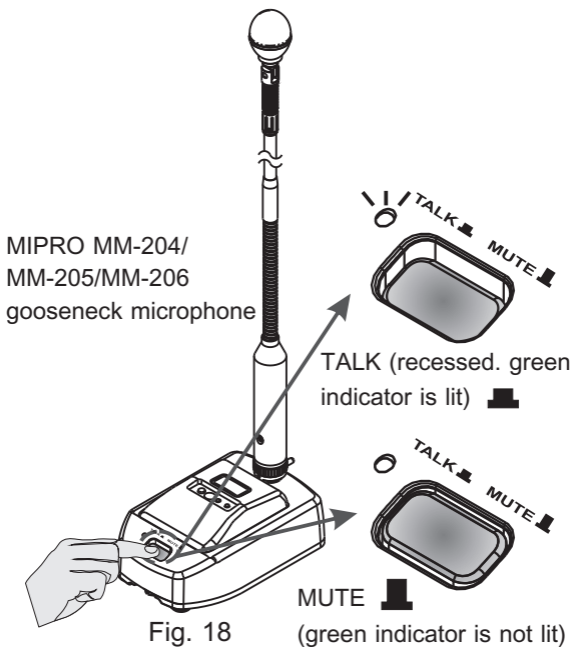

Fig. 17

5. Power on and press down TALK button to talk (recessed with a lit green indicator).
6. To mute talking, press down the MUTE button (green indicator is not lit), See Fig. 18. After use, be sure to turn off the power. Remove the battery if the device won't be used for a long time.



IX. Operation of Wired Gooseneck Microphone, Fig. 19

1. TALK mode (recessed. green indicator is lit). MUTE mode (green indicator is not lit). Same operation as the wireless gooseneck microphone.
2. Connect a XLR to XLR cable (not supplied) to both Wireless Conference Microphone Base and amplifying device to provide 12V ~ 48V DC phantom power, See Fig. 19. Remove the cable if the device won't be used for a long time.

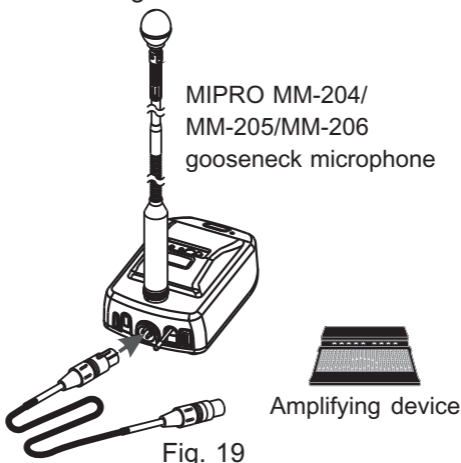

Federal Communication Commission Interference Statement

This equipment has been tested and found to comply with the limits for a Class B digital device, pursuant to Part 15 of the FCC Rules. These limits are designed to provide reasonable protection against harmful interference in a residential installation. This equipment generates, uses and can radiate radio frequency energy and, if not installed and used in accordance with the instructions, may cause harmful interference to radio communications. However, there is no guarantee that interference will not occur in a particular installation. If this equipment does cause harmful interference to radio or television reception, which can be determined by turning the equipment off and on, the user is encouraged to try to correct the interference by one of the following measures:

- Reorient or relocate the receiving antenna.
- Increase the separation between the equipment and receiver.
- Connect the equipment into an outlet on a circuit different from that to which the receiver is connected.
- Consult the dealer or an experienced radio/TV technician for help.

FCC Caution: To assure continued compliance, any changes or modifications not expressly approved by the party responsible for compliance could void the user's authority to operate this equipment. (Example - use only shielded interface cables when connecting to computer or peripheral devices).

FCC Radiation Exposure Statement

This equipment complies with FCC RF radiation exposure limits set forth for an uncontrolled environment. This equipment should be installed and operated with a minimum distance of 0.5 cm between the radiator and your body.

This transmitter must not be co-located or operating in conjunction with any other antenna or transmitter.

The antennas used for this transmitter must be installed to provide a separation distance of at least 0.5 cm from all persons and must not be co-located or operating in conjunction with any other antenna or transmitter.

This device complies with Part 15 of the FCC Rules.

Operation is subject to the following two conditions:

- (1) This device may not cause harmful interference, and
- (2) This device must accept any interference received, including interference that may cause undesired operation.

IC

This device complies with Industry Canada RSS-210

ISSUE 2 standards. Operation is subject to the following two conditions:

- (1) this device may not cause interference, and
- (2) this device must accept any interference, including interference that may cause undesired operation of the device.

Le présent appareil est conforme aux CNR d'Industrie Canada applicables aux appareils radio exempts de licence. L'exploitation est autorisée aux deux conditions suivantes:

- (1) l'appareil ne doit pas produire de brouillage, et
- (2) l'utilisateur de l'appareil doit accepter tout brouillage radioélectrique subi, même si le brouillage est susceptible d'en compromettre le fonctionnement.

MIPRO[®]
MICROPHONE PROFESSIONALS

MIPRO Electronics Co., Ltd

Headquarters : 814 Pei-Kang Road, Chiayi, 60096, Taiwan
Tel : +886.5.238.0809 Fax : +886.5.238.0803
www.mipro.com.tw mipro@mipro.com.tw

All rights reserved. MN 018/04



Do not copy or forward without prior approvals MIPRO.

Specifications and design subject to change without notice.



2 CE561B