

# AUDIO DISTRIBUTION NETWORK



**SENNHEISER ADN**  
Instruction manual

 **SENNHEISER**

# Contents

Important safety instructions .....	3
The Sennheiser ADN conference system .....	5
Available system components – scope of delivery .....	6
Overview of the components .....	7
ADN D1 delegate unit .....	8
ADN C1 chairman unit .....	9
ADN CU1 central unit .....	10
Overview of the ADN CU1 display panel .....	11
The “Conference Manager” software .....	12
The SDC CBL RJ-45 system cables .....	12
Structuring and controlling the conference system .....	13
Putting the conference system into operation .....	15
Preparing the central unit for use .....	15
Preparing the conference units for use .....	16
Setting up the conference system .....	17
Switching the conference system on/off .....	20
Using the central unit .....	21
Deactivating the lock mode of the central unit .....	21
Functions of the keys .....	21
Configuring the conference system via the central unit .....	22
Overview of the operating menu .....	22
Working with the operating menu .....	25
Adjusting the conference settings – “Conference” .....	26
Adjusting the audio settings – “Audio” .....	31
Checking the system and detecting problems – “System” .....	34
Adjusting the language – “Language” .....	41
Adjusting further settings – “Settings” .....	42
Running a conference .....	44
Operating a delegate unit .....	45
Operating a chairman unit .....	46
Setting the volume of the conference units’ built-in loudspeakers .....	48
Adding conference units to the conference system during operation .....	48
Using the “Conference Manager” software .....	49
Possibilities of usage of the software and the conference system .....	49
Preparing the central unit’s integrated software for use .....	50
Preparing the Windows version of the software for use .....	50
Starting/exiting the software .....	55
Getting to know and adjusting the basic features of the software .....	56
Using the conference system and the software .....	66
Preparing a conference and mapping a conference room – “Setup” operating mode .....	72
Initializing the conference units – “Setup” operating mode .....	86
Adjusting the conference settings – “Setup” operating mode .....	90
Controlling and monitoring a conference – “Live” operating mode .....	95
Using the log and diagnosis function – “Event Log” .....	102

Cleaning and maintaining the conference system ..... 104  
Updating the firmware of the conference system ..... 105  
If a problem occurs ... ..... 106  
Accessories ..... 108  
Specifications ..... 109  
Appendix ..... 111  
Manufacturer Declarations ..... 116

# Important safety instructions

1. Read these instructions.
2. Keep these instructions. Always include these instructions when passing the apparatus on to third parties.
3. Heed all warnings.
4. Follow all instructions.
5. Do not use this apparatus near water.
6. Clean only with a dry cloth.
7. Do not block any ventilation openings. Install in accordance with the manufacturer's instructions.
8. Do not install near any heat sources such as radiators, heat registers, stoves, or other apparatus (including amplifiers) that produce heat.
9. Do not defeat the safety purpose of the polarized or grounding-type plug. A polarized plug has two blades with one wider than the other. A grounding type plug has two blades and a third grounding prong. The wide blade or the third prong are provided for your safety. If the provided plug does not fit into your outlet, consult an electrician for replacement of the obsolete outlet.
10. Protect the power cord from being walked on or pinched, particularly at plugs, convenience receptacles, and the point where they exit from the apparatus.
11. Only use attachments/accessories specified by the manufacturer.
12. Use only with the cart, stand, tripod, bracket, or table specified by the manufacturer, or sold with the apparatus.  
When a cart is used, use caution when moving the cart/apparatus combination to avoid injury from tip-over.
13. Unplug this apparatus during lightning storms or when unused for long periods of time.
14. Refer all servicing to qualified service personnel.  
Servicing is required when the apparatus has been damaged in any way, such as power supply cord or plug is damaged, liquid has been spilled or objects have fallen into the apparatus, when the apparatus has been exposed to rain or moisture, does not operate normally, or has been dropped.
15. To completely disconnect this apparatus from the AC mains, disconnect the power supply cord plug from the AC receptacle.
16. **WARNING:** To reduce the risk of fire or electric shock, do not expose this apparatus to rain or moisture.
17. Do not expose this equipment to dripping or splashing and ensure that no objects filled with liquids, such as vases, are placed on the equipment.
18. The mains plug of the power supply cord shall remain readily operable.



### Hazard warnings on the rear of the central unit



The label shown on the left is attached to the rear of the central unit. The symbols on this label have the following meaning:



This symbol is intended to alert the user to the presence of uninsulated dangerous voltage within the central unit's enclosure that may be of sufficient magnitude to constitute risk of fire or electric shock.



This symbol is intended to alert the user to the risk of electric shock if the central unit is opened. There are no user serviceable parts inside. Refer servicing to qualified personnel only.



This symbol is intended to alert the user to the presence of important operating and maintenance instructions in the literature accompanying this product.

### Overloading

Do not overload wall outlets and extension cords as this may result in fire and electric shock.

### Safety check

Upon completion of any service or repairs to this device, ask the service technician to perform safety checks to determine that the device is in safe operating order.

### Danger of hearing damage due to high volumes

When the conference participants listen to the floor channel via headphones, they can adjust the volume themselves. In doing so, sound pressure exceeding 85 dB(A) can be produced. 85 dB(A) is the sound pressure corresponding to the maximum permissible volume which is by law (in some countries) allowed to affect your hearing for the duration of a working day. It is used as a basis according to the specifications of industrial medicine. Higher volumes or longer durations can damage your hearing. At higher volumes, the duration must be shortened in order to prevent hearing damage. The following are sure signs that you have been subjected to excessive noise for too long a time:

- You can hear ringing or whistling sounds in your ears.
- You have the impression (even for a short time only) that you can no longer hear high notes.

Inform the conference participants about these facts and, if necessary, ask them to set the volume to a medium level.

### Intended use

Intended use of the products includes:

- having read this instruction manual, especially the chapter "Important safety instructions",
- using the products within the operating conditions and limitations described in this instruction manual.

"Improper use" means using the products other than as described in this instruction manual, or under operating conditions which differ from those described herein.

## The Sennheiser ADN conference system

Sennheiser ADN stands for Sennheiser Audio Distribution Network – the new generation of digital conference equipment:

- Ideal for small to medium size conferences with approx. 30 participants
- High-quality audio signal due quality microphone and built-in loudspeakers
- Attractive design – fits into modern or traditional style conference rooms
- Guaranteed operational reliability due to state-of-the-art transmission technology
- Can be adapted quickly and easily to different room sizes and participant numbers
- Intuitive configuration and control of the conference system via the operating menu or the integrated software package

## Available system components – scope of delivery

The following ADN system components are available:

<a href="#">Central unit (Cat. No.: 502757)</a>	<ul style="list-style-type: none"><li>1 ADN CU1 central unit</li><li>1 quick guide</li><li>1 CD ROM (including, among other things, the “Conference Manager” software (Windows) and the instruction manual for the overall conference system as PDF)</li></ul>
<a href="#">Mains cable for central unit</a>	available in EU, UK and US versions, length 1.8 m (see “Accessories” on page 108)
<a href="#">Delegate unit (Cat. No.: 502758)</a>	<ul style="list-style-type: none"><li>1 ADN D1 delegate unit</li><li>1 quick guide</li></ul>
<a href="#">Chairman unit (Cat. No.: 502759)</a>	<ul style="list-style-type: none"><li>1 ADN C1 chairman unit</li><li>1 quick guide</li></ul>
<a href="#">System cable</a>	SDC CBL RJ-45, available in different lengths (see “Accessories” on page 108)

# Overview of the components

For conferencing, you require:

- 1 ADN CU1 central unit
- ADN D1 delegate units
- ADN C1 chairman units (optional, for granting speaking privileges)
- SDC CBL RJ-45 system cables (available in different lengths)
- "Conference Manager" software for configuring and controlling conferences (optional)
  - can be run on the central unit (a screen, keyboard, and mouse are required)
  - or
  - can be run on a separate Windows PC with Ethernet connection

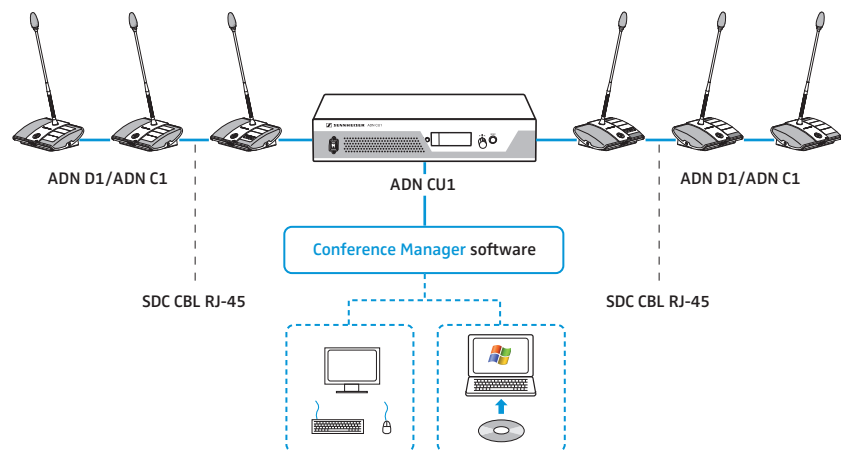





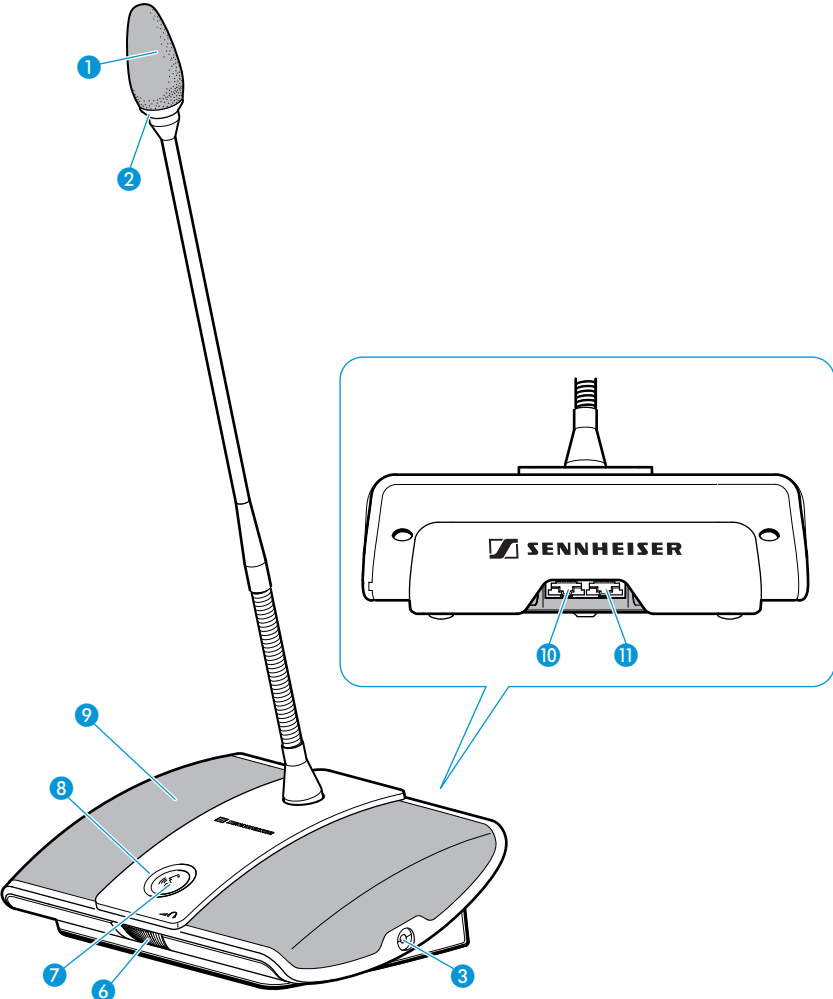

### ADN D1 delegate unit

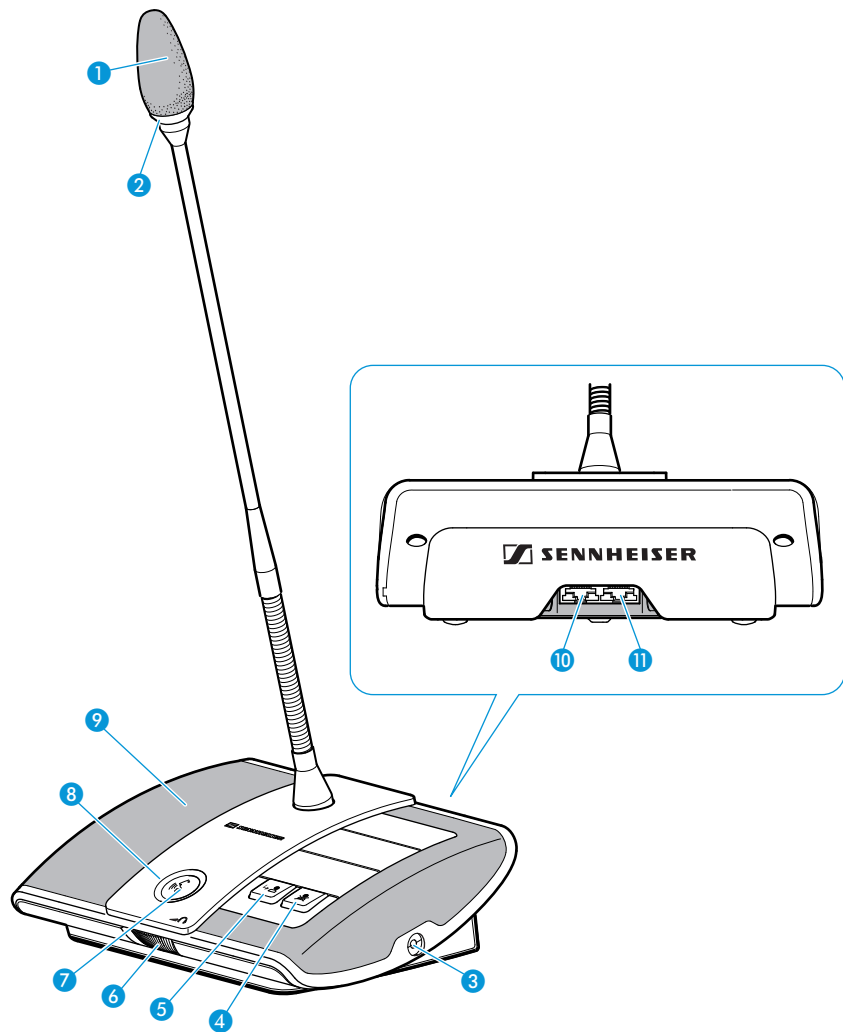

- 1 Sound inlet basket with firmly fixed windshield
- 2 Signal light ring
- 3 Headphone socket
- 4 Microphone key
- 5 Microphone LED
- 6 Loudspeaker
- 7 IN socket
- 8 OUT socket
- 9
- 10 IN socket
- 11 OUT socket

## ADN C1 chairman unit





- 1 Sound inlet basket with firmly fixed windshield
- 2 Signal light ring
- 3 Headphone socket
- 4 Priority key 
- 5 Next key 
- 6 Headphone volume control for headphone socket
- 7 Microphone key 
- 8 Microphone LED
- 9 Loudspeaker
- 10 IN socket
- 11 OUT socket

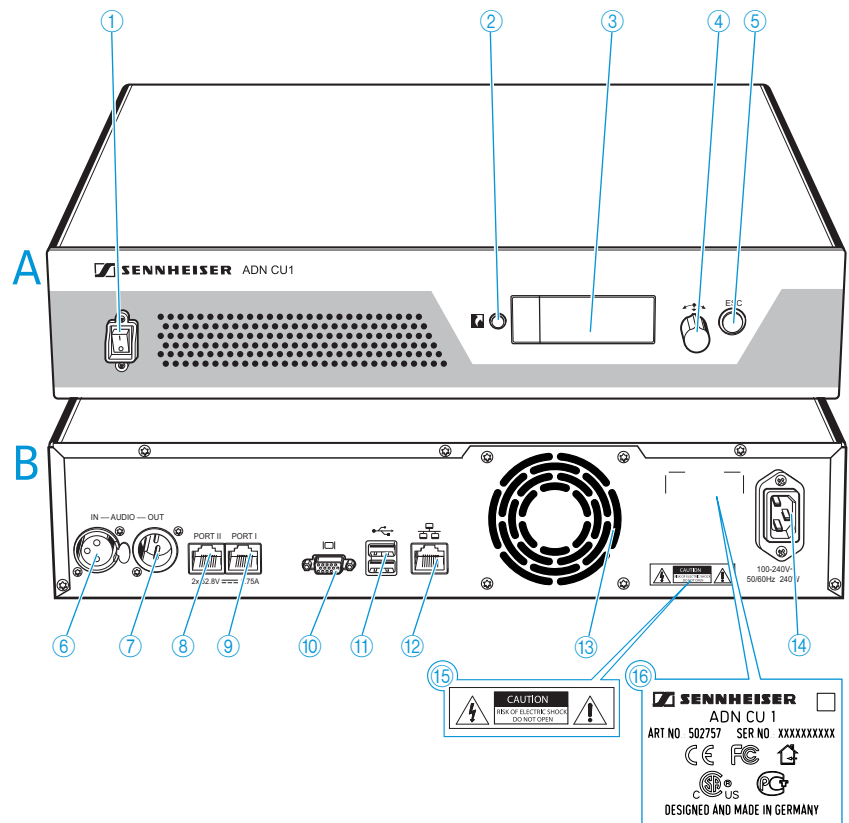

## ADN CU1 central unit



### A Front view

- ① On/off switch
- ② Standard display key 
- ③ Display panel
- ④ Jog dial 
- ⑤ ESC key (Escape)

### B Rear view

- ⑥ IN audio input
- ⑦ OUT audio output
- ⑧ PORT II socket (RJ 45) for connection of conference units
- ⑨ PORT I socket (RJ 45) for connection of conference units
- ⑩ VGA monitor output 
- ⑪ USB socket  (2x)
- ⑫ Network socket (RJ 45) 
- ⑬ Fans
- ⑭ Mains socket
- ⑮ Hazard warnings
- ⑯ Type plate

## Overview of the ADN CU1 display panel

After switch-on, the central unit's display shows a progress bar for approx. 30 seconds and then the standard display:

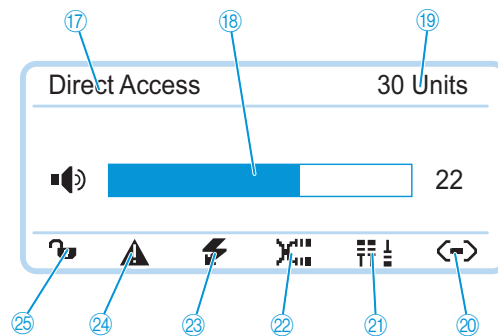

Text/icon	Possible display/function
<b>17</b> Conference mode	Current conference mode: "Direct Access", "Override", "Request"
<b>18</b> Floor channel volume	Current volume setting for the conference units' built-in loudspeakers
<b>19</b> Number of conference units	Number of connected conference units
<b>20</b> Connection status	↔: "Conference Manager" software is not connected to the central unit ↔: "Conference Manager" software is connected to the central unit
<b>21</b> Structural change icon	Icon appears if, since the last initialization, a malfunction/change has occurred in the wiring of the conference units (see page 34)
<b>22</b> Cable fault icon	Icon appears if conference units are not correctly connected (see page 34)
<b>23</b> Short-circuit icon	Icon appears if there is a short circuit in the wiring of the conference units (see page 34). The display panel lights up red.
<b>24</b> Warning triangle	Icon appears if there is a malfunction/change (see page 34). The display panel lights up red.
<b>25</b> Lock mode icon (see page 21)	Lock mode of the central unit: 🔓: Lock mode is deactivated 🔒: Lock mode is activated

## The “Conference Manager” software

The “Conference Manager” software allows you to conveniently configure and control the entire conference via a Windows PC or directly via the central unit.

For further information on the software, refer to the chapter “Using the “Conference Manager” software” on page 49.

## The SDC CBL RJ-45 system cables

The system cables transmit the digital audio and status information and supply power to the conference units.

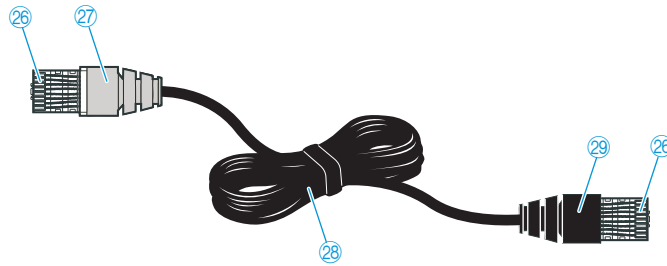

- ②⑥ Shielded RJ 45 modular plug, cat 5(e)
- ②⑦ Gray cable booth with clip protector
- ②⑧ Round STP cable, cat 5(e), 24 AWG, black
- ②⑨ Black cable booth with clip protector

# Structuring and controlling the conference system

## Structuring the conference system

The ADN conference system is suitable for small to medium size conferences with approx. 30 conference units (divided up onto the two connection sockets **PORT I** and **PORT II**). Delegate units and chairman units can be combined in an arbitrary order and are connected to the central unit using SDC CBL RJ-45 system cables. The ends of the cable strings are open (no ring topology). The maximum number of conference units that can be used depends on the voltage supply which in turn is influenced by the cable lengths (see next chapter).

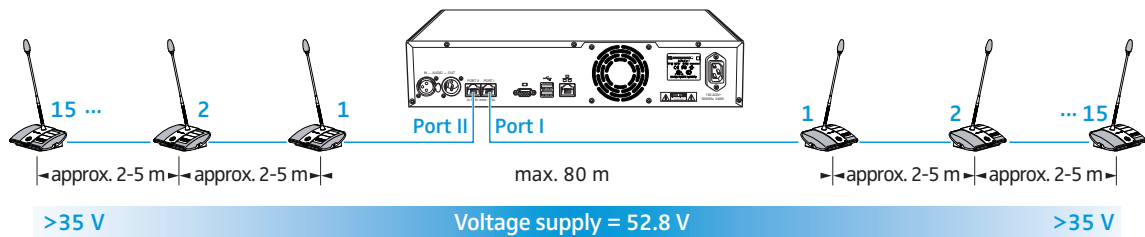

In addition, you can connect audio devices to the central unit in order to e.g. feed audio signals to the floor channel or to output the floor channel via an external audio device.

## Calculating the voltage drop on the system cables

For safe operation of the conference system, make sure that all conference units are supplied with a voltage of at least 35 V! The voltage supplied depends on the number of connected conference units and on the cable lengths. The standard cable length between the central unit and the first conference unit is 80 m max. and the standard cable length between the conference units is 2-5 m. If these cable lengths are observed, safe operation of a conference system with 30 conference units is ensured. If cable lengths are shorter, it might be that more conference units can be used.

The "ADN Cable Calculator" program allows you to calculate the voltage drops on the individual sections of a cable string and to plan the structure of the conference system. The program is available from your Sennheiser partner or from the download area on our website at [www.sennheiser.com](http://www.sennheiser.com).

To use the "ADN Cable Calculator" program:

- ▶ Start the "ADN Cable Calculator.exe" file and follow the instructions of the program.

For further information and for how to calculate the voltage drop of a cable string, refer to the help of the "ADN Cable Calculator" program.

Configuring and controlling the conference system

For configuring the conference system, you can either use the operating menu of the central unit or the "Conference Manager" software. The software also allows you to control conferences via a graphical interface:

Function	Operating menu	"Conference Manager" software
Configuring the conference	✓	✓
Controlling the conference via a graphical interface	✗	✓

The "Conference Manager" software can be run in two different ways:

- a) As a program on the central unit's built-in PC.  
You have to connect a screen, keyboard, and mouse to the central unit (see page 50).
- b) As a program on a Windows PC.  
You have to install the "Conference Manager" software on the PC and integrate the PC together with the central unit in a network (see page 50).

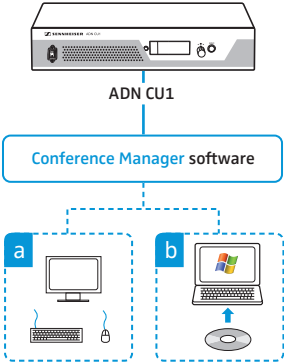

# Putting the conference system into operation

## Preparing the central unit for use

### Setting up the central unit on a flat surface or mounting it into a rack

If you want to place the central unit **on a flat surface**:

- ▶ Make sure that the air vents are not covered or blocked.
- ▶ Place the central unit on a flat surface as shown.

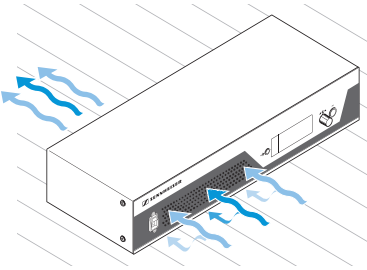

If you want to mount the central unit **into a 19" rack**, the central unit must be supported and fixed to the rack using additional components.

**CAUTION** Danger of material damage and personal injury when rack mounting the central unit!



When installing the product in a closed or multi-rack assembly, please consider that, during operation,

- the ambient temperature within the rack may drastically increase,
- high mechanical loading may occur,
- intrinsically harmless leakage currents of the individual mains units may accumulate, thereby exceeding the allowable limit value.

This can cause material damage and electric shocks.

- ▶ **Always** mount the central unit using a suitable rack tray. Make sure that the mechanical loading of the rack is even.
- ▶ Make sure that the ambient temperature within the rack does not exceed the permissible temperature limit specified in the specifications (see page 109). Ensure sufficient ventilation; if necessary, provide additional ventilation.
- ▶ When connecting to the power supply, observe the information indicated on the type plate. Avoid circuit overloading. If necessary, provide overcurrent protection.
- ▶ Ground the rack via an additional ground connection.

### Fastening the optional rack mount "ears"

- ▶ Unscrew and remove the 2 torx screws (T25) on each side of the central unit (see left-hand diagram).
- ▶ Secure the optional rack mount "ears" ③① (see "Accessories" on page 108) to the sides of the central unit using the previously removed torx screws (see right-hand diagram).

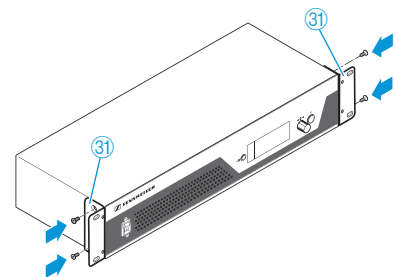
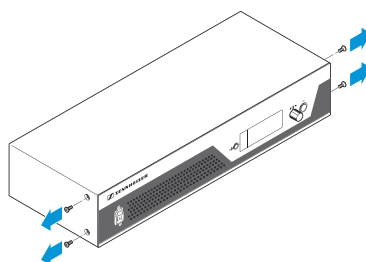



- ▶ Slide the central unit with the mounted rack mount “ears” into the 19” rack and support the weight with e.g. a rack tray.
- ▶ Secure the rack mount “ears” to the rack.



An engineering drawing detailing the dimensions of the central unit can be found in the appendix (see page 111).

### Connecting the central unit to the mains

---

**CAUTION** Product damage due to unsuitable mains cables or power outlets!

An unsuitable power supply can damage the product.

- ▶ Only use the recommended mains cable (see “Accessories” on page 108) for connecting the product to the mains.
  - ▶ Only use multi-outlet power strips or extension cables with protective ground contacts.
  - ▶ Only use mains cables with a 3-pin connector.
- 

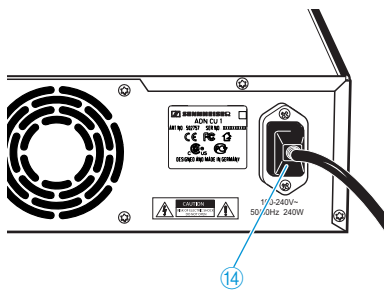

- ▶ First connect the mains cable to the mains socket ⑭.
- ▶ Connect the mains cable to the mains.  
The central unit is now ready for operation.

### Preparing the conference units for use

The conference units are ready for operation upon delivery. The conference system automatically recognizes if the connected conference units are chairman units or delegate units and initializes them automatically.



If you connect chairman units to the conference system during a running conference, you have to re-initialize them (see page 30 or page 88).

## Setting up the conference system

### Installing the cable holder

If you want to permanently install your conference system in a room, use the optional cable holders (see "Accessories" on page 108).

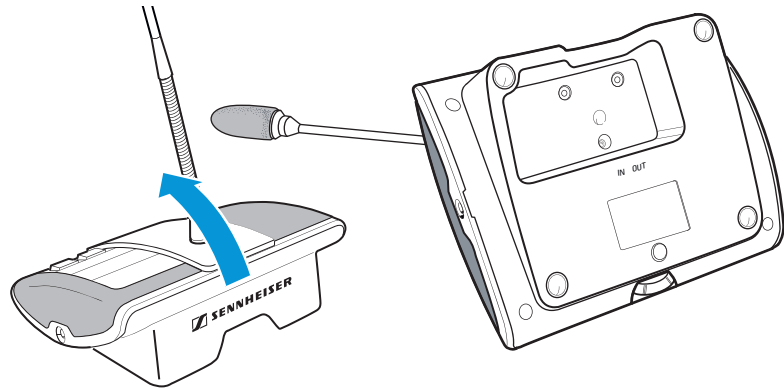

- ▶ Tilt the conference units as shown.
- ▶ Hold the conference units with one hand so that the microphone does not rest on the table.

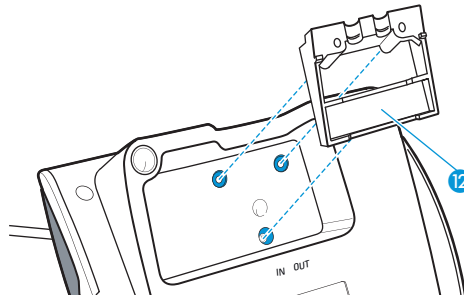

- ▶ Insert the cable holder 12 as shown. At this point, the cable holder 12 is **not yet** fixed with screws. You first have to connect the conference units as described in the following chapter.

### Connecting the conference units to the central unit

You can connect up to 15 conference units to each of the central unit's connection sockets **PORT II** 8 or **PORT I** 9. The maximum number of conference units that can be used in one cable string depends on the overall cable length connected to a port (see page 13).

The following describes the procedure for one cable string. If necessary, repeat these steps for a second cable string.

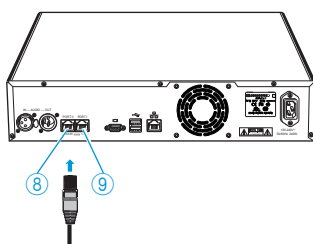

- ▶ Place the conference units at the corresponding seats.
- ▶ Put out a sufficient number of system cables in the required lengths (see "Accessories" on page 108).
- ▶ If necessary, calculate the maximum length of the cable string in order to ensure that all conference units connected in the string are supplied with a voltage of at least 35 V (see page 13).

If you are using cable holders (see previous chapter):

- ▶ Choose a suitable cover **13** for the cable holder **12**:

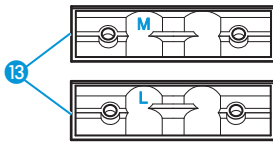

Cable	Cable holder cover
SDC CBL RJ 45 system cable	marked "M"
Highly shielded cable	marked "L"

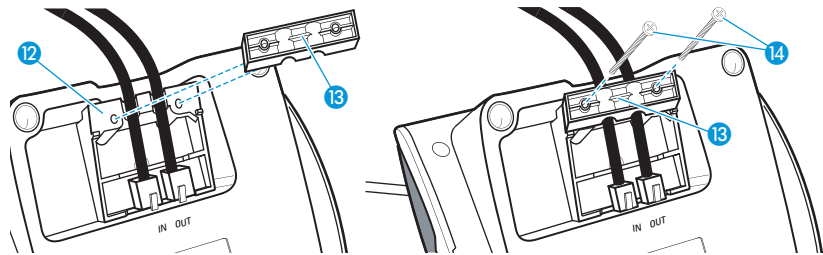

- ▶ Affix the covers **13** as shown.
- ▶ Slightly tighten the supplied screws **14** (approx. 0.05 Nm).

To connect the conference units to the central unit:

**CAUTION** Product damage due to an unsuitable power supply!

An unsuitable power supply can damage network devices with RJ 45 plugs that are connected to the connection sockets **PORT I** and **PORT II**.

- ▶ Only connect ADN C1 and ADN D1 conference units to the connection sockets **PORT I** and **PORT II**.

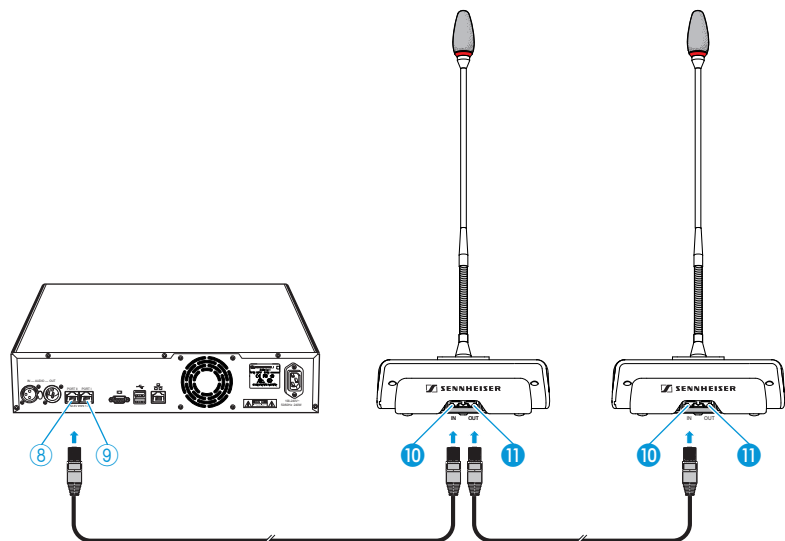

- ▶ Use a system cable to connect the **IN** socket **10** of the first conference unit to the **PORT II** socket **8** or **PORT I** socket **9** of the central unit (see above).
- ▶ Use a system cable to connect the **OUT** socket **11** of the first conference unit to the **IN** socket **10** of the second conference unit.
- ▶ Repeat these steps for the remaining conference units.



Please note that there is a limited number of approx. 15 conference units per cable string due to the voltage drop on the cable string (see page 13).

### Connecting external audio devices to the central unit

To output the floor channel via an external audio device:

- ▶ Use an XLR cable to connect the **OUT** audio output ⑦ of the central unit to an external audio device.

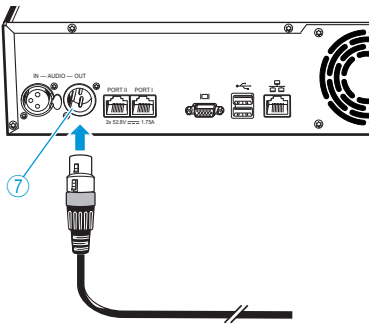

To connect an external audio source and to feed its signals to the floor channel:

- ▶ Use an XLR cable to connect the external audio source to the **IN** audio input ⑥ of the central unit.

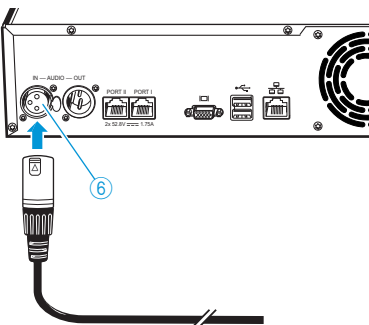

### Running the software installed on the central unit

To use the "Conference Manager" software installed on the central unit, you require the following devices:

Device	Requirements
Screen	Connection: 15-pin Sub-D VGA Resolution: 800 x 600 pixels or higher Recommended: 1024 x 768 or 1280 x 1024 pixels
Mouse	Standard USB for Windows PCs
Keyboard	Standard USB for Windows PCs Supported language layouts: e.g. English, German, French, Spanish, Italian, Russian, Dutch (for the complete list, see "Keyboard layouts" on page 112)

- ▶ Use a Sub-D VGA cable to connect a screen to the VGA monitor output ⑩.

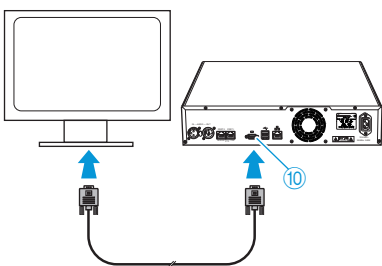

- ▶ Connect the keyboard and the mouse to the two USB sockets ⑪.
- ▶ Configure the screen, keyboard and mouse settings using the "Conference Manager" software (see page 63).  
Your conference system is now ready for operation.

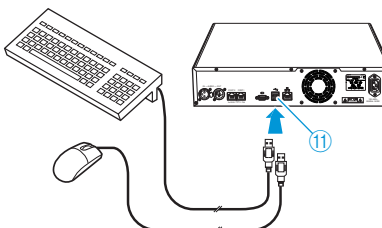

The USB sockets only support a keyboard and a mouse.

### Running the software on a separate Windows PC

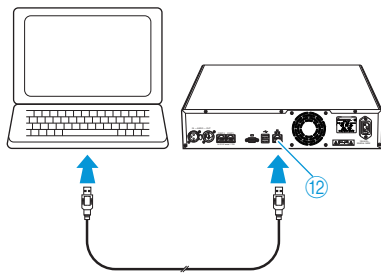

To run the "Conference Manager" software on a separate Windows PC, the PC must meet the system requirements listed on page 50.

- ▶ Use a network cable (Cat5) to connect the Ethernet socket ⑫ of the central unit to the network interface of your PC.



You can also connect the PC and the central unit using a switch or similar.

- ▶ Install the "Conference Manager" software supplied on the CD ROM on your connected PC (see page 51).
- ▶ Configure the network as described in the chapter "Preparing the Windows version of the software for use" on page 50.

## Switching the conference system on/off

To switch the conference system on:

- ▶ Set the on/off switch ① to position "I".  
The central unit switches on and its display panel lights up.

To switch the conference system off:



If you have made changes to a configuration using the "Conference Manager" software, you have to save these changes before switching the central unit off (see page 69). All other settings of the central unit are automatically saved.

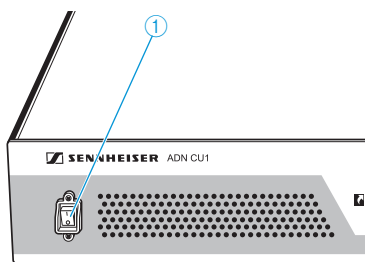

- ▶ Set the on/off switch ① to position "0".  
The central unit is switched off completely.







# Using the central unit

## Deactivating the lock mode of the central unit

If the lock mode is activated (see page 43), you have to deactivate it in order to be able to operate the central unit:

-  ▶ Press the jog dial or any other key.  
"Lock" appears on the display panel.
-  ▶ Turn the jog dial.  
The "OFF" setting is selected.
-  ▶ Press the jog dial.  
The lock mode is deactivated.



## Functions of the keys

Action	Functions
Press the ESC key 	<ul style="list-style-type: none"> <li>• Cancels the entry and returns to the next higher menu level or to the standard display</li> </ul>
Press the jog dial 	<ul style="list-style-type: none"> <li>• Changes from the standard display to the operating menu</li> <li>• Calls up a menu item</li> <li>• Enters a submenu</li> <li>• Stores the settings and returns to the operating menu</li> </ul>
Turn the jog dial 	<ul style="list-style-type: none"> <li>• Increases or reduces the floor channel volume (when the standard display is shown)</li> <li>• Changes to the next/previous menu item</li> <li>• Changes the setting of a menu item</li> </ul>
Press the standard display key 	<ul style="list-style-type: none"> <li>• Returns to the standard display</li> </ul>

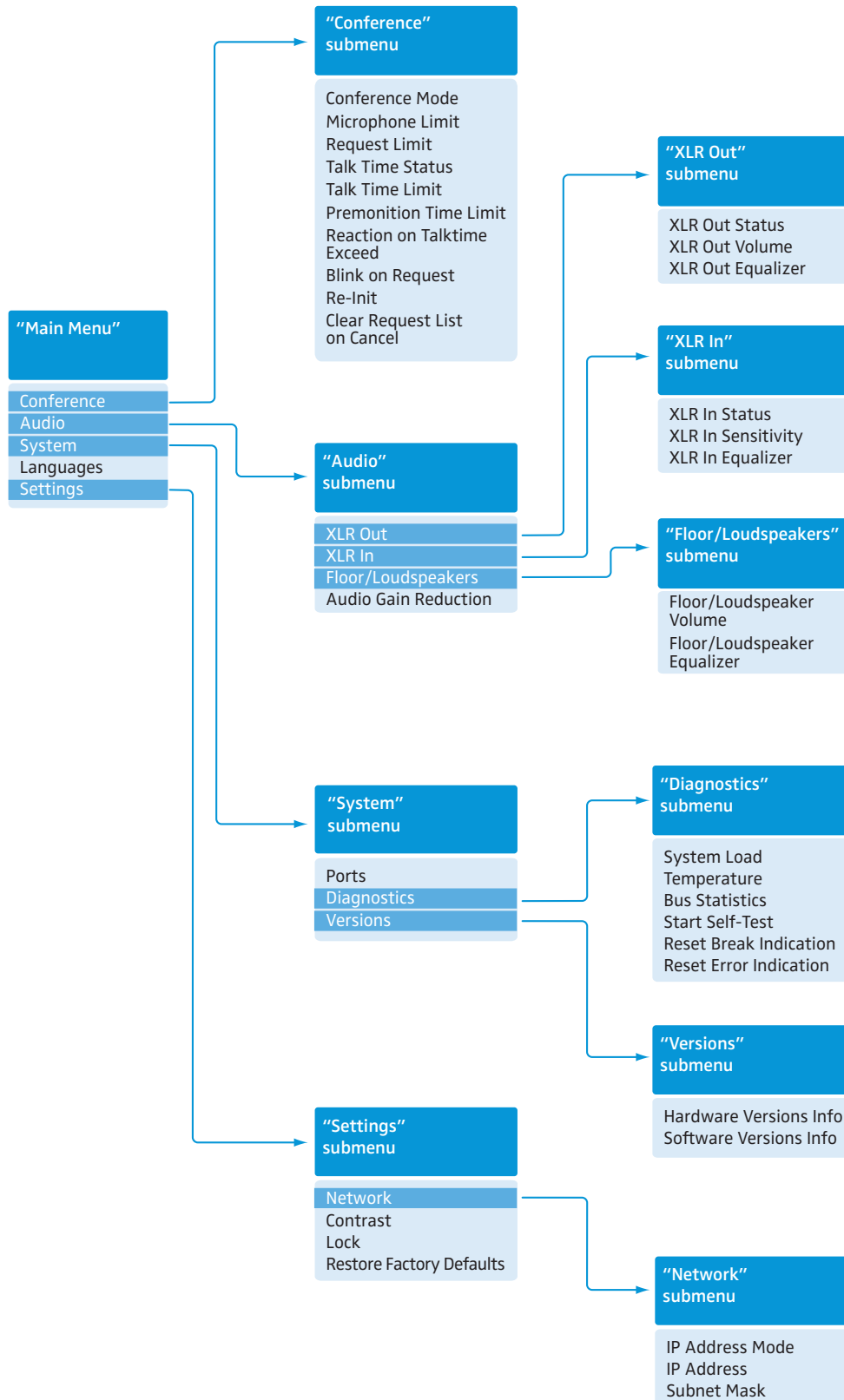

# Configuring the conference system via the central unit

## Overview of the operating menu



Display	Function of the menu item	Option/display	Page
<b>"Main Menu"</b>			
"Conference"	Calls up the "Conference" submenu	–	26
"Audio"	Calls up the "Audio" submenu	–	31
"System"	Calls up the "System" submenu	–	34
"Languages"	Adjusts the language	"Deutsch", "English", "Español"...	41
"Settings"	Calls up the "Settings" submenu	–	
<b>"Conference" menu</b>			
"Conference Mode"	Adjusts the conference mode	"Direct Access", "Override" or "Request"	26
"Microphone Limit"	Sets the maximum number of speakers who can take the floor simultaneously in "Direct Access" and "Override" mode	"1" ... "10"	27
"Request Limit"	Sets the maximum number of requests to speak in "Request" and "Direct Access" mode	"0" ... "10"	28
"Talk Time Status"	Activates/deactivates the speaking time limit	"On"/"Off"	28
"Talk Time Limit"	Sets the speaking time limit	"01" ... "60" in steps of 1 minute	28
"Premonition Time Limit"	Sets the advance warning time (warns speakers that they are approaching the end of the individual speaking time)	"00" ... "120" in steps of 10 seconds	28
"Reaction on Talktime Exceed"	Determines the behavior when the individual speaking time is exceeded	"Continue"/"Cancel"	29
"Blink on Request"	Activates/deactivates the flashing of the signal light ring when a request to speak is made	"On"/"Off"	30
"Re-Init"	Re-initializes the conference units	"Yes"/"No"	30
"Clear Request List on Cancel"	Sets the function of the priority key  of the chairman unit	"On"/"Off"	30
<b>"Audio" menu</b>			
"XLR Out"	Calls up the "XLR Out" submenu	–	31
"XLR In"	Calls up the "XLR In" submenu	–	
"Floor/Loudspeakers"	Calls up the "Floor/Loudspeakers" submenu	–	
"Audio Gain Reduction"	The sum signal of all active conference units is output via the floor channel ("Floor/Loudspeakers"). The "Audio Gain Reduction" menu item allows you to adjust how the volume levels of the signals of the individual conference units are processed.	"0.0 dB per Mic" ... "–3.0 dB per Mic", "Linear Division"	32
<b>"XLR Out" menu</b>			
"XLR Out Status"	Activates/deactivates the OUT audio output	"On"/"Off"	31
"XLR Out Volume"	Adjusts the volume of the XLR output	 "01" ... "32"	
"XLR Out Equalizer"	Adjusts the tone color of the XLR output	 +02 dB –03 dB +05 dB "–12 dB" ... "+12 dB"	

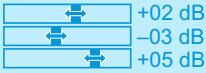

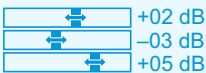
Display	Function of the menu item	Option/display	Page
<b>"XLR In" menu</b>			
"XLR In Status"	Activates/deactivates the IN audio input	"On"/"Off"	31
"XLR In Sensitivity"	Adjusts the sensitivity of the XLR input	..... — "–18.0 dBu" ... "+18.0 dBu"	
"XLR In Equalizer"	Adjusts the tone color of the XLR input	 "–12 dB" ... "+12 dB"	
<b>"Floor/Loudspeakers" menu</b>			
"Floor/Loudspeakers Volume"	Adjusts the floor channel volume ("Floor/Loudspeakers")	 "00" ... "32"	32
"Floor/Loudspeakers Equalizer"	Adjusts the tone color of the floor channel	 "–12 dB" ... "+12 dB"	
<b>"System" menu</b>			
"Ports"	Displays the type and number of the conference units connected to <a href="#">Port I</a> and <a href="#">Port II</a>	Deleg Chair. Port1: xx xx Units Port2: xx xx Units	37
"Diagnostics"	Calls up the "Diagnostics" submenu	–	38
"Versions"	Calls up the "Versions" submenu	–	41
<b>"Diagnostics" menu</b>			
"System Load"	Provides information on the current and voltage supply	Current Voltage Port1 ☺ ☹ Port2 ☺ ☺	38
"Temperature"	Provides information on the temperature status	Status ☺	39
"Bus Statistics"	Provides information on the status of data transmission/errors	Error Indication : ☺ Break Count : 1	39
"Start Self-Test"	Performs a self-test on the conference system	"On"/"Off"	40
"Reset Break Indication"	Resets the error counter ("Break Count") in the "Bus Statistic" menu item	"Yes"/"No"	40
"Reset Error Indication"	Resets the display for data bus errors ("Error Indication") in the "Bus Statistic" menu item	"Yes"/"No"	40
<b>"Versions" menu</b>			
"Hardware Version Info"	Displays the hardware version	DU/PU: 1 CU SB: 1	41
"Software Version Info"	Displays the software version	DU/PU: 0.1.1.5 CU SB: 1.0.0.0 CU Main: 1.0.0.1	41

Display	Function of the menu item	Option/display	Page
<b>"Settings" menu</b>			
"Network"	Calls up the "Network" submenu	–	42
"Contrast"	Adjusts the contrast of the display panel	"1" ... "15"	42
"Lock"	Activates/deactivates the lock mode	"On"/"Off"	43
"Restore Factory Defaults"	Restores the factory default settings	"Yes"/"No"	43
<b>"Network" menu</b>			
"IP Address Mode"	Sets the IP address allocation mode	"Static IP"/"Dynamic IP"	42
"IP Address"	Sets the IP address of the central unit	"xxx . xxx . xxx . xxx"	42
"Subnet Mask"	Sets the subnet mask of the central unit	"xxx . xxx . xxx . xxx"	42

## Working with the operating menu

By way of example of the "Microphone Limit" menu item, this section describes how to use the operating menu.

Information on the factory default settings of the operating menu can be found in the appendix (see page 111).

### Changing from the standard display to the operating menu

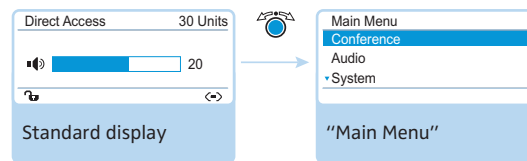

- ▶ Press the jog dial. The standard display is replaced by the main menu. The last selected menu item is highlighted.

### Calling up a menu item

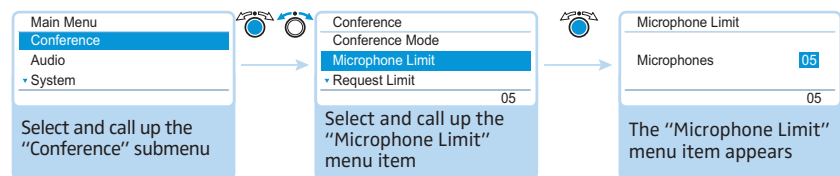

- ▶ Press the jog dial to call up the "Conference" menu item. The "Conference" submenu appears.
- ▶ Turn the jog dial to select the "Microphone Limit" menu item.
- ▶ Press the jog dial to call up the "Microphone Limit" menu item.

### Changing and storing settings

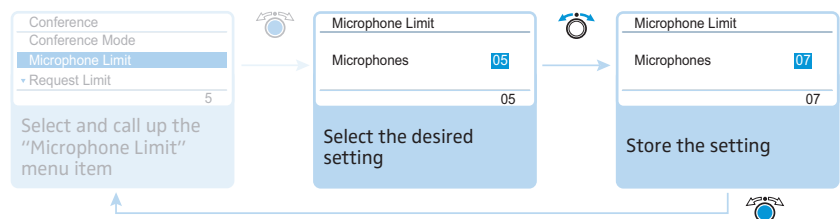

- ▶ Turn the jog dial to adjust settings in the "Microphone Limit" menu item.

- ▶ Press the jog dial.  
Your setting is stored. You are back to the operating menu.



By briefly turning the jog dial to the left or right, the next or the previous menu item or setting is displayed.

If you turn the jog dial to the left or right and hold it in this position, the menu items or settings change in quick succession (“fast search” function).

### Canceling an entry



- ▶ Press the **ESC** key.  
The operating menu or the next higher menu level appears.

Or:



- ▶ Press the standard display key.  
The standard display appears.

To subsequently directly return to the last edited menu item:



- ▶ Press the jog dial repeatedly until the last edited menu item appears.

### Exiting the operating menu



- ▶ Press the standard display key.  
The standard display appears.

Or:



- ▶ Press the **ESC** key repeatedly until the standard display appears.

## Adjusting the conference settings – “Conference”

The settings available in the “Conference” menu item affect the behavior of the entire conference system during a conference.

### CAUTION Interruption of a running conference

If you adjust settings in the “Conference” menu item during a running conference, the conference will be interrupted.

- ▶ Inform the participants that the conference settings are being changed and that they might have to make a new request to speak.

### Adjusting the conference mode – “Conference Mode”

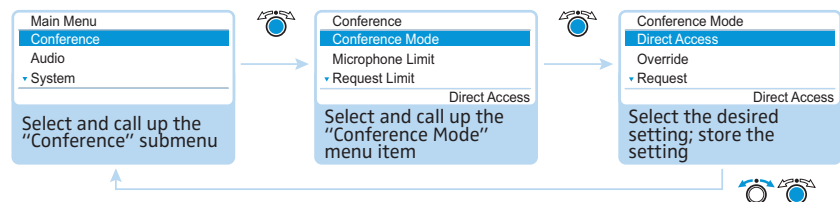

Possible settings: “Direct Access”, “Override” and “Request”.

- “Direct Access” mode and “Override” mode:  
These two conference modes do not require the use of a chairman unit.

If the maximum number of speakers who can take the floor simultaneously (“Microphone Limit”) has not been reached, a further speaker can take the floor immediately.

<b>Situation</b>	The maximum number of speakers who can take the floor simultaneously (“Microphone Limit”) has been reached.
<b>Event</b>	A further speaker presses the microphone key on his or her conference unit.
<b>Behavior</b>	In “Direct Access” mode: The speaker has to wait until one of the current speakers passes on or loses his or her speaking privileges. He is then automatically granted speaking privileges.  In “Override” mode: The speaker can take the floor immediately. The speaker with the longest speaking time loses his or her speaking privileges.

- “Request” mode:

For this mode to function, a chairman unit is required.

In “Request” mode, the chairman receives requests to speak and grants speaking privileges according to the FIFO principle (First In – First Out), i.e. the speaker with the longest waiting time is granted speaking privileges.

<b>Situation</b>	The maximum number of requests to speak has been reached (“Request Limit”).
<b>Event</b>	A further speaker makes a request to speak.
<b>Behavior</b>	The speaker can only make a request to speak if the maximum number of requests to speak drops below the specified limit value.

### Setting the max. number of speakers who can take the floor simultaneously – “Microphone Limit”

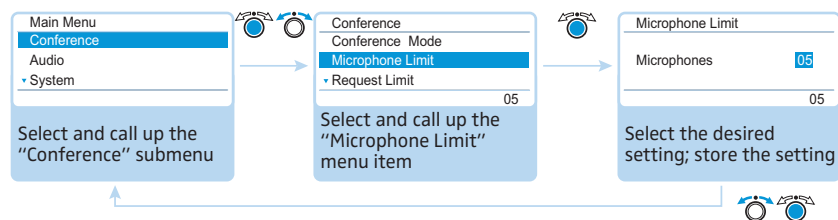

Adjustment range: “1” ... “10”

The “Microphone Limit” menu item allows you to set the max. number of speakers who can take the floor simultaneously in all conference modes. Please note that any connected chairman unit is counted against the microphone limit. If you set a higher value (adjustment range “1” ... “10”) than the one determined by the number of connected chairman units, the system will reduce the microphone limit to the maximum possible value (see examples in the table).

Chairman units	Possible “Microphone Limit” values
0	“1” - “10”
4	“1” - “5”
10	“0”

For information on how this setting affects your conference, refer to the previous section “Adjusting the conference mode – “Conference Mode””.

### Setting the maximum number of requests to speak – “Request Limit”

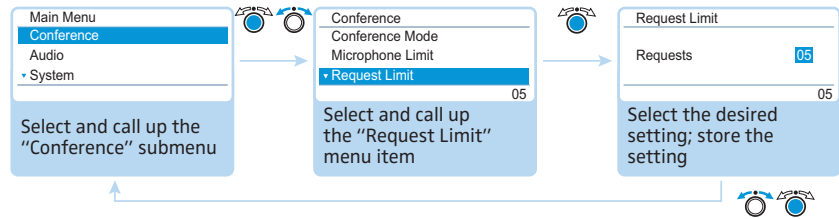

Adjustment range: “0” ... “10”

The setting adjusted in the “Request Limit” menu item becomes effective only if you are using a chairman unit (“Request” mode) or if you have selected “Direct Access” mode.

For information on how this setting affects your conference, refer to the section “Adjusting the conference mode – “Conference Mode”” on page 26.

### Activating/deactivating the speaking time limit – “Talk Time Status”

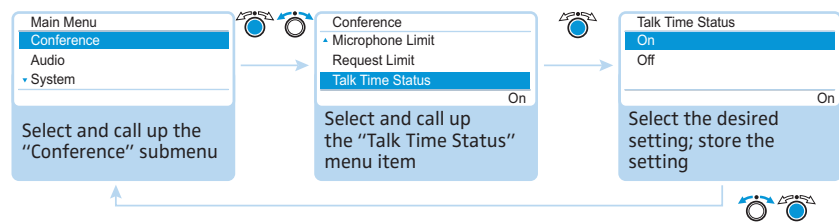

Possible settings: “On” and “Off”

This menu item allows you activate/deactivate the speaking time limit. The duration of the speaking time limit, the advance warning time, and the behavior after expiration of the speaking time limit can be set in the following 3 menu items.

### Setting the speaking time limit– “Talk Time Limit”

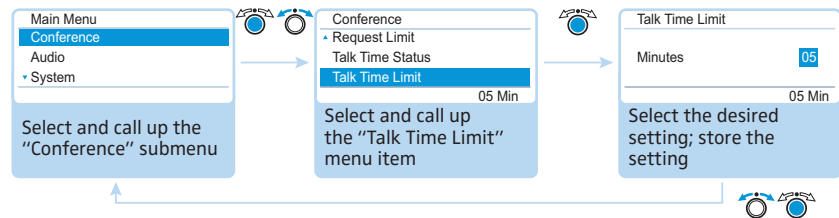

Adjustment range: “01” ... “60”, adjustable in steps of 1 minute

The speaking time limit becomes effective only if it is activated in the “Talk Time Status” menu item (see previous section).

Please note that the speaking time limit applies to each and every input to the discussion.

### Setting the advance warning time – “Premonition Time Limit”

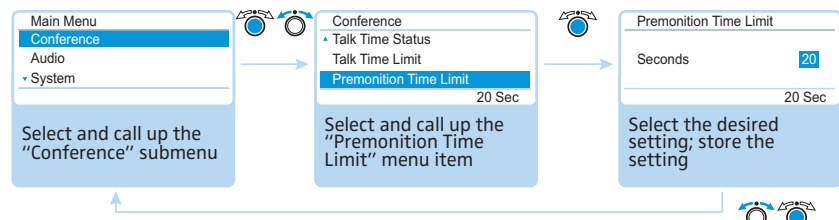

Adjustment range: “00” ... “120”, adjustable in steps of 10 seconds

- ▶ Set the advance warning time.  
This setting affects your conference as follows (example):

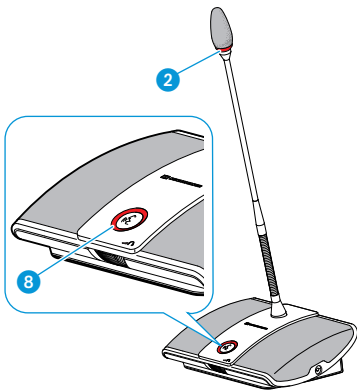

"Talk Time Limit" (speaking time limit)	15 (minutes)
"Premonition Time Limit" (advance warning time)	60 (seconds)
Effect	60 seconds before the speaking time limit expires, i.e. after 14 minutes in this example, the signal light ring 2 and the microphone LED 8 start flashing red.

Determining the behavior when the individual speaking time is exceeded – "Reaction on Talktime Exceed"

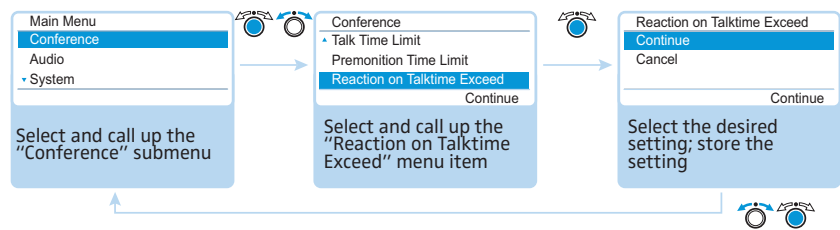

Possible settings: "Continue" and "Cancel"

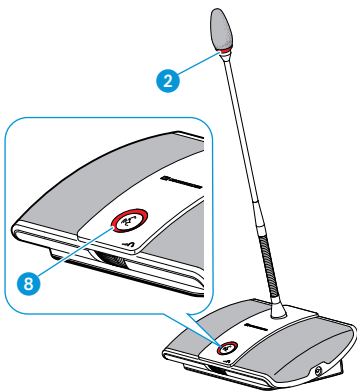

Event	The end of the individual speaking time is reached.
Behavior	<p>"Continue": The individual speaking time is continued. The signal light ring 2 and the microphone LED 8 flash red until the speaker has finished speaking.</p> <p>"Cancel": The individual speaking time is terminated. The signal light ring 2 and the microphone LED 8 go off.</p>

### Activating/deactivating the flashing of the signal light ring when a request to speak is made – “Blink on Request”

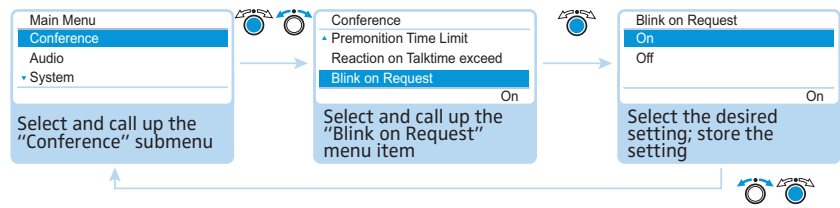

Possible settings: “On” and “Off”

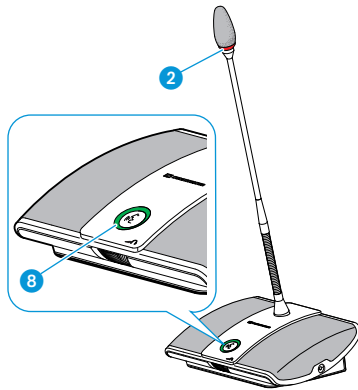

Setting	Behavior of the signal light ring
“On”	When a participant makes a request to speak, the microphone LED 8 flashes green and the signal light ring 2 flashes red. The participant him or herself sees the flashing microphone LED 8 whereas the other participants see the flashing signal light ring 2 which indicates that a request to speak has been made.
“Off”	When a participant makes a request to speak, the microphone LED 8 flashes green. All other participants cannot see that this participant has made a request to speak.

### Re-initializing the conference units – “Re-Init”

If you connect chairman units to the conference system during a running conference, you have to re-initialize them.

When conference units are re-initialized, the conference will be interrupted.

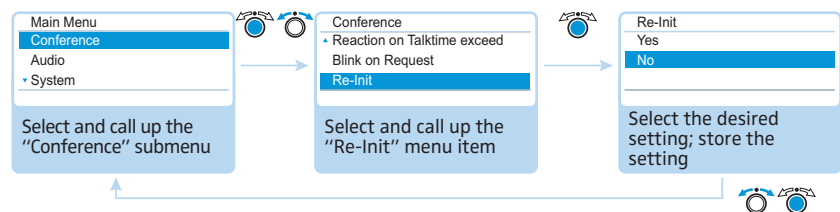

Possible settings: “Yes” and “No”

### Setting the function of the priority key 4 – “Clear Request List on Cancel”

This menu item allows you to set the function of the chairman unit’s priority key 4.

- Setting “On”: Pressing the priority key deactivates all delegate units. All requests to speak are deleted.
- Setting “Off”: Pressing the priority key deactivates all currently active delegate units. All requests to speak are retained.

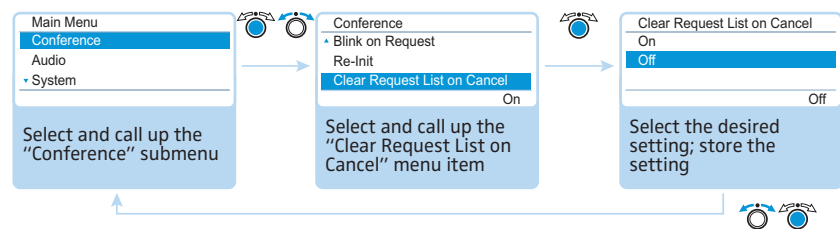
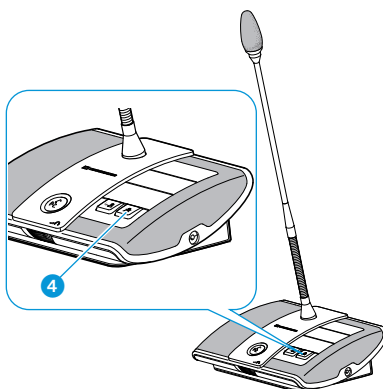

Possible settings: “On” and “Off”

## Adjusting the audio settings – “Audio”

The “Audio” submenu allows you to adjust settings that affect the audio signals of the conference system.

### Adjusting settings for the OUT audio output and the IN audio input – “XLR Out” and “XLR In”

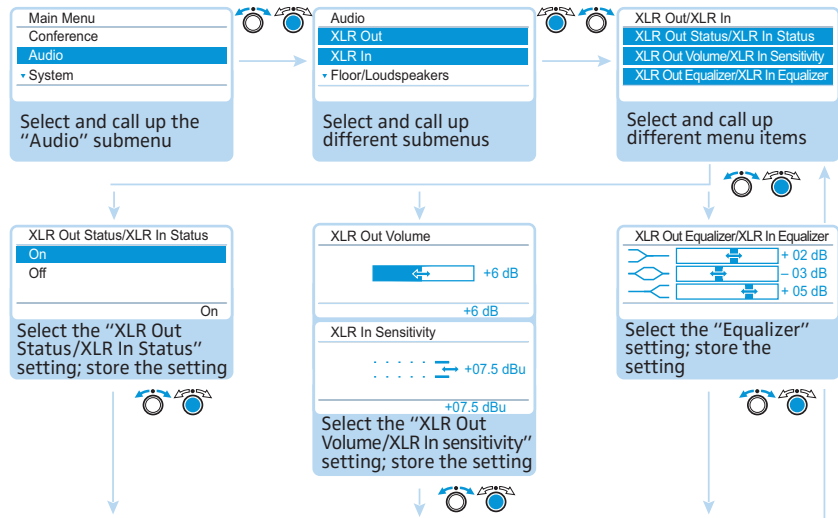

Submenu	Menu item	Function
“XLR Out”	“XLR Out Status”	Activates/deactivates the OUT audio output
	“XLR Out Volume”	Adjusts the volume of the OUT audio output
	“XLR Out Equalizer”	Adjusts the tone color
“XLR In”	“XLR In Status”	Activates/deactivates the IN audio input
	“XLR In Sensitivity”	Adjusts the sensitivity of the IN audio input (the current level is displayed). ▶ Adjust the sensitivity so that the level display shows an almost full deflection at maximum input volume.
	“XLR In Equalizer”	Adjusts the tone color



In the “Equalizer” menu item, you can change between the frequency ranges by pressing the jog dial ④.

Press the ESC key ⑤ to cancel your entry and restore the previous state of all frequency ranges.



### Adjusting settings for the floor channel – “Floor/Loudspeakers”

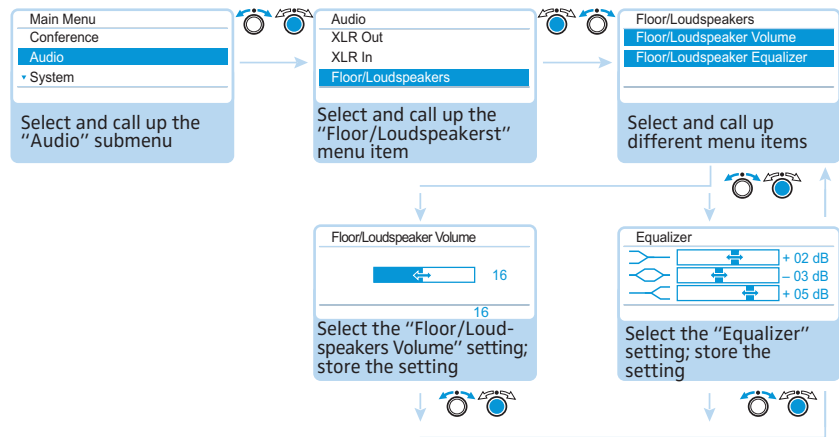

Menu item	Function
“Floor/Loudspeakers Volume”	Adjusts the floor channel volume
“Floor/Loudspeakers Equalizer”	Adjusts the tone color



In the “Equalizer” menu item, you can change between the frequency ranges by pressing the jog dial ④.

Press the ESC key ⑤ to cancel your entry and restore the previous state of all frequency ranges.

### Adjusting the processing of the conference units’ audio signals in the floor channel – “Audio Gain Reduction”

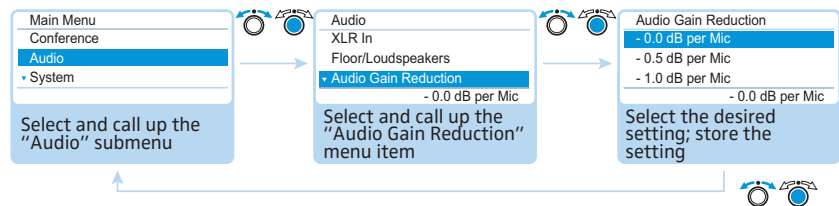

Possible settings: “0.0 dB per Mic” ... “-3.0 dB per Mic” and “Linear Division”

The sum of the audio signals of all conference units is fed to the floor channel (“Floor/Loudspeakers”) which in turn is output via the conference units’ built-in loudspeakers and via the OUT audio output. The volume level of the floor channel increases with each additional audio signal\* and tends to overmodulate. The “Audio Gain Reduction” menu item allows you to adjust how the volume levels of the signals of the conference units are processed.

<b>Situation</b>	The audio signal of the 1. conference unit is fed to the floor channel.
<b>Event</b>	The audio signal of another conference unit is fed to the floor channel. The volume level of the floor channel would increase if the signal wasn’t influenced.

\* conference units and IN audio input

**Behavior****“0.0 dB per Mic” ... “-3.0 dB per Mic” setting:**

With each additional audio signal, the volume level of the floor channel is reduced by the adjusted value.

- ▶ Try out the different settings by activating the maximum number of open channels (see page 45).  
The floor channel should be heard at the desired volume level without any distortion or feedback.
- ▶ First start with low values.

**“Linear Division” setting:**

The volume level of the floor channel is automatically reduced depending on the number of conference units (high gain reduction of the audio signal).

## Checking the system and detecting problems – “System”

The “System” submenu provides information on the current status of your conference system and any errors that have occurred.

After switch-on, the central unit automatically performs a self-test. If errors are detected during the self-test, the error icons 21 to 24 indicate the type of error encountered. When the error icons 23 to 24 appear, the display panel changes from orange to red.

The central unit also checks the conference system for errors during a running conference and, if necessary, shows the following icons to indicate these errors.

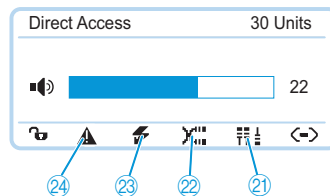

Icon	Meaning
	Warning triangle
	Short-circuit icon
	Cable fault icon
	Structural change icon

To ensure trouble-free operation of your conference system:

- ▶ Carry out the following steps **before** starting the conference. This allows you to diagnose and remedy errors in your conference system at an early stage.
- ▶ Set up your entire conference system. If you do not yet know the final number of participants, take the maximum number of participants as a starting point. Connect the corresponding number of conference units to the central unit.
- ▶ Switch the central unit on. The central unit performs a self-test.



If the number of participants increases after an error-free self-test, we **strongly** recommend you to perform a new self-test **before** starting your conference.

If an error or a warning occurs, proceed as follows:

- ▶ Eliminate the error (see the following tables).
- ▶ After error elimination, perform a manual self-test by selecting “Yes” in the “Start Self-Test” menu item:

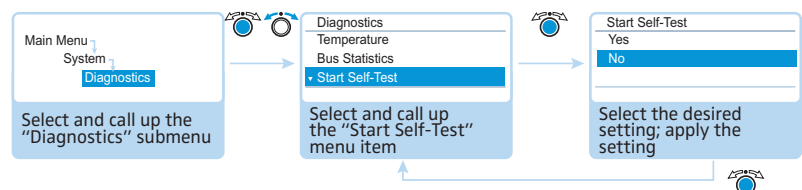

The central unit now checks if the reported error still occurs. If the error has been eliminated, the corresponding error icon will go off after the self-test.

The following tables show possible error indications and steps for error elimination.

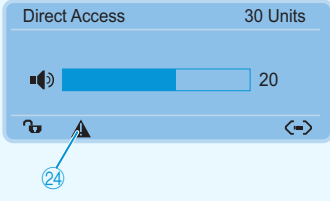
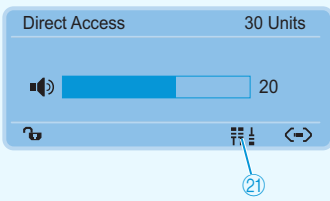
<p>Display</p>	 <p>Only the warning triangle ②④ is displayed.</p>
<p>Error and remedy</p>	<p>Several errors may have occurred.</p> <p>► Check the following menu items one after the other (see page 38):</p> <ul style="list-style-type: none"> <li>– “System Load”</li> <li>– “Temperature”</li> <li>– “Bus Statistics”</li> </ul> <p>If the menu items display errors, follow the options and/or steps for error elimination mentioned there.</p>
<p>Display</p>	 <p>Only the structural change icon ②① is displayed.</p>
<p>Error</p>	<p>Change in the number of conference units due to:</p> <ul style="list-style-type: none"> <li>• manual adding or removal of one or several conference units</li> <li>• automatic resetting of one or several conference units (the conference units restart)</li> <li>• switch-off of one or several conference units due to under-voltage</li> <li>• disconnection of one or several conference units e.g. caused by             <ul style="list-style-type: none"> <li>– faulty plug connections</li> <li>– wire or cable faults</li> </ul> </li> </ul>

<p><b>Remedy</b></p>	<ul style="list-style-type: none"> <li>▶ Perform a manual self-test (see page 40). The display can change as follows:             <ul style="list-style-type: none"> <li>– The structural change icon ⑳ disappears: The structural change has been detected, there are no errors.</li> <li>– The structural change icon ⑳ is still displayed: Follow the steps below.</li> </ul> </li> </ul> <p>If, after performing the self-test, the structural change icon ⑳ is still displayed:</p> <ul style="list-style-type: none"> <li>▶ Reset the error counter (“Break Counter”) (see page 40).</li> <li>▶ Change to the “Bus Statistics” menu item (see page 39) and check the digit behind “Break Counter”.</li> <li>▶ Carefully move the conference units and systems cables and check if the digit behind “Break Counter” is increased. If the digit is increased, check the corresponding plug connections or replace the corresponding conference units and system cables.</li> </ul> <p>If the error still occurs:</p> <ul style="list-style-type: none"> <li>▶ Follow the steps described in the “System Load” menu item (see page 38).</li> <li>▶ Perform a manual self-test (see page 40).</li> </ul>
----------------------	--

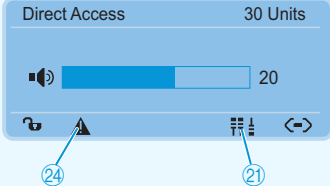
<p><b>Display</b></p>	 <p>The warning triangle ⑳ and the structural change icon ㉑ are displayed.</p>
-----------------------	---

<p><b>Error and remedy</b></p>	<p>Change in the number of conference units during the self-test:</p> <p>After switch-on, an automatic self-test is performed which simulates a running conference with all the conference units connected.</p> <p>If a failure of conference units occurs, the above mentioned error icons appear.</p> <p>A failure of conference units can be caused by undervoltages or overcurrents:</p> <ul style="list-style-type: none"> <li>▶ Follow the steps described in the “System Load” menu item (see page 38).</li> <li>▶ Perform a manual self-test (see page 40).</li> </ul>
--------------------------------	--

**Display**

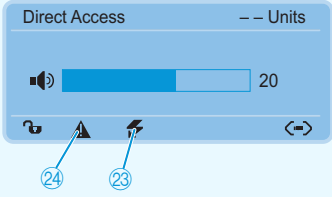

The warning triangle <sup>24</sup> and the structural change icon <sup>23</sup> are displayed.

The "Units" display displays no conference units ("--"), the corresponding connection socket **PORT I** or **PORT II** is deactivated.

**Error and remedy**

Short-circuit caused by:

- metal parts (e.g. paper clips) that bridge the contacts of the plug connections
- faulty system cables
- wrong cables (e.g. crossover cables)

▶ Check if you are using the correct system cables.

▶ Follow the steps described under the "System Load" menu item (see page 38).

▶ Perform a manual self-test (see page 40).

The "Units" display displays the connected conference units (e.g. "08"), the previously deactivated connection socket **PORT I** or **PORT II** is activated again.

**Display**

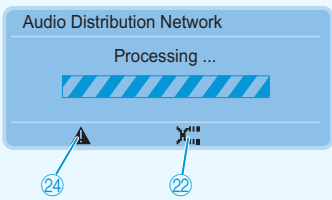

The warning triangle <sup>24</sup> and the cable fault icon <sup>22</sup> are displayed and the "Processing..." bar appears.

**Error and remedy**

Wrong cabling; the microphone LED <sup>8</sup> and the signal light ring <sup>2</sup> of the affected conference unit flash red.

▶ Check if the cables are connected correctly (see page 17).

**Displaying the type and number of conference units connected to the connections PORT I or PORT II – "Ports"**

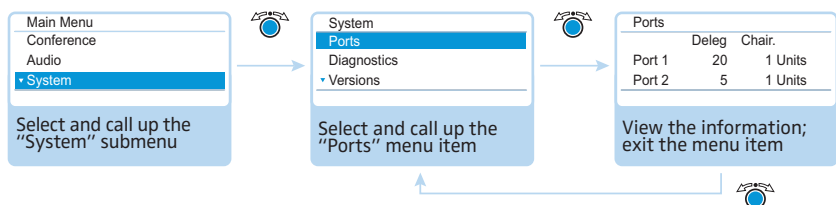

The "Ports" menu item displays the number of delegate units ("Deleg") and chairman units ("Chair.") connected to the connection sockets **PORT I** and **PORT II**.

### System analysis – “Diagnostics” submenu

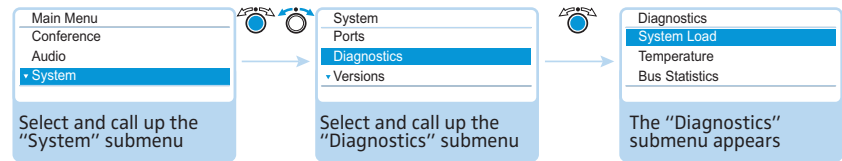

The “Diagnostics” menu item provides information on the status of the current and voltage supply, on the status of data transmission and on interruptions due to faulty cables or cable connections.

### Displaying status information on the current and voltage supply – “System Load”

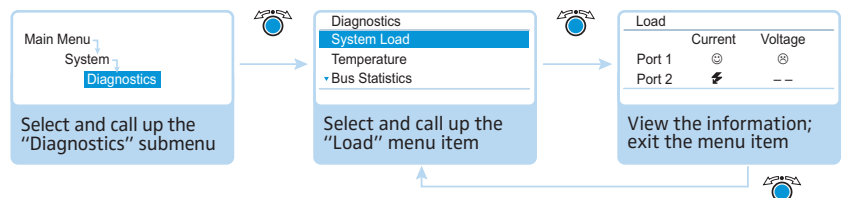

Both ports can be subjected to undervoltages, overcurrents and short-circuits:

Display	Meaning and causes
Current ☹️	An overcurrent in the central unit can be caused by <ul style="list-style-type: none"> <li>metal parts (e.g. paper clips) that bridge the contacts of the plug connections</li> <li>faulty conference units</li> <li>faulty system cables</li> <li>too long system cables</li> <li>too many conference units connected to one port</li> </ul>
Voltage ☹️	An undervoltage can be caused by <ul style="list-style-type: none"> <li>faulty conference units</li> <li>too long system cables</li> <li>too many conference units connected to one port</li> </ul>
Current ⚡	A short-circuit in the central unit can be caused by e.g. <ul style="list-style-type: none"> <li>metal parts (e.g. paper clips) that bridge the contacts of the plug connections</li> <li>faulty system cables</li> <li>wrong cables (e.g. crossover cables)</li> </ul>
Voltage --	The port is deactivated due to e.g. <ul style="list-style-type: none"> <li>no conference units connected</li> <li>a short-circuit</li> </ul>

If an error icon appears (see page 34), check your conference system for the errors mentioned above.



If an error is detected **at startup** of the central unit, first eliminate the error and then perform a manual **self-test** (see page 40) in order to check if the error still occurs.

If an error has only occurred **during operation** and has already been eliminated, this is automatically detected by the central unit.

Possible steps for error elimination:

- Eliminate the errors separately for each port.
- Calculate the maximum length of the cable string (see page 13) and, if necessary, reduce the cable length.
- Reduce the number of conference units to 15-20 max. per cable string.

- If necessary, further reduce the number of conference units until there are no errors reported.  
Then add conference units one after the other and observe the central unit's display. If an error is reported, the cause of the error might be the last added conference unit, the cable used or metal parts that bridge the contacts of the plug connection.

Displaying the temperature status – “Temperature”

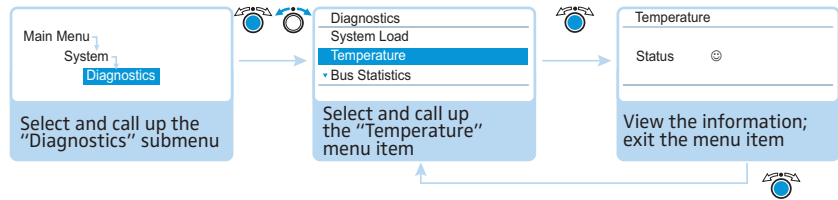

If the temperature within the central unit is too high (display: “☹”), proceed as follows:

- ▶ Make sure that the air vents are not covered or blocked (see page 15).
- ▶ If necessary, clean the air vents (see page 104).

If the central unit is mounted into a rack:

- ▶ Provide additional ventilation by providing for a clearance below the central unit and/or installing additional fans into the rack.

When the temperature is again within the permissible temperature range, this is automatically detected by the central unit (display: “☺”). The temperature check is carried out cyclically.

If, in spite of these measures, the temperature is still detected to be too high, one of the fans might be faulty:

- ▶ Have the fans checked and, if necessary, replaced by qualified maintenance personnel.

Displaying system bus errors – “Bus Statistics”

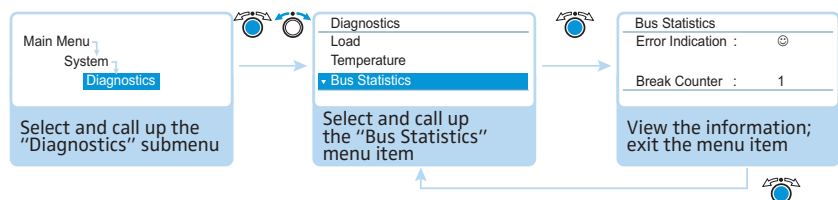

Possible causes for system bus errors are:

- changes in the number of conference units
- faulty cables
- faults in cable shields
- faulty conference units
- strong electromagnetic fields

If there are system bus errors, the “☹” icon appears behind “Error Indication”. The display panel lights up red and the warning triangle 24 is displayed on the standard display (see page 34).

There are temporary or permanent transmission errors:

Temporary transmission errors can be caused by e.g. poorly shielded mobile phones that are placed too close to the system cables or conference units. If the transmission error no longer exists, the “☺” icon appears on the display. The display panel lights up orange and the warning triangle 24 goes off.



Permanent transmission errors must be eliminated immediately in order to ensure trouble-free operation of your conference system. Follow the steps for error elimination described under the **“System Load”** menu item (see page 38). In addition, check if other electronic devices in the proximity of the conference system might cause the errors.

You can manually reset the **“☹”** icon behind **“Error Indication”** to the default icon (**“☺”**) (see page 40).

The error counter (**“Break Counter”**) incrementally counts all errors and changes in the conference system (e.g. added conference units). Based on the changes of the counter’s counts, you can conclude on the error source (e.g. if the counter rapidly increments when you wiggle the cable, this indicates a faulty cable).

You can manually reset the error counter (**“Break Counter”**) (see page 40).

Performing a manual self-test – **“Start Self-Test”**

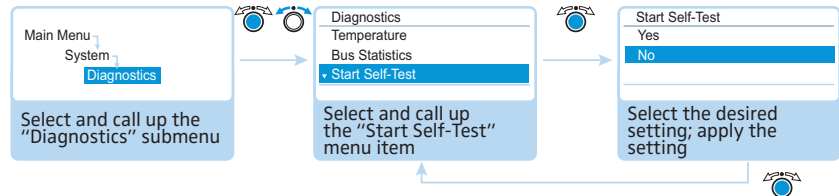

If the central unit detects errors after switch-on or during operation:

- ▶ Eliminate these errors (see page 34 and following).
- ▶ Perform a manual self-test by selecting **“Yes”** in the **“Start Self-Test”** menu item. The conference is interrupted. The central unit now checks if a reported error still occurs. If the error is eliminated, the corresponding error icon goes off after the self-test. If the error icon is still displayed, you have to take further steps to eliminate the error (see page 34 and following).



Always perform the self-test after you have eliminated the reported errors.

Resetting the error counter – **“Reset Break Indication”**

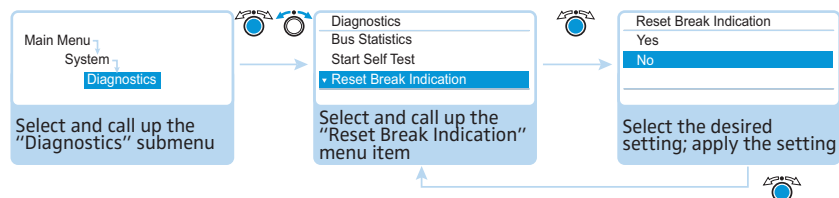

Possible settings: **“Yes”** or **“No”**

This menu item allows you to reset the error counter (**“Break Count”**) in the **“Bus Statistic”** menu item (see page 39).

Resetting the display of data bus errors – **“Reset Error Indication”**

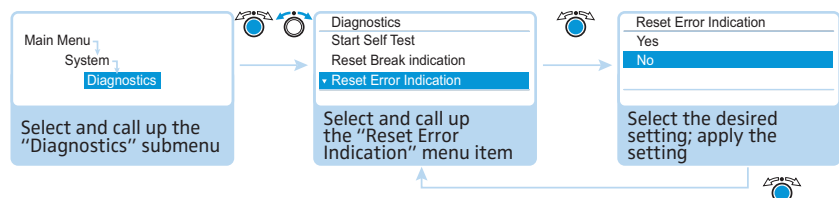

Possible settings: **“Yes”** or **“No”**

This menu item allows you to manually reset the display of data bus errors (**“Error Indication”**) in the **“Bus Statistic”** menu item to default (see page 39).



We **strongly** recommend to always perform a self-test (see page 40) in order to make sure that the error is eliminated.

After a successful self-test, the error icons go off and the display of data bus errors is automatically reset to default.

### Displaying the hardware and software version – “Versions” submenu

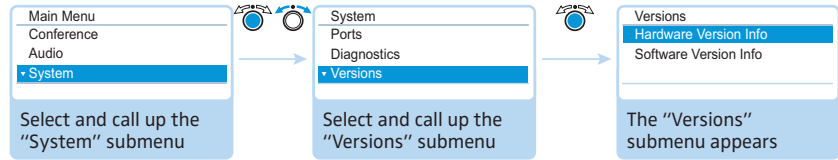

The “Versions” menu item provides information on your hardware and software versions.

Information on firmware updates for your conference system is available from your Sennheiser partner or from the download area on our website at [www.sennheiser.com](http://www.sennheiser.com).

#### Displaying the hardware version – “Hardware Version Info”

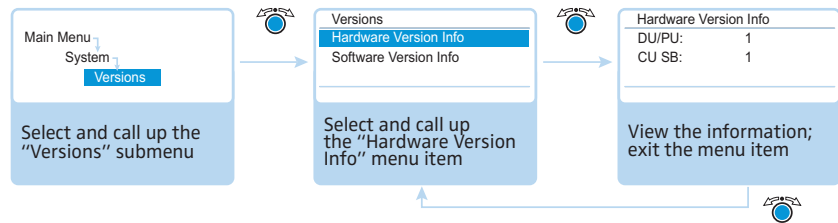

#### Displaying the software version – “Software Version Info”

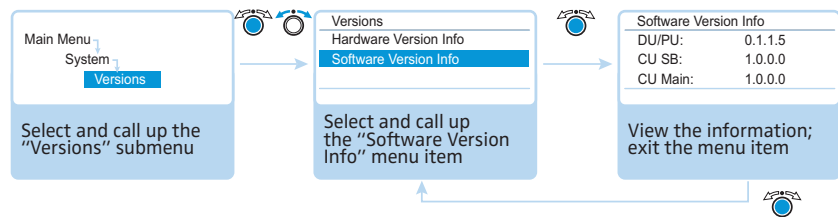

### Adjusting the language – “Language”

Via the “Language” menu item, you can adjust the language of the operating menu:

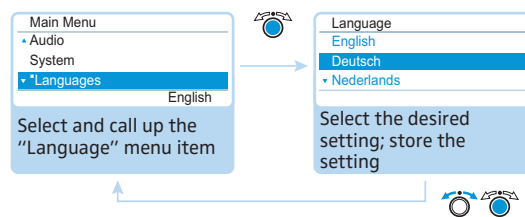

## Adjusting further settings – “Settings”

### Adjusting network settings – “Network” submenu

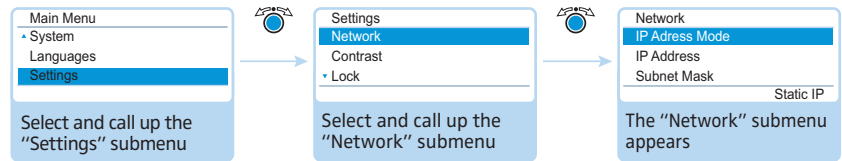

The “Network” submenu allows you to set the IP address allocation mode, the IP address and the subnet mask.

For detailed information on network settings, refer to the chapter “Preparing the Windows version of the software for use” on page 50.

### Setting the IP address allocation mode – “IP Address Mode”

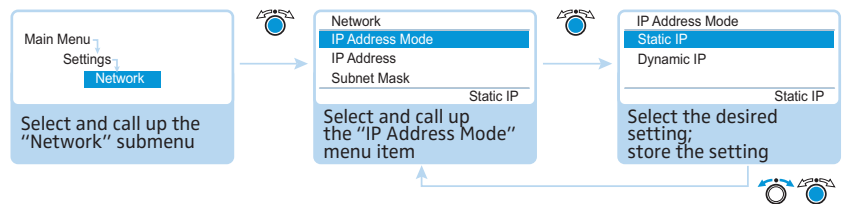

Possible settings: “Static IP” and “Dynamic IP”



By selecting “Static IP”, you gain access to the “IP Address” and “Subnet Mask” submenus (see the following sections).

### Setting a static IP address – “IP Address”

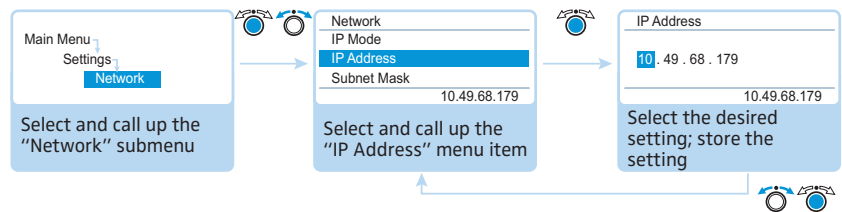

### Setting a static subnet mask – “Subnet Mask”

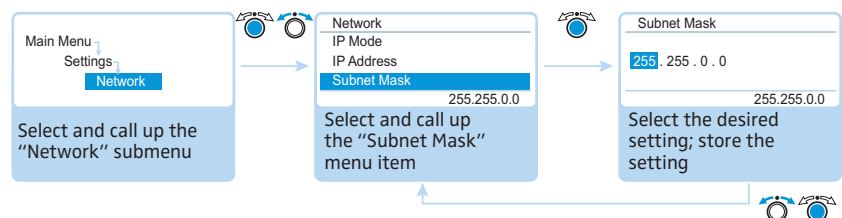

### Adjusting the contrast of the display panel – “Contrast”

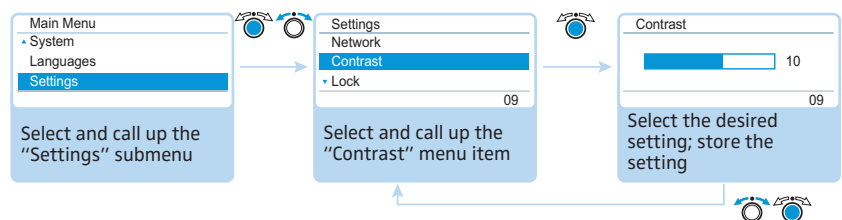

You can adjust the contrast of the display panel in 15 steps.

### Activating the lock mode – “Lock”

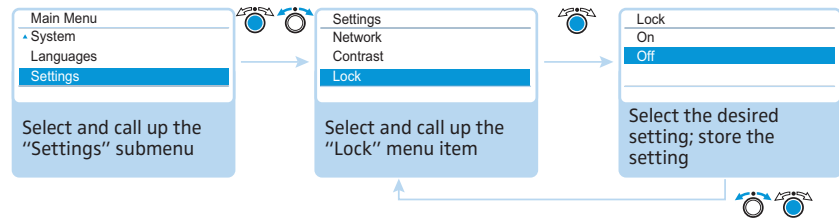

When you activate the lock mode, you are automatically returned to the standard display. For information on how to deactivate the lock mode, refer to page 21.

### Restoring the factory default settings – “Restore Factory Defaults”

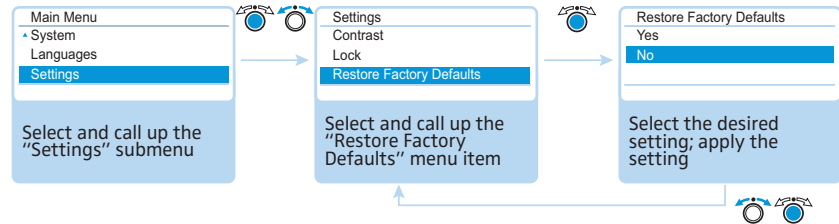

The “Restore Factory Defaults” menu item allows you to restore the factory default settings (see “Factory default settings” on page 111).

## Running a conference

The character of your conference (i.e. the conditions under which the participants can take the floor or are granted speaking privileges) depends on the settings of the central unit (see page 26).

Possible settings: “Direct Access”, “Override” and “Request”.

- “Direct Access” mode and “Override” mode:

These two conference modes do not require the use of a chairman unit.

If the maximum number of speakers who can take the floor simultaneously (“Microphone Limit”) has not been reached, a further speaker can take the floor immediately.

<b>Situation</b>	The maximum number of speakers who can take the floor simultaneously (“Microphone Limit”) has been reached.
<b>Event</b>	A further speaker presses the microphone key on his or her conference unit.
<b>Behavior</b>	In “Direct Access” mode: The speaker has to wait until one of the current speakers passes on or loses his or her speaking privileges. He or she is then automatically granted speaking privileges.  In “Override” mode: The speaker can take the floor immediately. The speaker with the longest speaking time loses his or her speaking privileges.

- “Request” mode:

For this mode to function, a chairman unit is required.

In “Request” mode, the chairman receives requests to speak and grants speaking privileges according to the FIFO principle (First In – First Out), i.e. the speaker with the longest waiting time is granted speaking privileges.

<b>Situation</b>	The maximum number of requests to speak has been reached (“Request Limit”).
<b>Event</b>	A further speaker makes a request to speak.
<b>Behavior</b>	The speaker can only make a request to speak if the maximum number of requests to speak drops below the specified limit value.



You can control the conference either via chairman units (see the following chapters) or via the “Conference Manager” software (see page 49).

## Operating a delegate unit

### Taking the floor/Making a request to speak

Depending on the conference mode set (see page 26) you can

- take the floor immediately or
- make a request to speak.

You then have to wait until the chairman activates your microphone.

If the conference mode is set so that you can take the floor immediately (“**Direct Access**” mode (factory default setting) or “**Override**” mode, see page 26):

- ▶ Press the microphone key **7**.  
Your microphone is activated and you can take the floor immediately. The microphone LED **8** and the signal light ring **2** light up red. The loudspeaker **9** is muted. Depending on the conference mode and the microphone limit set, the microphone of the previous speaker will be deactivated.

If the conference mode is set so that you first have to make a request to speak (“**Request**” mode, see page 26):

- ▶ Press the microphone key **7**.  
Your request to speak is added to the request-to-speak list.

Depending on the setting adjusted in the operating menu (see page 30):

- the microphone LED **8** flashes green and the signal light ring **2** flashes red or
- only the microphone LED **8** flashes green.

When the chairman grants you speaking privileges, your microphone is activated. The microphone LED **8** and the signal light ring **2** light up red. The loudspeaker **9** is muted. Depending on the conference mode and the microphone limit set, the microphone of the previous speaker will be deactivated.



With a chairman unit, you can take the floor at any time, without first having to be granted speaking privileges.

If you are using delegate units **only**, you can only choose conference modes where speaking privileges do not have to be granted by a chairman (“**Direct Access**” or “**Override**” mode, see page 26). Alternatively, you can use the “Conference Manager” software to control the delegate units (see page 95).

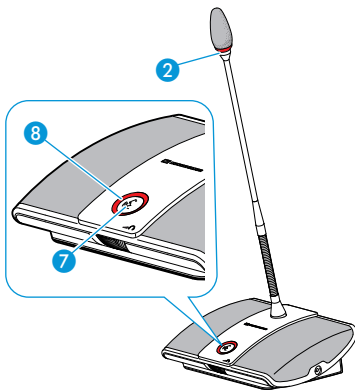

### Deactivating the microphone/Canceling a request to speak

To deactivate the microphone when you have finished speaking or to cancel a request to speak:

- ▶ Press the microphone key **7** once more.  
The microphone LED **8** and the signal light ring **2** go off.

### Connecting headphones

You can connect mono or stereo headphones to the conference unit to listen to the floor channel. The headphone volume can be individually adjusted on the conference unit.

- ▶ Connect headphones with a 3.5 mm jack plug to the headphone socket ③.

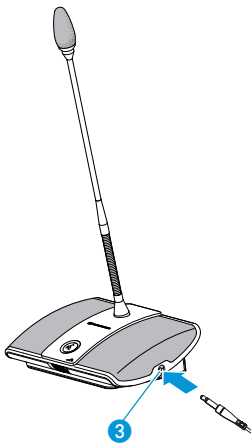

### Setting the headphone volume

#### CAUTION Hearing damage due to high volumes!



Listening at high volume levels for long periods can lead to permanent hearing defects.

- ▶ Inform the conference participants about this fact.
- ▶ Set the volume to a medium level.
- ▶ Do not continuously expose yourself and other conference participants to high volumes.

- ▶ Put the headphones on.

To set the volume:

- ▶ Turn the headphone volume control ⑥
  - to the right to increase the volume or
  - to the left to reduce the volume.

At switch-off, the headphone volume is reset to a medium level.

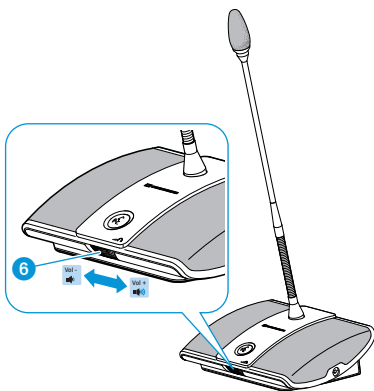

The volume of the conference units' loudspeakers can be set via the central unit (see page 48).

### Operating a chairman unit

Beside the chairman functions, chairman units offer the same functions as delegate units (see page 45).

With a chairman unit, you can take the floor at any time.



If your conference system comprises several chairman units, all chairman units have equal rights.

### Granting speaking privileges

If – in “Request” mode – a participant presses the microphone key on his or her delegate unit, he or she makes a request to speak. All participants who have made a request to speak will join a request-to-speak list.

Depending on the setting adjusted in the operating menu (see page 30):

- the microphone LED 8 flashes green and the signal light ring 2 flashes red or
- only the microphone LED 8 flashes green.

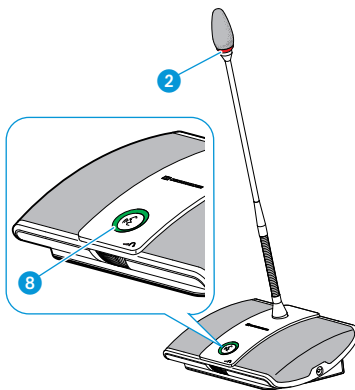

To grant speaking privileges to the next participant from the request-to-speak list:

- ▶ Press the NEXT key 5.

The next participant from the request-to-speak list is granted speaking privileges.

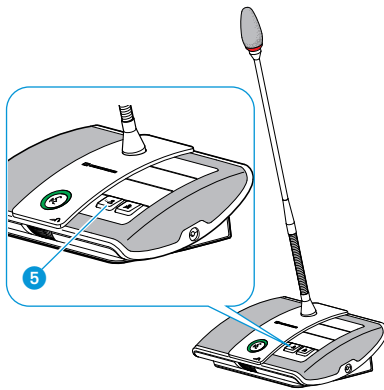

If you are using the “Conference Manager” software, you can also grant speaking privileges with a mouse click (see page 99).

### Ending a conference or withdrawing speaking privileges (cancel function)

Depending on the setting adjusted in the operating menu (see page 30):

- All LEDs go off and the delegate units are deactivated. A request-to-speak list, if available, is cleared.
- All currently active delegate units are deactivated. All requests to speak are retained.

- ▶ Briefly press the priority key 4.

The conference system behaves as set.

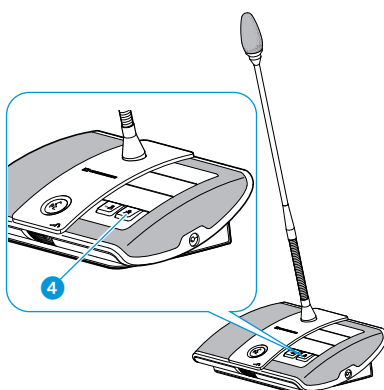

If you are using the “Conference Manager” software, you can also deactivate all delegate units with a mouse click (see page 95).



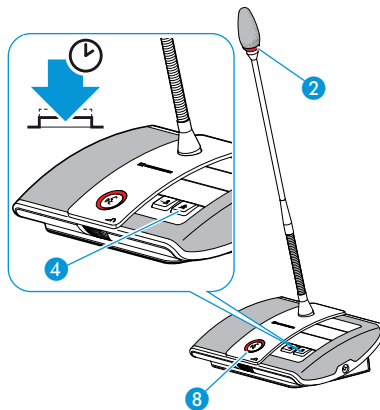

### Muting all delegate units temporarily (priority function)

Using the priority function, the chairman can interrupt a discussion at any time. The speaking privileges of all chairman units remain active at any time.

- ▶ Keep the priority key 4 pressed for as long as you want to mute the conference units.  
All conference units – except for the chairman units – are muted immediately. The microphone LED 8 and the signal light ring 2 of the previously active conference units flash red. You can take the floor immediately. The microphone LED 8 and the signal light ring 2 of your chairman unit light up red.
- ▶ Release the priority key 4.  
The muting of the conference units is canceled. The discussion is continued.

### Setting the volume of the conference units' built-in loudspeakers

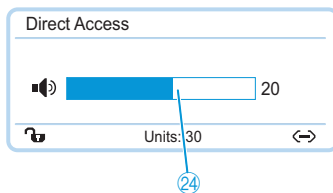

You can set the volume of the conference units' built-in loudspeakers via the jog dial on the central unit. The standard display 18 displays the current volume setting.

#### CAUTION Danger of hearing damage due to loud hissing!



When the floor channel volume is set to a high level or when several participants speak simultaneously, feedback noise (loud hissing) can occur. This can cause hearing damage.

- ▶ Reduce the floor channel volume (see page 48, page 93 or page 101).
- ▶ Make sure that the "Audio Gain Reduction" function is activated (see page 32). This function reduces the gain per active microphone by the selected level and thus prevents feedback noise.
- ▶ Increase the distance between the individual conference units to at least 50 cm.



- ▶ Turn the jog dial
  - to the right to increase the volume or
  - to the left to reduce the volume.



The volume of the conference units' loudspeakers can also be set via the central unit's operating menu (see page 32) or the "Conference Manager" software (see page 93).

### Adding conference units to the conference system during operation

You can add conference units to the conference system during operation.



When adding conference units to the conference system, observe the maximum number of conference units in order to ensure safe operation (see page 13).

All delegate units are ready for immediate use. The chairman units have to be re-initialized. Note that this will interrupt the conference (see page 30 or page 88).

# Using the "Conference Manager" software

## Possibilities of usage of the software and the conference system

The "Conference Manager" software allows you to conveniently manage and control the conference system. With the software, you can plan and graphically simulate conferences. Various configurations can be saved and thus be reused for other scenarios. In addition, you can use the software to control conferences. Conference rooms and conference participants are represented graphically, allowing you to keep track of and securely manage your conferences.

### Hardware platforms for the software

The "Conference Manager" software can be run in two different ways:

Using the software preinstalled on the central unit

The software is preinstalled on the central unit. In order to be able to use the software, you have to connect a screen, mouse and keyboard directly to the central unit (see "Preparing the central unit's integrated software for use" on page 50).

Using the software on a Windows PC

Alternatively, you can install the software on a Windows PC. You then have to integrate the PC together with the central unit in a network (see "Preparing the Windows version of the software for use" on page 50).

### "Setup" and "Live" operating mode

Planning and simulating conferences – "Setup" operating mode

In "Setup" operating mode, you can plan, configure and simulate conference situations. The software allows you to easily plan your conference by simulating a conference room, e.g. using lines, colors and photos. You can realistically simulate room situations, manage the names of the conference participants and assign these names to individual conference units. All conference settings can be adjusted and saved via the "Conference Manager" software. These settings can then be used in "Live" operating mode.

Controlling conferences via the software – "Live" operating mode

In "Live" operating mode, you can control a conference from your screen. For controlling the conference, you can choose between two views: "Room View" and "Delegate View". You can see at a glance which delegates are currently speaking and which have made a request to speak and you can activate or deactivate individual conference units just with a mouse click.

### Establishing a connection between the software and the conference system

In order to be able to control a conference via the "Conference Manager" software, you have to connect the software to the conference system. If you are using a networked Windows PC, you can select different central units in the network. The software preinstalled on a central unit can only be connected to its central unit.

If you want to preconfigure a conference system, you can also use the "Conference Manager" software if there is no connection to the central unit.

The following overview shows the functions that are available depending on the connections status:

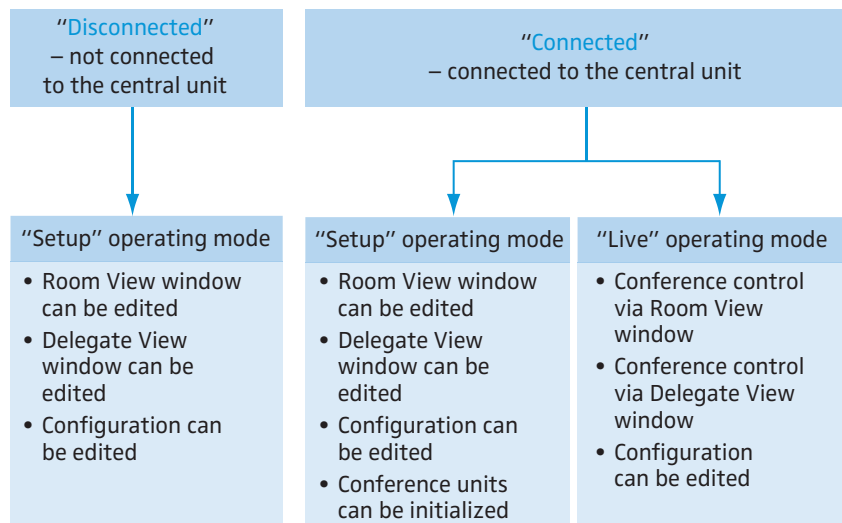

## Preparing the central unit's integrated software for use

### Connecting and configuring the screen, mouse, and keyboard

- ▶ Connect the screen, mouse, and keyboard to the central unit (see page 19).

To optimally use the screen, mouse, and keyboard, you have to configure the devices one time:

- ▶ Adjust the setting for the screen, mouse, and keyboard to your needs (see page 63).

## Preparing the Windows version of the software for use

### System requirements

Component	Requirement
Processor	Intel Pentium 4 or AMD Athlon XP, 2 GHz or more
RAM	Min. 512 MB
Hard disk	Min. 150 MB free hard disk memory
Drives	CD ROM or DVD ROM
Interfaces/network	Ethernet 100 MBit/s
TCP/IP internet protocol	Internet Protocol version 4 (IPv4)
Screen	Minimum resolution: 800 x 600 pixels Recommended: 1024 x 768 pixels
Operating system	Microsoft Windows XP Professional with SP 2 Microsoft Windows Vista Microsoft Windows 7

### Installing the "Conference Manager" software

- ▶ Start the "ADNSetup.exe" file in the "Conference Manager" folder on the enclosed CD ROM.

A confirmation prompt appears:

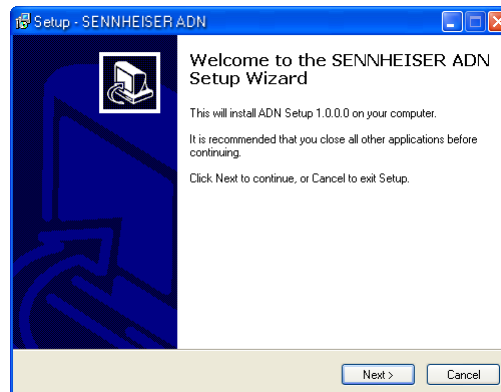

- ▶ Click the "Next" button.  
A selection window appears:

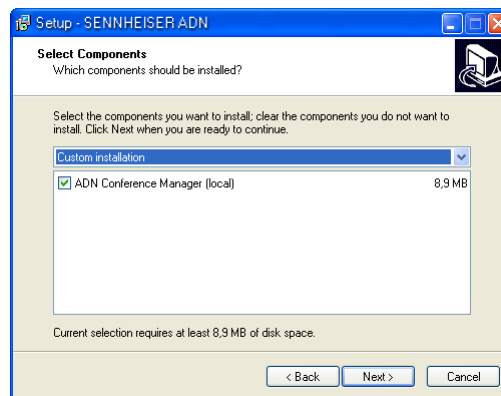

ADN Conference Manager (local)

- ▶ Make sure that the "ADN Conference Manager (local)" check box is ticked.
- ▶ Click the "Next" button.

A summary of the installation settings is displayed:

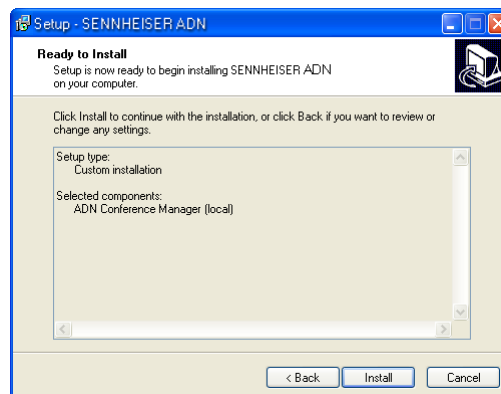

- ▶ Confirm this summary by clicking the "Install" button.  
The installation starts.
- ▶ Follow the instructions of the Installation Wizard.

Adjusting the network settings

To enable communication between the central unit and the Windows PC:

- ▶ Make sure that the network communication between the central unit and the Windows PC is not blocked by a proxy server and/or a firewall.  
Ports 53248, 53249, 53250, 53251 are used for communication and port 21 is used for FTP transfer.
- ▶ Ask your system administrator if a static IP address is to be used or if the IP address is to be allocated dynamically.  
If you have to use a static IP address, ask for the subnet mask and the standard gateway.
- ▶ Use the information provided by your system administrator to adjust the network settings of your central unit. Proceed as described under b) in the table on page 54.

If you have to make the decision whether to use static or dynamic IP addressing, proceed as follows:



If the central unit is directly connected to a Windows PC, we recommend dynamic IP address allocation. Adjust the network settings of the PC and the central unit as described under a) in the table on page 53.

The devices automatically detect whether IP address allocation is via DHCP or Zero Configuration Networking (Zeroconf). This process can take several minutes.

Windows XP	Windows Vista	Windows 7
<p>▶ Click "Start" and then select "Control Panel".</p>		
<p>The "Control Panel" window appears.</p>		
<p>▶ Double click "Network and Internet Connections":</p>	<p>▶ Click "View network status and tasks":</p>	<p>▶ Click "View network status and tasks":</p>
<p>The "Network and Internet connections" window appears.</p>	<p>The "Network and Sharing Center" window appears.</p>	<p>The "Network and Sharing Center" window appears.</p>

**Windows XP**      **Windows Vista**      **Windows 7**

▶ Click "Network Connections" in the right column:



The "Network Connections" window appears.

▶ Click "Manage network connections" in the left column:

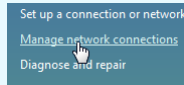

The "Network Connections" window appears.

▶ Click "Change adapter settings" in the left column:

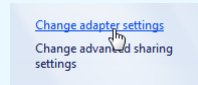

The "Network Connections" window appears.

▶ Double-click "Local Area Connection":



The "Local Area Connection Status" window appears.

▶ Double-click "Local Area Connection":

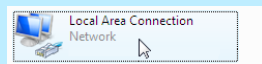

The "Local Area Connection Status" window appears.

▶ Double-click "Local Area Connection":

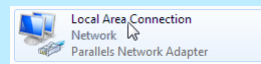

The "Local Area Connection Properties" window appears.

▶ Click the "Properties" button:

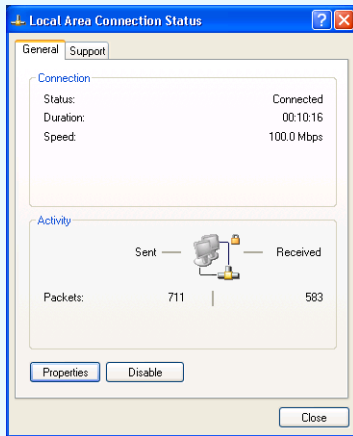

The "Local Area Connection Properties" window appears.

▶ Click the "Properties" button:

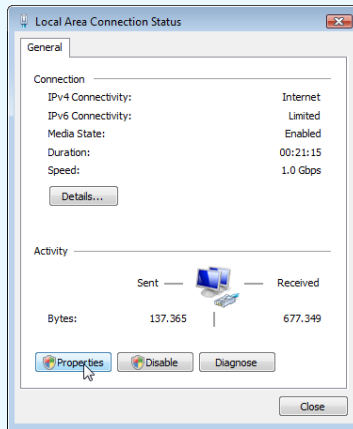

The "Local Area Connection Properties" window appears.

▶ Click the "Properties" button:

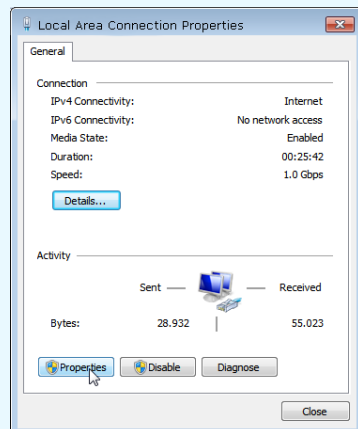

The "Local Area Connection Properties" window appears.

▶ In the "This connection uses the following items" box, scroll to the bottom.

▶ Double-click "Internet Protocol (TCP/IP)".

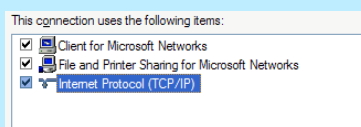

The "Internet Protocol (TCP/IP) Properties" window appears.

▶ In the "This connection uses the following items" box, double-click "Internet Protocol Version 4 (TCP/IPv4)".

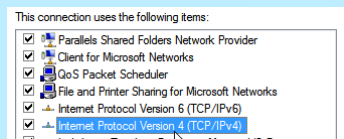

▶ In the "This connection uses the following items" box, double-click "Internet Protocol Version 4 (TCP/IPv4)".

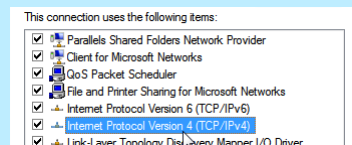

Here you can see whether the Windows PC is assigned a static or dynamic IP address. Adjust your central unit as follows:

**a) The Windows PC is assigned a dynamic IP address in the network:**

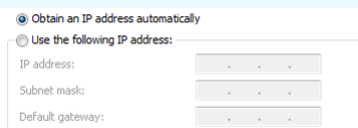
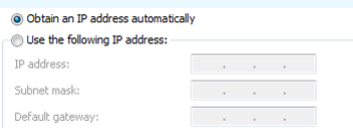
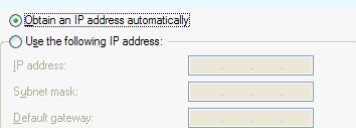

Windows XP	Windows Vista	Windows 7
------------	---------------	-----------

Settings to be adjusted via the central unit (see page 42):

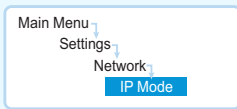

- ▶ On the central unit, call up the "IP Mode" menu item.
- ▶ Select "Dynamic IP".  
The central unit is automatically integrated in the network and no further steps have to be taken.

**b) The Windows PC is assigned a static IP address in the network:**

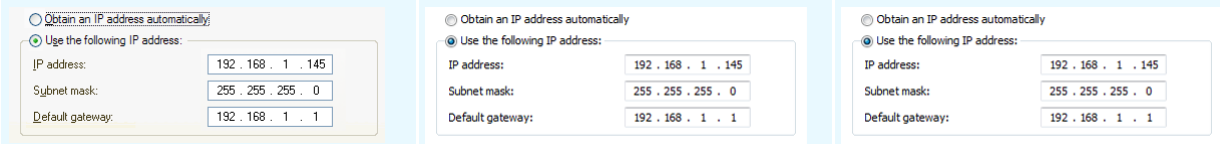

Settings to be adjusted via the central unit (see page 42):

- ▶ On the central unit, call up the "IP Mode" menu item.

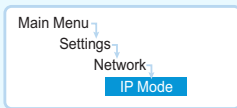

- ▶ Select "Static IP".
- ▶ Determine the network part of the IP address of the Windows PC and note it down:

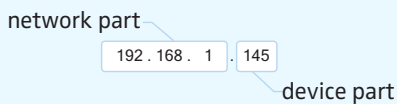

In this example, the network part is "192.168.1".

- ▶ On the central unit, call up the "IP-Address" menu item:

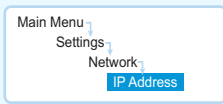

- ▶ Set the network part of the IP address to the value retrieved from your Windows PC.
- ▶ Set the device part (the last three digits) of the IP address to a value ("1" - "254") that is neither used by your PC nor by another computer in your network (in this example, the device part must not be "145").

## Starting/exiting the software

### The central unit's integrated software

To start the central unit's integrated software:

- ▶ Switch on the central unit and the connected screen.  
The "Conference Manager" software is started in "Setup" operating mode and the Room View window is displayed. The "Open" window appears in the foreground.



If the screen connected to the central unit does not show anything, it may be that the screen resolution is set too high. In this case, reset the screen resolution:

- ▶ Press the key combination "CTRL" + "SHIFT" + "F1".  
The screen resolution is reset to 800 x 600 pixels.

To exit the software:

- ▶ If necessary, save your current configuration (see page 69).
- ▶ Switch off the central unit.

### The Windows version of the software

To start the software:

- ▶ Double-click the program icon on the desktop.

Or:

- ▶ Click "Start" > "All Programs" > "Sennheiser" > "ADN" > "SENNHEISER Conference Manager".

The "Conference Manager" software is started in "Setup" operating mode and the Room View window is displayed. The "Open" window appears in the foreground.

To exit the software:

- ▶ If necessary, save your current configuration (see page 69).
- ▶ Click the button on the toolbar.





## Getting to know and adjusting the basic features of the software

### Overview of the software

The main application window of the "Conference Manager" software consists of permanently visible elements and on views that depend on the operating mode.

The following diagram shows the Windows version of the "Conference Manager" software:

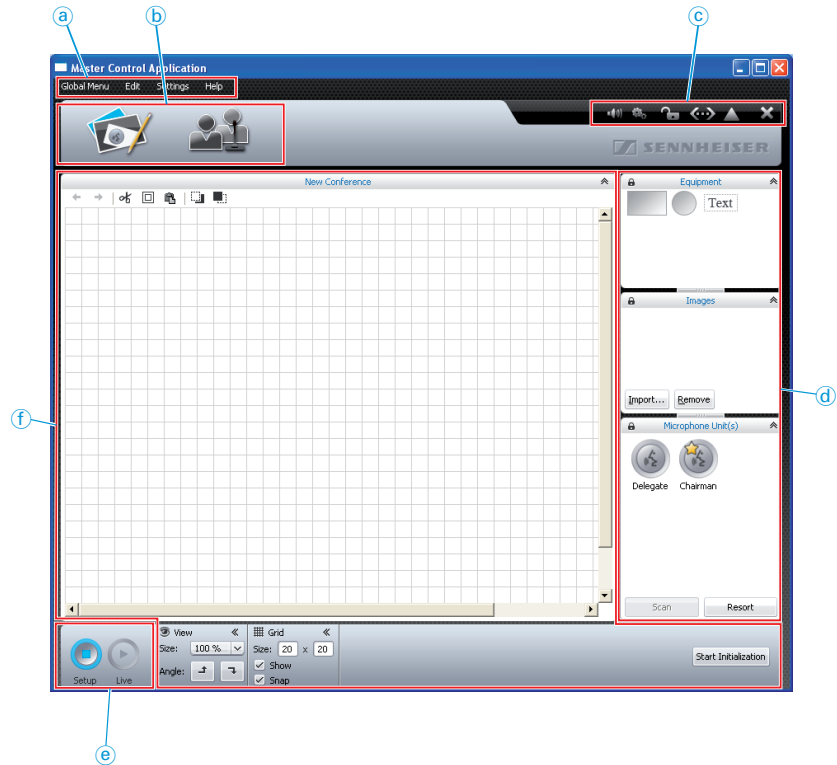

- a Menu bar
- b Buttons for selecting the views
- c Toolbar
- d Library panels
- e Buttons for selecting the operating mode
- f Views

Menu bar 

Global Menu Edit Settings Help

Menu	Submenu	Function	Page
Global Menu	New Conference	Creates a new configuration	67
	Open Conference ...	Loads an existing configuration	68
	Delete Conference	Deletes and existing configuration	71
	Close	Closes the current configuration	70
	Save	Saves the current configuration (locally or on the central unit)	69
	Save as ...	Saves the current configuration under a different file name (locally or on the central unit)	
	Connect/ Disconnect	Establishes a connection to the central unit/disconnects a connection	66
	Autoload ...	Automatically loads the central unit's configuration at startup	69
	Exit*	Exits the software	55
	Edit	Undo	Reverses the last action you performed
Redo		Reverses the last Undo action	
Cut		Cuts an object and pastes it to the clipboard	81
Copy		Copies an object to the clipboard	
Paste		Pastes an object from the clipboard	
Delete		Deletes an object	
Step to back		Moves the object one level to the back	81
Step to front		Moves the object one level to the front	
Select All		Selects all objects	76
Full Screen*		Activates/deactivates full screen mode	63
Settings	Conference Settings ...	Opens the conference settings	90
	Audio Settings ...	Opens the audio settings	93
	Language	Adjusts the language	64
	Set Password ...	Sets the password protection	64
	Network	Opens the network settings	65
	Re-init Conference	Re-initializes the conference units	88
	Restore Factory Settings	Restores the factory default settings of the software	65
	System Properties **	Opens the hardware settings for screen, mouse and keyboard	63
Help	Help ...	Starts the help function	–
	About ...	Displays the current software version	–

\* only visible when you are using the Windows version of the software

\*\* only visible when you are using the central unit's integrated software



Alternatively, you can also use the keyboard shortcuts listed next to the commands.

Buttons for selecting the views **b**



Button	Function
	Changes to the Room View window where you can configure and/or control the conference system via a graphical interface. The Room View window changes depending on whether "Setup" or "Live" operating mode is set (see page 59).
	Changes to the Delegate View window where you can create a delegate list and control the conference by means of the list. The Delegate View window changes depending on whether "Setup" or "Live" operating mode is set (see page 59).

Toolbar **c**



Button	Function
	Opens the "Audio Settings" window (see page 93)
	Opens the "Conference Settings" window (see page 90)
	Displays the status of the central unit's lock mode (see page 93) "Device Unlocked" "Device Locked"
	Displays the connection status between the central unit and the "Conference Manager" software (see page 66) "Device Unconnected" "Device Connected"
	Displays detected errors and opens the event log (see page 102) "Event Log" "Errors detected"
	Closes the software ("Exit") (see page 55)

\* only available in the Windows version of the software

Buttons for selecting the operating mode **e**



Button	Function
	Sets the "Setup" operating mode which allows you to configure the conference system (see page 60). The button is highlighted in blue. The Room View window and the Delegate View window change their appearance in accordance with the selected operating mode.
	Sets the "Live" operating mode which allows you to control a conference using the software (see page 61). The button is highlighted in red. The Room View window and the Delegate View window change their appearance in accordance with the selected operating mode.

### Selecting operating modes and views

In "Setup" and "Live" operating mode, you can switch between the Room View window and the Delegate View window.

#### Views of the software depending on the operating mode

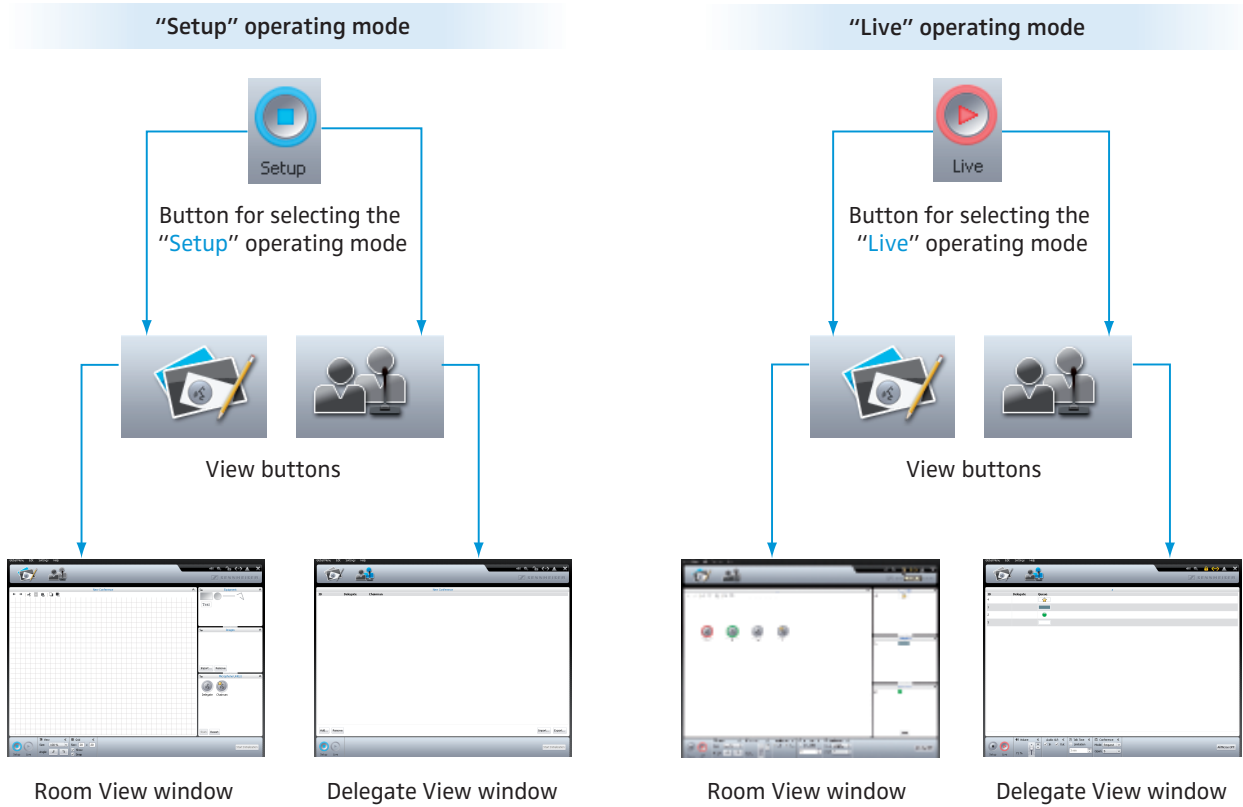

Selecting the "Setup" operating mode



- ▶ Click the "Setup" button. The software changes to "Setup" operating mode and the "Setup" button is highlighted in blue.

To display the Room View window:

- ▶ Click the Room View button .

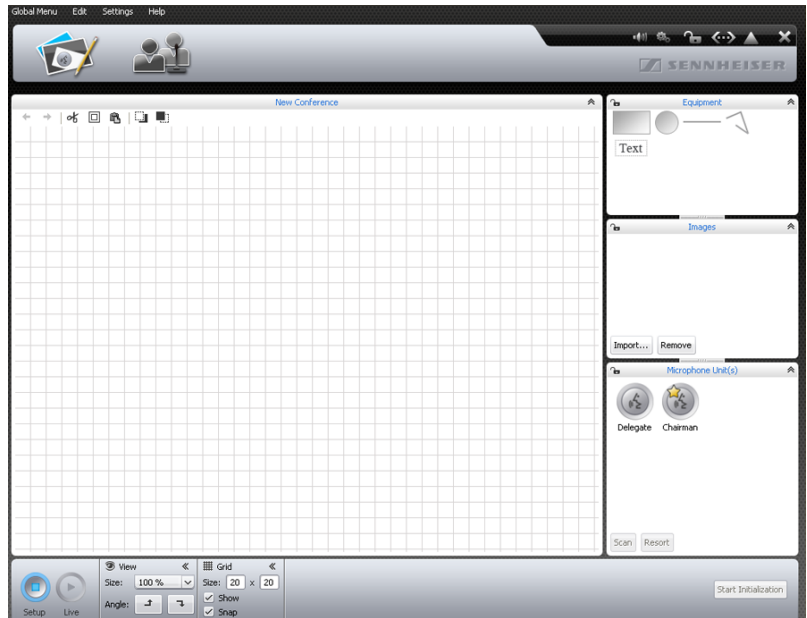

To display the Delegate View window:

- ▶ Click the Delegate View button .

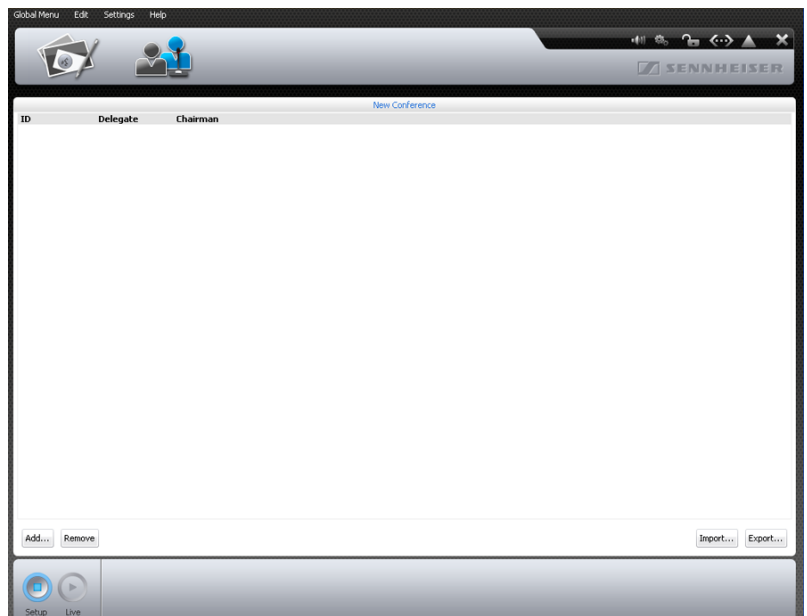

Selecting the "Live" operating mode



- ▶ Prepare the "Live" operating mode and activate it (see page 95).

To display the Room View window:

- ▶ Click the Room View button .

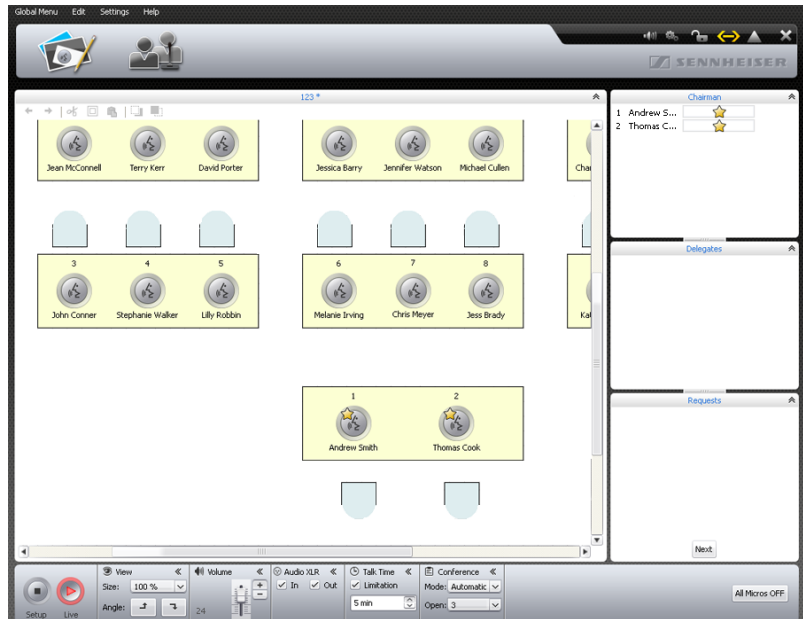

To display the Delegate View window:

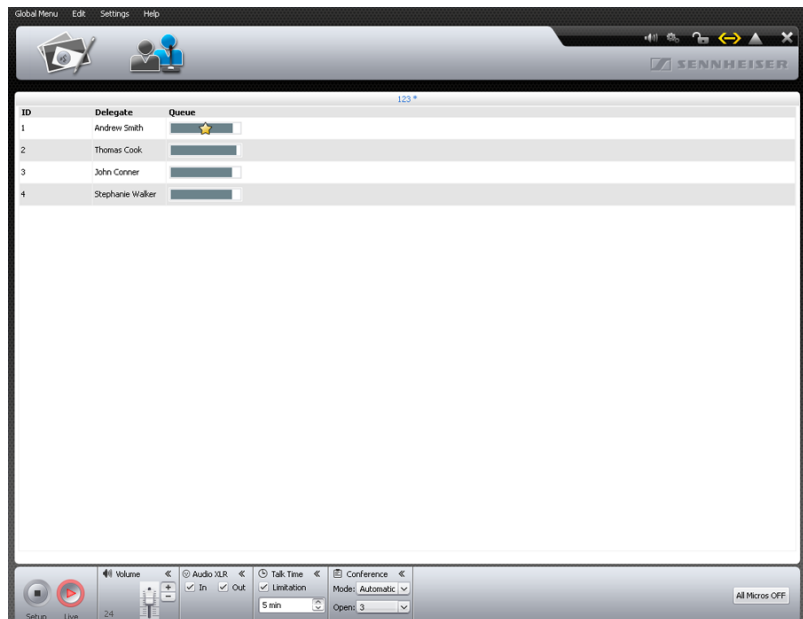

- ▶ Click the Delegate View button .



### Adjusting the Room View window and the Delegate View window to your needs

You can adjust the Room View window and the Delegate View window to your needs. The library panels can be hidden or shown and can be changed in size. Changes to the View windows are not automatically saved and are reset to the factory default settings when the software is exited.

#### Hiding, showing and resizing the library panels

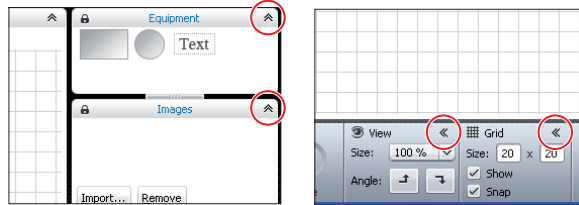

Library panels that show the  or  icon can be minimized and maximized:



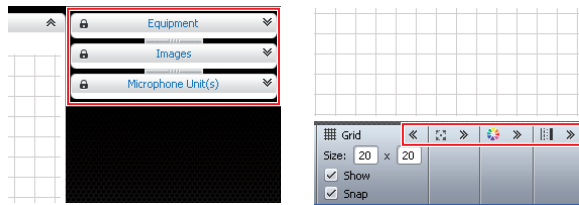

The header of a library panel is always displayed.







To hide a library panel:

- ▶ Click the  or  icon in the header of the library panel that you want to hide.





To show a library panel:

- ▶ Click the  or  icon in the header of the library panel that you want to show.

To change the size of a library panel:



- ▶ Move over the  or  icon between the library panels. The mouse pointer  becomes the resize tool .
- ▶ Adjust the size of the library panel as needed.



The  and the  icons display if the "Equipment", "Images" or "Microphone Unit(s)" library panel is locked () or unlocked () (see page 84).

#### Adjusting the column width of the delegate list

To change the column width of the delegate list:

- ▶ Move the mouse pointer over the header of the delegate list. The mouse pointer  becomes the resize tool .
- ▶ Adjust the column width as needed.



A double-click automatically adjusts the column width to fit the contents.

## Using the full screen mode of the Windows software

- ▶ In the menu bar, click "Edit" > "Full Screen".  
The full screen mode of the software is activated/deactivated.

## Adjusting the screen, mouse, and keyboard settings and the date/time setting of the central unit\*

- ▶ In the menu bar, click "Settings" > "System Properties".  
The "System Properties" window appears.

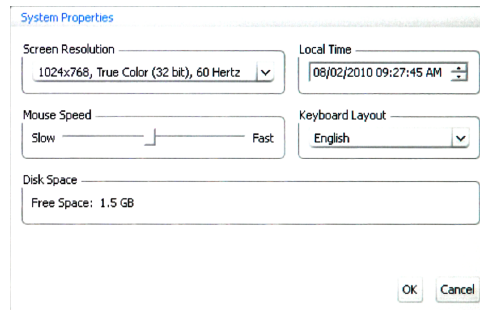

To adjust the screen settings:

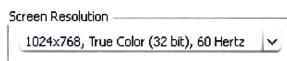

- ▶ Select the desired value from the drop-down list in the "Screen Resolution" box.  
The screen resolution should be at least 800 x 600 pixels (recommended: 1024 x 762 or 1280 x 1024 pixels).



Screen resolutions and refresh rates are automatically adapted to the connected screen so that you can always select the optimum settings for e.g. flat screen monitors or video projectors. It might be necessary to restart the central unit in order to be able to select the optimum settings for your screen.

If the screen connected to the central unit does not show anything, it may be that the screen resolution is set too high. In this case, reset the screen resolution:

- ▶ Press the key combination "CTRL" + "SHIFT" + "F1".  
The screen resolution is reset to 800 x 600 pixels.

To adjust the mouse pointer speed:

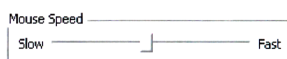

- ▶ In the "Mouse Speed" box, move the slider to
  - "Slow" to reduce the pointer speed or to
  - "Fast" to increase the pointer speed.

To adjust to keyboard layout to the central unit (e.g. cyrillic keyboard layout):

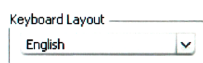

- ▶ Select the desired value from the drop-down list in the "Keyboard Layout" box.

To adjust the date and time of the central unit:

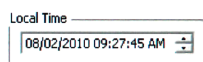

- ▶ Highlight the individual digits in the "Local Time" box.
- ▶ Enter the date and time via the keyboard or click the  buttons to increase or reduce the highlighted digits.
- ▶ Click "OK".  
The settings are saved and the "System Properties" windows closes.

\* only if you are using the central unit's integrated software





The "Disk Space" box in the "System Properties" window provides information on the free memory available on the central unit.

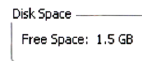

### Selecting the language

- ▶ In the menu bar, click "Settings" > "Language". A list with the available languages appears.
- ▶ Click the desired language. The language of the software is changed.

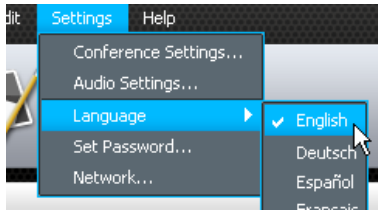

### Protecting configurations with a password and changing a password

### Using a password

You can use a password to protect existing configurations against unauthorized change. This means that all settings adjusted in "Setup" operating mode are locked. However, password-protected configurations can be used in "Live" mode and settings can be adjusted.

- ▶ In the menu bar, click "Settings" > "Set Password...". The "Set Password" window appears.

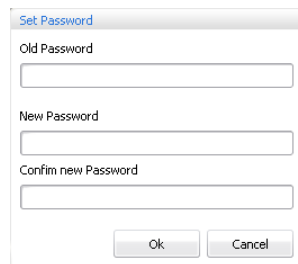

To enter a new password:

- ▶ Leave the "Old Password" field empty.

To change an existing password:

- ▶ Enter the existing password into the "Old Password" field.
- ▶ Enter the new password into the "New Password" and "Confirm new Password" fields. The password can consist of up to 16 characters.



If you do not want to use a password, leave the "New Password" and "Confirm new Password" fields empty.

- ▶ Click "OK". The new password is saved and the configuration is password-protected. Before any changes to the configuration are accepted, you are prompted to enter the password set.



The master key combination allows you to unlock password-protected configurations:

- ▶ Press the key combination "CTRL" + "SHIFT" + "F10". An existing password is deleted.

## Adjusting network settings



If you make changes to the settings in the "Network Settings" window, an existing network connection can be lost!

- ▶ In the menu bar, click "Settings" > "Network...". The "Network Settings" window appears.

To automatically integrate the central unit in a network using a dynamic IP address:

- ▶ Select the "Obtain an IP Address automatically" option button.
- ▶ Click "OK".  
The setting is applied and the "IP Address" and "Subnet mask" fields display the automatically assigned addresses.

To manually integrate the central unit in a network using a static IP address:

- ▶ Select the "Use the following IP Address" option button.
- ▶ Enter the desired IP address into the "IP address" field.
- ▶ Enter the desired subnet mask address into the "Subnet mask" field.

- ▶ Click "OK".  
The setting is applied.



For further information on the network configuration of the conference system, refer to page 52.

## Loading the factory default settings

- ▶ In the menu bar, click "Settings" > "Restore Factory Settings". All software settings are reset to default.



If the screen connected to the central unit does not show anything, it may be that the screen resolution is set too high. In this case, reset the screen resolution:

- ▶ Press the key combination "CTRL" + "SHIFT" + "F1".  
The screen resolution is reset to 800 x 600 pixels.

## Using the conference system and the software

### Connecting the software to the central unit

To connect the "Conference Manager" software to the central unit:

- ▶ Start the software (see page 55).  
The "Open" window appears.

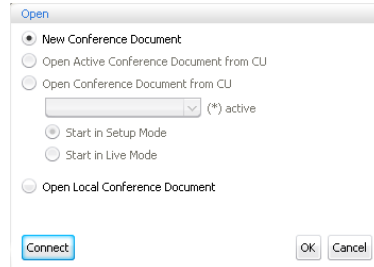

- ▶ Click "Connect".

Or:

- ▶ In the menu bar, click "Global Menu" > "Connect ...".  
The "Connect to CU" window appears, showing a list of available central units.

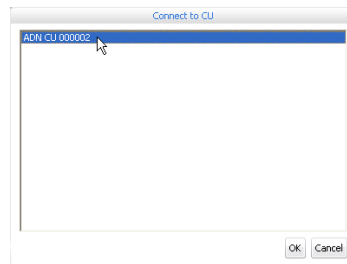

- ▶ Select the desired central unit.



- The "Connect" button is also available in other program windows. Its function is always to connect the "Conference Manager" software to the central unit.
- The Windows version of the software allows you to select different central units in the network. The central unit's integrated software can only be connected to its own central unit.

- ▶ Click "OK".  
The software is connected to the selected central unit. The "Device Connected" icon  appears on the toolbar.

### Eliminating connection problems

If no connection to the central unit can be established or if the configuration cannot be found, an error message appears.

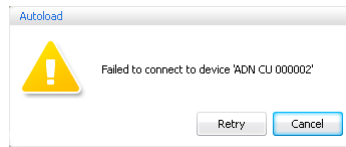

- ▶ Check if the central unit is correctly connected\* (see page 50) and switched on (see page 20).
- ▶ If necessary, disconnect an existing connection to the central unit in order to establish a new connection (see next section).
- ▶ Click "Retry".



### Disconnecting the connection to the central unit

- ▶ In the menu bar, click "Global Menu" > "Disconnect".  
A confirmation prompt appears.
- ▶ Click "OK".  
The connection to the central unit is disconnected. If necessary, the software changes to "Setup" operating mode.

### Creating a new configuration

- ▶ In the menu bar, click "Global Menu" > "New Conference Document".  
The "Open" window appears.

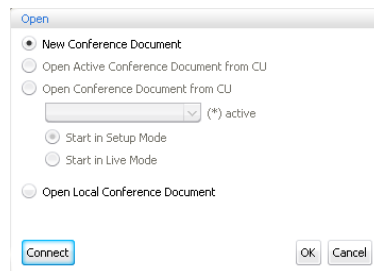

- ▶ Select the "New Conference Document" option button.
- ▶ Click "OK".  
A new configuration is created. The software changes to "Setup" operating mode and the Room View window is displayed (see page 60).

---

\* only if you are using the Windows version of the software

### Loading a configuration

- ▶ In the menu bar, click "Global Menu" > "Open Conference".  
The "Open" window appears.

If the software is connected to a central unit (see page 66), you can load three types of configurations:

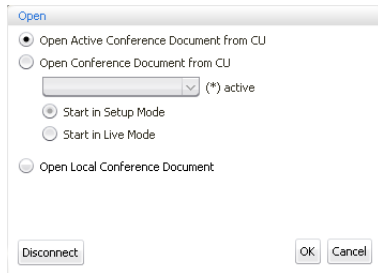

Loading a configuration ...	Actions
... of an active (running) conference ("Active Conference Document")	To load your configuration in "Live" <sup>*</sup> operating mode: <ul style="list-style-type: none"> <li>▶ Select the "Open Active Conference Document from CU" option button.</li> <li>▶ Click "OK".</li> </ul> To select the operating mode ("Setup" <sup>**</sup> or "Live") in which the configuration is to be loaded: <ul style="list-style-type: none"> <li>▶ Select the "Open Conference Document from CU" option button.</li> <li>▶ Select the configuration of an active conference (marked with an asterisk "**") from the drop-down list.</li> <li>▶ Select the operating mode ("Setup" or "Live") and click "OK".</li> </ul>
... of a non-active conference ("Conference Document")	To select the operating mode ("Setup" or "Live") in which the configuration is to be loaded: <ul style="list-style-type: none"> <li>▶ Select the "Open Conference Document from CU" option button.</li> <li>▶ Select the configuration of a non-active conference (not marked with an asterisk "**") from the drop-down list.</li> <li>▶ Select the operating mode ("Setup" or "Live") and click "OK".</li> </ul>
... of a conference saved locally on the hard disk ("Open Local Conference Document") <sup>***</sup>	<ul style="list-style-type: none"> <li>▶ Select the "Open Local Conference Document" option button.</li> <li>▶ Click "OK" and select the desired configuration from the "Open Conference" file selection dialog box (file extension "*.adn").</li> <li>▶ Click "OK". The conference is loaded in "Setup" operating mode.</li> </ul>

- \* After loading a configuration, the conference automatically starts in "Live" operating mode. Also observe the information on page 69.
- \*\* In "Setup" operating mode, you can adapt existing configurations to your needs.
- \*\*\* Only available if you are using the Windows version of the software – even if there is no connection to a central unit.



If you open a configuration in "Setup" operating mode, the password set will be prompted (where applies) (see page 64).

### Activating/deactivating automatic loading of a configuration

To automatically load a saved configuration at startup of the conference system:

- ▶ In the menu bar, click "Global Menu" > "Autoload".  
The "Autoload Properties" window appears.
- ▶ Establish a connection to the central unit (see page 66).
- ▶ Select the "Enable Autoload" option button.
- ▶ Select the desired configuration from the drop-down list.
- ▶ Click "OK".

At the next startup of the conference system, the selected configuration is automatically loaded in "Live" operating mode.

To deactivate automatic loading of a configuration:

- ▶ Select the "Disable Autoload" option button.
- ▶ Click "OK".

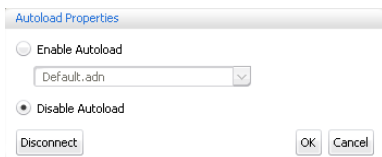
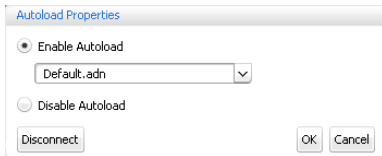

### Saving a configuration

You can save any number of configurations on either the central unit or locally on the connected Windows PC.

To save a newly created configuration on the central unit:

- ▶ In the menu bar, click "Global Menu" > "Save".  
The "Save Conference" window appears.

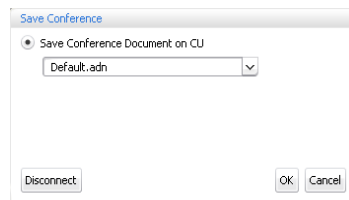

- ▶ If necessary, establish a connection to the central unit (see page 66).
- ▶ Select the "Save Conference Document on CU" option button.
- ▶ Enter a file name into the drop-down list box.
- ▶ Click "OK".

The file is saved on the central unit.

You can click "Global Menu" > "Save" to save a configuration that already has a file name; there is no further query.



Settings made in "Live" operating mode or via the central unit's operating menu are immediately saved to the current configuration.

To protect your configuration, we recommend that you save it under a different file name **before** changing to "Live" operating mode:

- ▶ Make sure that the software is connected to the central unit (see page 66).
- ▶ Load the active configuration in "Setup" operating mode (marked with an asterisk "\*", see page 68).  
This configuration contains the last settings used.
- ▶ Save the configuration under a different file name (see above).

To save a newly created configuration on the hard disk of the Windows PC:

- ▶ In the menu bar, click "Global Menu" > "Save".  
The "Save Conference" window appears.

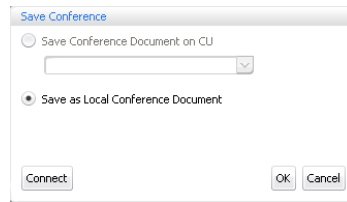

- ▶ Select the "Save as Local Conference Document" option button.
- ▶ Click "OK".  
The "Save conference" window appears.

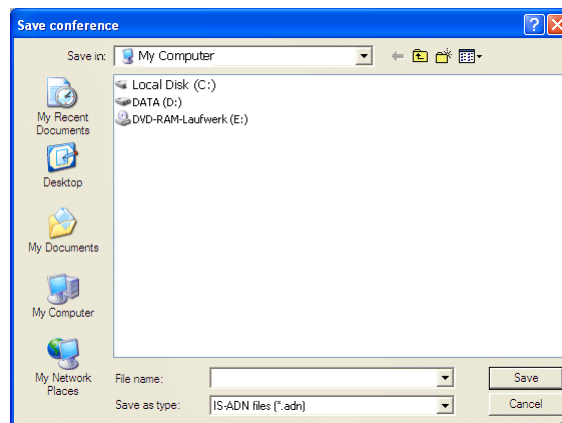

- ▶ Select the desired storage location.
- ▶ Enter a new file name into the "File name" field.
- ▶ Click "Save".  
The file is saved.



- By default, the configurations are saved in the "My Documents/ADN/Conference Files" folder.
- You can click "Global Menu" > "Save" to save a configuration that already has a file name; there is no further query.

### Saving a configuration under a different file name

To save the current configuration under a different file name:

- ▶ In the menu bar, click "Global Menu" > "Save as ...".  
The "Save Conference" window appears.

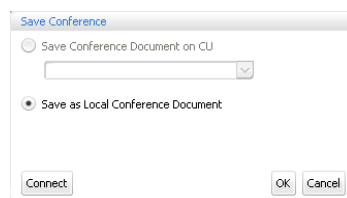

- ▶ Save the current configuration under a different file name (see page 69).

### Closing a configuration

- ▶ In the menu bar, click "Global Menu" > "Close".  
The configuration is closed.

### Deleting a configuration from the central unit

- ▶ In the menu bar, click "Global Menu" > "Delete".  
The "Delete Conference" window appears.

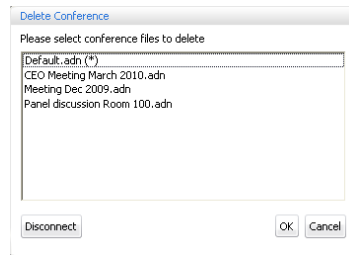

- ▶ Select a configuration.
- ▶ Click "OK".  
After a confirmation prompt, the selected file is deleted.



Configurations saved on the hard disk of a PC can be deleted using the Windows Explorer.



## Preparing a conference and mapping a conference room – "Setup" operating mode

In "Setup" operating mode, you can use photos and graphical elements to map a conference room. Using delegate lists, you can clearly assign conference units to conference participants and then monitor and control your conference.

Example of a photographical representation of the conference room (see page 78):



Example of a graphical representation of the conference room (see page 74):

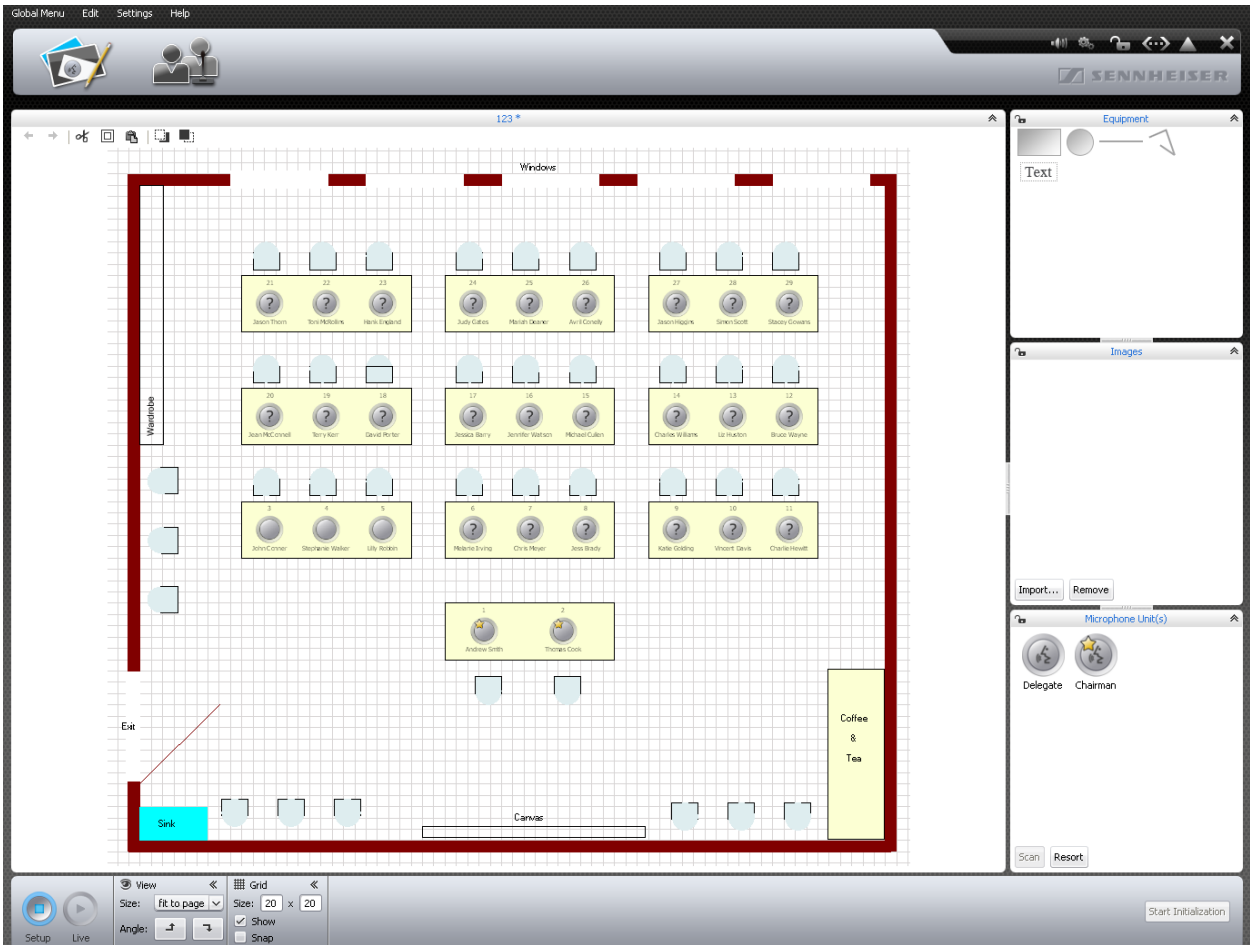

Example of a delegate list (see page 85):

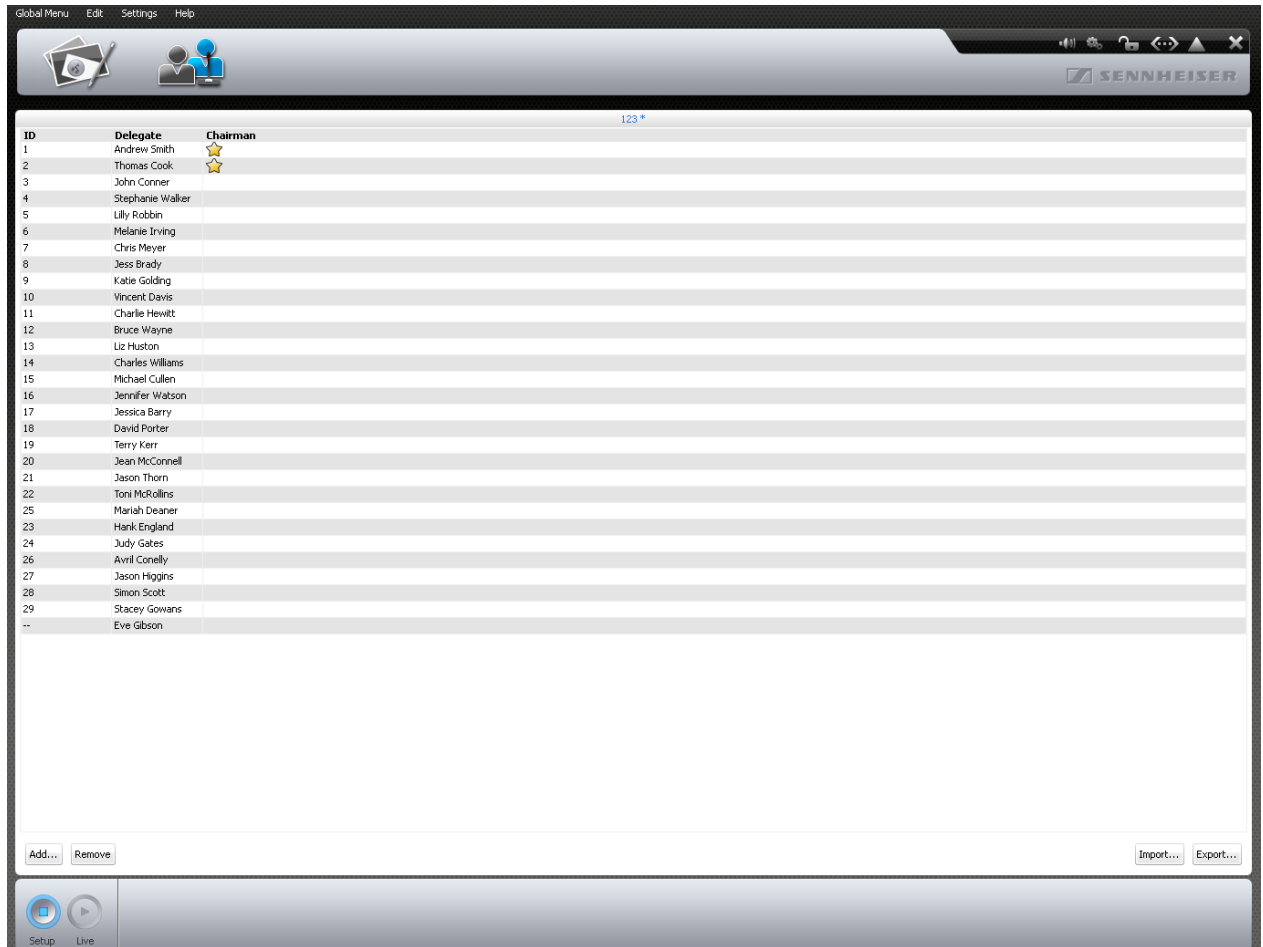



### Planning and mapping the conference room

Placing objects on the canvas

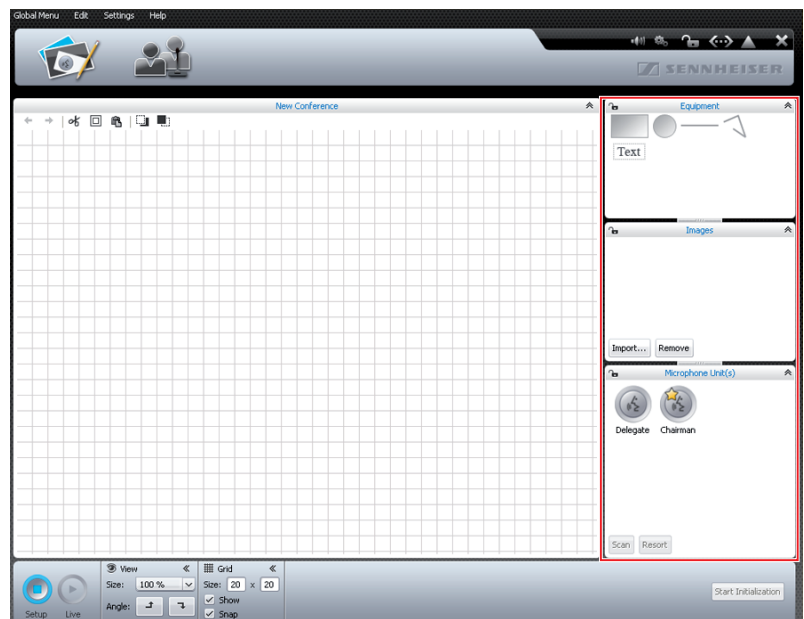
▶ Click the Room View button 



- ▶ Select an object from the "Equipment", "Images" or "Microphone Unit(s)" library panels. The selected object is highlighted in blue.
- ▶ Drag the object onto the canvas.  
If the object can be dropped at the current cursor position, the object and the  icon are displayed next to the mouse pointer. If the object cannot be dropped at the current cursor position, the  icon is displayed.
- ▶ Drop the object at the desired position.  
The object is placed on the canvas in standard size.



You can also place rectangles and circles as follows:

- ▶ Right-click the desired object.  
The context menu of graphic objects appears.
- ▶ Click "Add".  
The object is placed in the center of the canvas.



You can predefine the color and border of the graphic objects so that the placed objects already have the desired properties (see "Defining fill, line and border attributes" on page 77).

#### Creating and positioning a freeform path

- ▶ In the "Equipment" library panel, select the Freeform Path tool and place it on the canvas (see page 74).  
The starting point of the freeform path is set.
- ▶ Use mouse clicks to add anchor points to the freeform path.
- ▶ Double-click the last anchor point of the path.  
The freeform path is complete.



#### Placing several objects on the canvas

To place several rectangles or circles on the canvas:

- ▶ Right-click the desired object.  
The context menu of graphic objects appears.
- ▶ Click "Add Multiple...".  
The "Add Equipment" window appears.

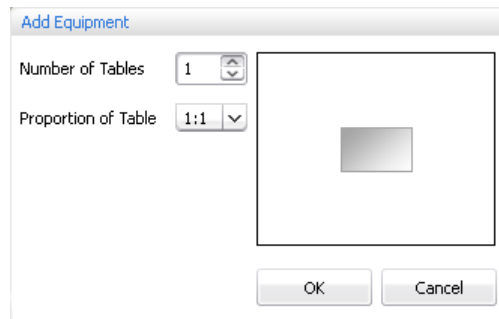

Number of Tables



- ▶ Enter the desired number of rectangles or circles into the "Number of Tables" field.

- ▶ Select the shape of the rectangles or circles from the "Proportion of Table" drop-down list.  
The thumbnail displays the selected shape.

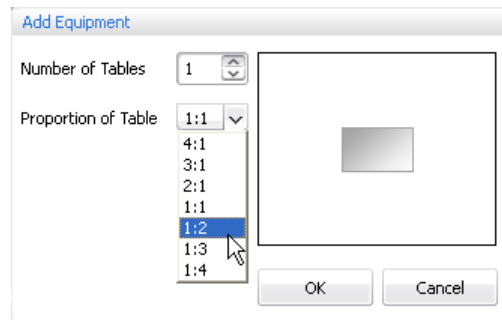

- ▶ Click "OK".  
The desired number of rectangles or circles is placed on the canvas.



Newly placed objects can cover existing objects. In this case, change the order of the objects by sending them to the front or back (see page 81).

#### Moving graphic objects

- ▶ Select the desired object on the canvas.  
The object appears with a bounding box (dotted line) around it. Objects that cannot be selected are locked (see page 84).
- ▶ Move the object to the desired position.



If you want to move several objects simultaneously, position the mouse pointer on the canvas, then click and hold down the left mouse button while you draw a box around the objects to be moved. Alternatively, hold down the "CTRL" key and click the desired objects one after the other.

You can also select all objects on the canvas by clicking "Edit" > "Select all" in the menu bar (or by pressing the key combination "CTRL" + "a").

Use the grid lines to align the objects (see page 83).

#### Resizing graphic objects

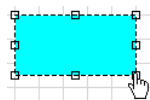

- To resize rectangles, circles, lines or paths:
- ▶ Select the desired object on the canvas.  
The object appears with a bounding box (dotted line) and bounding box handles around it.
  - ▶ Place the mouse pointer on the desired bounding box handle.  
The mouse pointer changes to a hand icon.
  - ▶ Resize the object as needed.

#### Rotating objects

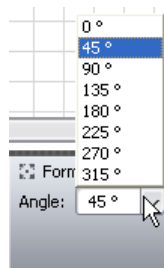

- ▶ Select the desired object on the canvas.  
The selected object is outlined with a dotted line. The "Form" box appears.
  - ▶ Select the desired rotation angle from the "Angle" drop-down list.
- Or:
- ▶ Enter the desired rotation angle into the "Angle" drop-down list box.

### Defining fill, line and border attributes

Please note when defining fill, line and border attributes:

If you select an object **in the library panel** and then define fill, line and border attributes, the defined attributes apply to all newly created objects of this type.

If you select an object already placed **on the canvas** and then define fill, line and border attributes, the defined attributes only apply to the selected object on the canvas.

### Defining the fill color



To define the fill color:

- ▶ Select the object.
- ▶ Click the "Fill" button.  
The list of colors appears.
- ▶ Select a standard color.

Or:

- ▶ Click the **...** button.  
The "Select color" window appears.
- ▶ Select an individual color.
- ▶ Click "OK".  
The fill color is assigned to the selected object or to all newly created objects (see above).

To add an individual color to the list of standard colors:

- ▶ Select the desired color in the "Select color" window.
- ▶ Click "Add to Custom Colors".  
The color is added to the list of standard colors.

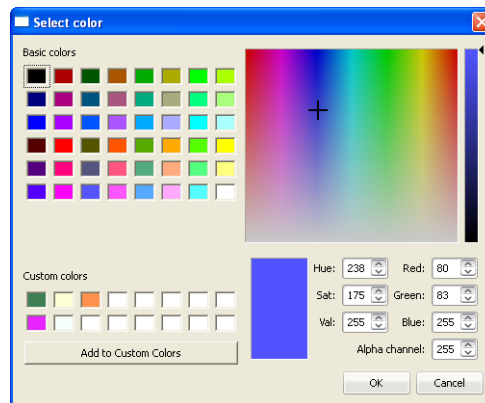

### Changing the line and border style and color

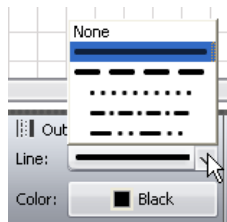

To define the line or border style:

- ▶ Select the object.
- ▶ Click on the "Line" drop-down list.  
The list of available line styles appears.
- ▶ Select a line type.  
The line style is assigned to the selected object or to all newly created objects (see above).

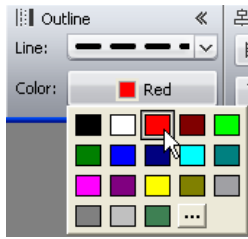

### Placing text on the canvas



### Changing the font type

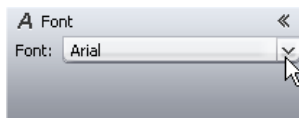

### Changing the font size

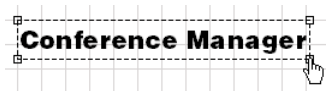

### Using image files

To define the line color:

- ▶ Select the object.
- ▶ Click the "Color" button.
- ▶ Select a standard color.

Or:

- ▶ Click the "...".  
The "Select color" window appears.
- ▶ Select a color.
- ▶ Click "OK".

The line or border color is assigned to the selected object or to all newly created objects (see "Defining fill, line and border attributes" on page 77).

- ▶ Select the "Text" Text Object tool in the "Equipment" library panel and drag it onto the canvas.  
The text object is placed on the canvas.

- ▶ Double-click the text object.

- ▶ Enter the desired text.

- ▶ Select the desired text object on the canvas.

The text object appears with a bounding box (dotted line) around it. The "Font" box appears.

- ▶ Select the desired font from the "Font" drop-down list.  
The font of the text object is changed.



If a configuration file uses a font not installed on the central unit, this font is automatically replaced with the "Microsoft Sans Serif" font.

- ▶ Select the desired text object on the canvas.

The text object appears with a bounding box (dotted line) and bounding box handles around it.

- ▶ Place the mouse pointer on the desired bounding box handle.  
The mouse pointer changes to a hand icon.

- ▶ Drag the bounding box handle to resize the font size.

To particularly realistically simulate the conference situation, you can import image files of your conference room into the software. You can then position conference unit icons exactly where the conference participants are seated and you can also position pictures of the participants or company logos.



Image files can only be imported when you are using the Windows version of the software (see next page).

- ▶ Click the "Room View" button .

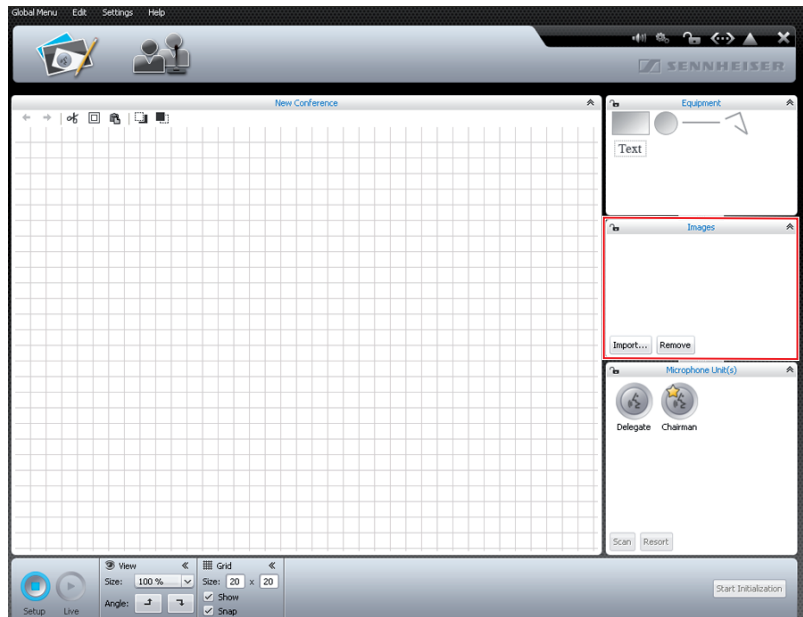

To add an image file<sup>\*</sup>:

- ▶ In the "Images" library panel, click "Import...". The "Import..." window appears.
- ▶ Select an image file (file extension: "jpg", "png" or "bmp").
- ▶ Click "OK".

The selected image file is added to the library. If you save the configuration on the central unit (see page 69), all image files are copied and are then also available on the central unit. Image files with a resolution of more than 2048 pixels in width are automatically reduced to 2048 pixels.

The picture of the conference room should meet the following requirements:

- Each seat should be clearly visible.
- Each seat should have enough space for a conference unit icon.
- Use the perspective on the conference room that the conference manager, e.g. the chairman, will have.
- If possible, use a bird's-eye perspective, providing the conference manager with a good view of the conference room.
- Avoid using dark pictures so that the conference unit icons are always clearly visible on the screen.



Please note that the memory space on the central unit is limited (approx. 2 GB). To save memory space, delete image files that are no longer needed.

By default, the image files are saved in the "My Documents/ADN/Images" folder.

To remove image files from the "Images" library panel<sup>\*\*</sup>:

- ▶ Select an image file.
- ▶ Click "Remove".

\* only if you are using the Windows version of the software

\*\* only if the library of the current configuration contains image files



- Automatically aligning objects ► Hold down the "CTRL" key and select several objects on the canvas using the mouse. The objects appear with a bounding box (dotted line). The "Alignment" box appears.

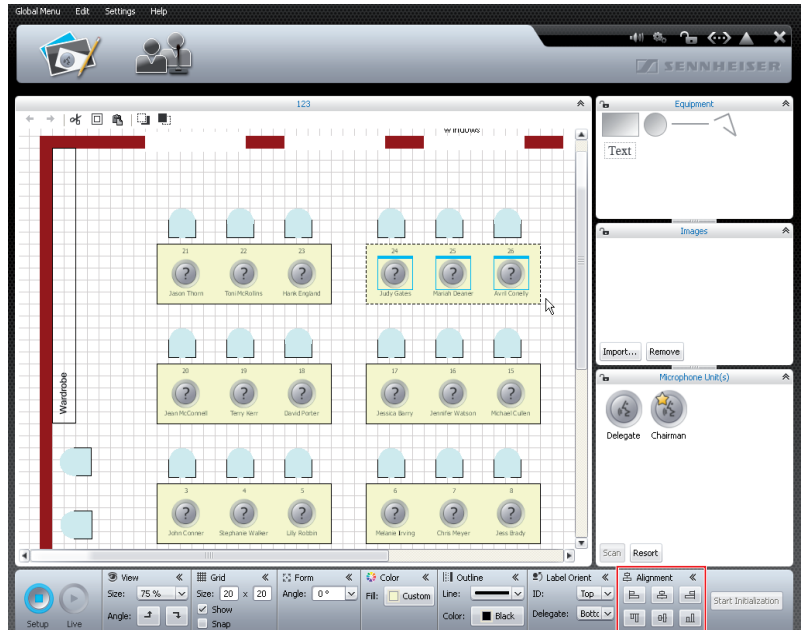

- In the "Alignment" box, click one of the following buttons:

Button	Objects are aligned to the ...
	left edge
	horizontal center
	right edge
	top edge
	vertical center
	bottom edge

The objects are aligned.

## Undoing/redoing actions



- ▶ Click the Room View button .

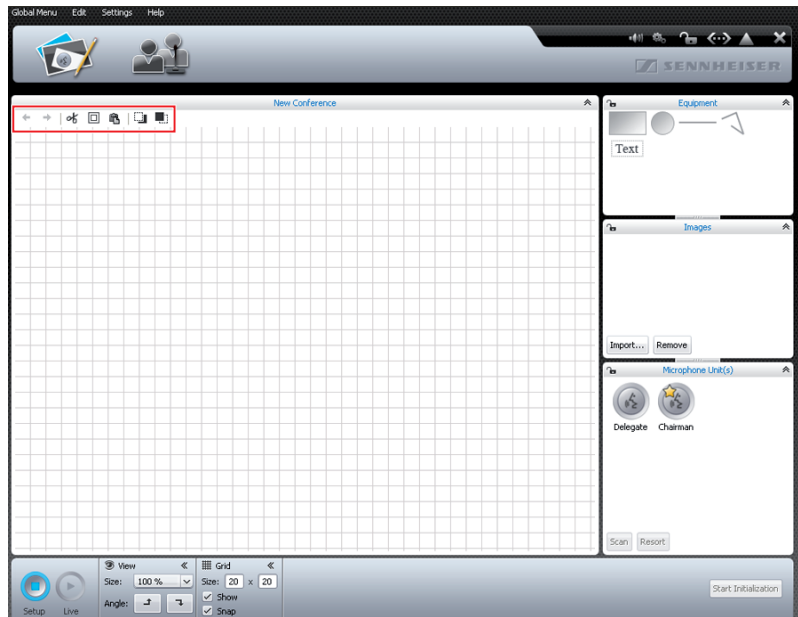

To reverse the last action you performed:



- ▶ Click the ← icon.

To reserve the last "undo" action:

- ▶ Click the → icon.



You can undo and redo up to 10 actions.

## Copying/pasting/cutting objects



To cut an object and paste it to the clipboard:

- ▶ Select the object that you want to cut and paste.
- ▶ Click the ✂ icon.  
The selected object is cut from the canvas and pasted to the clipboard.

To copy an object to the clipboard:

- ▶ Select the object that you want to copy.
- ▶ Click the ☐ icon.  
The selected object is copied to the clipboard.

To paste an object from the clipboard:

- ▶ Click the 📄 icon.  
The object from the clipboard is pasted to the canvas.

To delete an object:

- ▶ Select the object that you want to delete.
- ▶ Press the "Del" key.  
The selected object is deleted.

## Moving objects forwards/backwards



All objects on the canvas are placed on top of each other.

To move an object backwards:

- ▶ Select an object.
- ▶ Click the 📄 icon.  
The selected object is moved backwards.

To move an object forwards:

- ▶ Select an object.
- ▶ Click the  icon.  
The selected object is moved forwards.

### Enlarging the canvas

When a new conference document opens in the Room View window, the canvas is the large area with the grid pattern. When you reduce the size of the canvas, you can see that the grid lines of the canvas are surrounded by a white area.

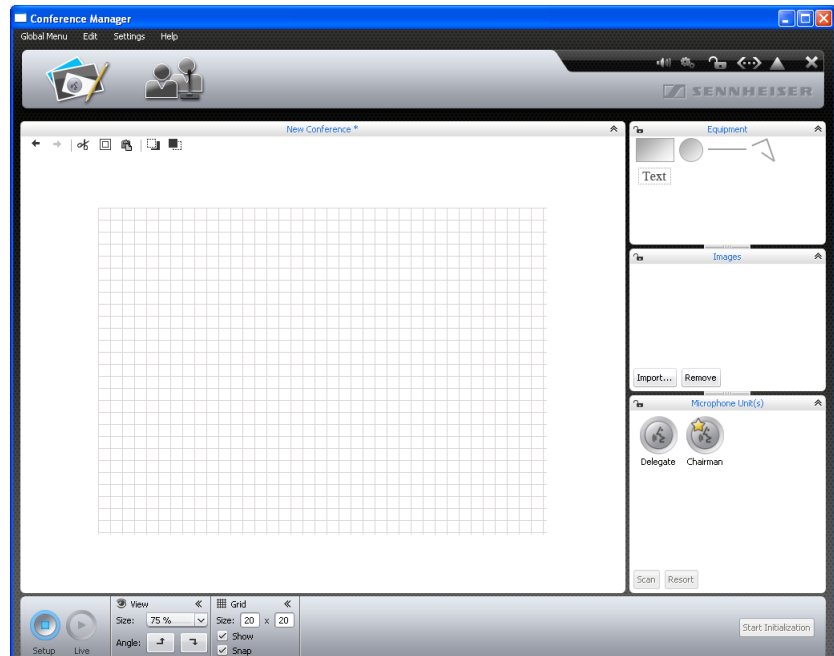

To enlarge the canvas:

- ▶ Move any objects on the canvas beyond the area of the grid lines.  
The canvas is automatically enlarged and adjusted to the new position of the objects.



When you remove objects from the enlarged area of the canvas, the canvas is reduced to its normal size.

Changing the size of the canvas ▶ Click the Room View button .

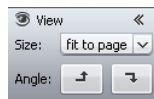
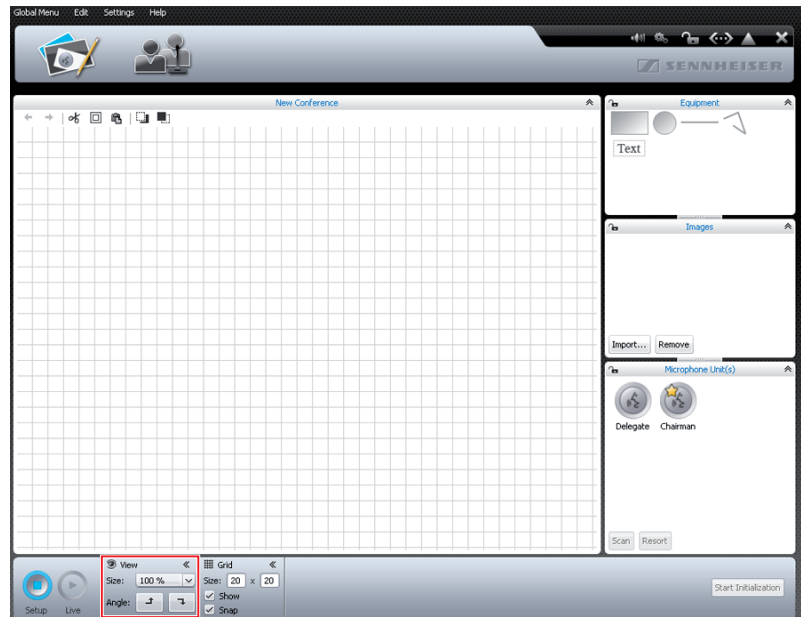

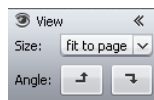

To enlarge/reduce the size of the canvas:

- ▶ Select the desired scaling factor from the "Size" drop-down list. The size of the canvas is adjusted.



To rotate the contents of the canvas:

- ▶ Click  or . The contents of the canvas is rotated by 90°.



When the contents of the canvas is rotated, the orientation of the text objects does not change so that the text remains readable.

Using grid lines ▶ Click the Room View button .

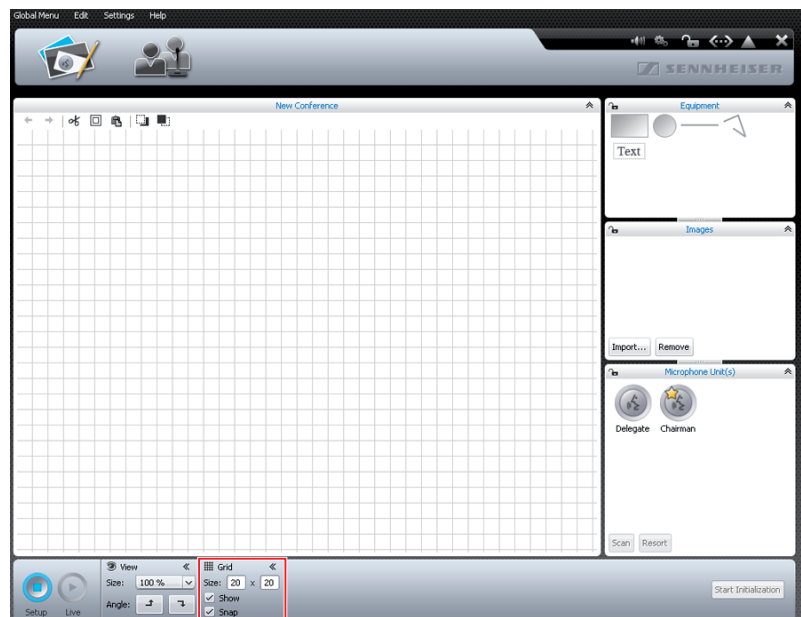

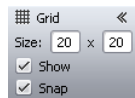

To show/hide the grid lines:

- ▶ Tick/untick the "Show" check box.

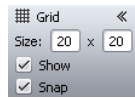

To adjust the grid size:

- ▶ Enter the desired grid size (between 1 and 99) into the "Size" fields. The grid size is adjusted.

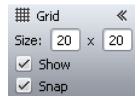

To automatically align objects to the grid when you drop them on the canvas:

- ▶ Tick the "Snap" check box.



If the "Snap" check box is ticked, objects are also aligned to the grid when the grid is invisible.

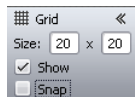



To randomly place objects on the canvas:

- ▶ Untick the "Snap" check box. All objects can be randomly placed on the canvas.

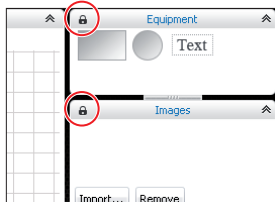

### Locking objects and library panels



You can lock all objects in the "Equipment", "Images" and "Microphone Unit(s)" library panels. In doing so, you also lock all objects placed on the canvas so that they cannot be edited.

- ▶ Click the Room View button .
- ▶ Click the  icon in the header of the library panel that you want to lock. The library panel and the objects are locked (lock icon ). You can no longer drag objects from the library panel to the canvas or edit objects that are already placed on the canvas.

To unlock library panels:

- ▶ Click the  icon in the header of the library panel that you want to unlock. The library panel and the objects are unlocked (lock icon .

## Managing delegate data

## Creating a delegate list

- ▶ Click the Delegate View button . The Delegate View window appears (the screenshot below shows the Windows version of the software which features the additional buttons "Import" and "Export").

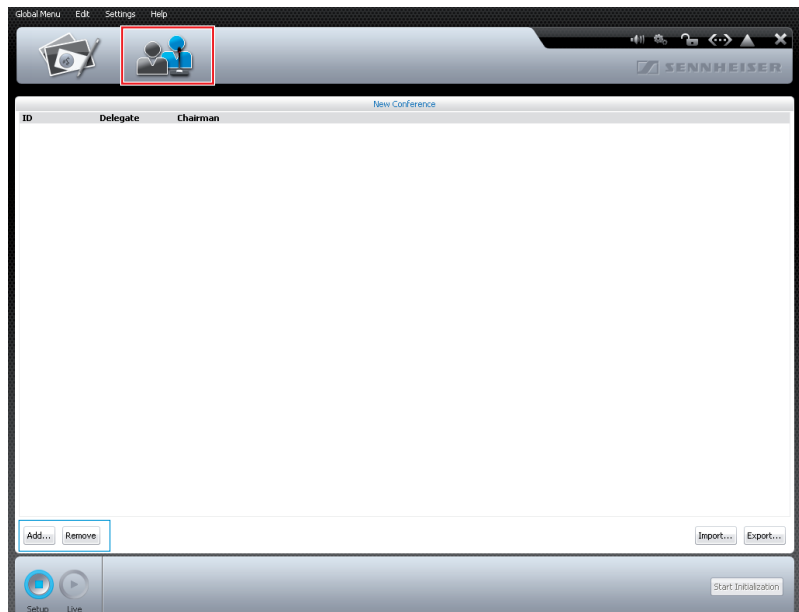

- ▶ Click the "Add..." button. The "Add Delegate" window appears.

- ▶ Enter the delegate name into the "Name" field.
- ▶ Click "OK". The "Add Delegate" window closes and the delegate name is displayed in the "Delegate" column.

ID	Delegate	Chairman
--	Stephanie Walker	

## Changing a delegate name

- ▶ Double-click a delegate name. The "Add Delegate" window appears, displaying the corresponding delegate name.
- ▶ Change the name.
- ▶ Click "OK". The "Add Delegate" window closes.

## Deleting a delegate name

- ▶ Select a delegate name.
- ▶ Click the "Remove" button. The delegate name is deleted from the delegate list.

## Exporting a delegate list\*

- ▶ Click the "Export ..." button. The "Save as ..." window appears.

\* only if you are using the Windows version of the software

- ▶ Enter a file name.
- ▶ Select the desired storage location.
- ▶ Click "OK".  
The window closes and the delegate list is exported as an XML file.



By default, the delegate lists are saved in the "My Documents/ADN/Delegates Lists" folder.

#### Importing delegate lists\*

You can import delegate lists from other configurations:

##### CAUTION Loss of delegate names

If you import a delegate list, all existing delegate names will be deleted. This action cannot be reversed.

- ▶ Export the existing delegate list to save the data for later use (see above).



- ▶ Click the "Import..." button.  
The "Import Participant Data" window appears.
- ▶ Select the XML file with the delegate list.
- ▶ Click "OK".  
The window closes and the delegate names are displayed in the "Delegate" column.

## Initializing the conference units – "Setup" operating mode

In order to assign the conference units connected to the central unit to the conference unit icons in the software, you have to initialize the conference units. By initializing the conference units, you can clearly label the icons and assign them to certain seats or certain conference participants.

#### Overview of the conference unit icons

The icons display the current status of the conference units. The icons of chairman units are marked with a star.

Conference unit icon	Meaning
	The icon has not yet been assigned a conference unit. The conference unit is not ready for operation.
	The icon has been assigned a conference unit. The conference unit is ready for operation.

#### Placing conference units on the canvas and initializing them

You can automatically or manually place conference units on the canvas and initialize them.

#### Automatic placement and initialization of conference units

- ▶ Set up the conference system (see page 17).
- ▶ Establish a connection between the "Conference Manager" software and the central unit (see page 66).

\* only if you are using the Windows version of the software

- ▶ Click the Room View button .

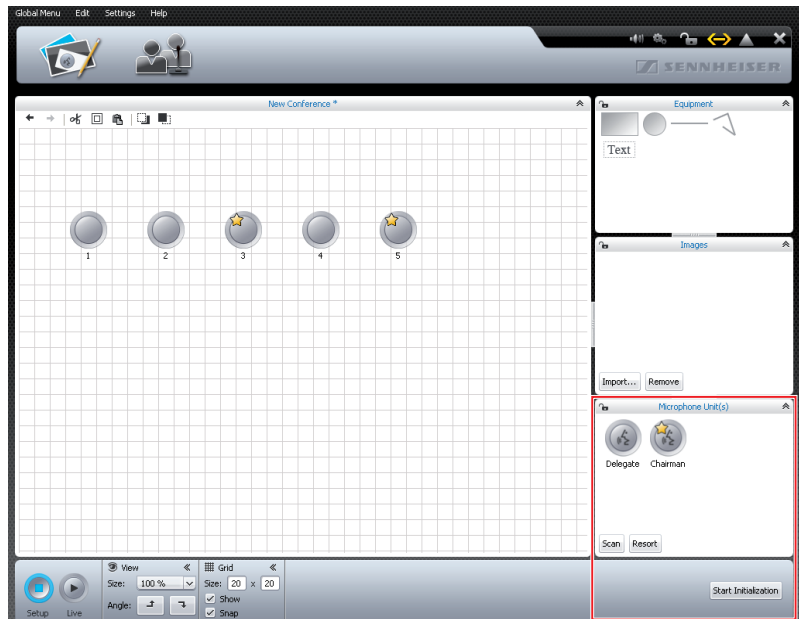

- ▶ In the "Microphone Unit(s)" library panel, click the "Scan" button. The conference unit icons are placed on the canvas and initialized in the order which corresponds to the physical order of connection to the central unit. The sequential number of the conference units is displayed below the conference unit icons. The icons of chairman units are marked with a star.

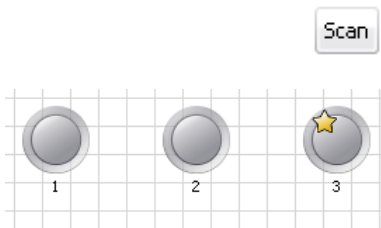

**i** If there are already conference unit icons on the canvas, a confirmation prompt appears, telling you that these icons will be deleted. If you do not want to delete these icons, you have to manually place and initialize the conference units (see next section).

Manual placement of conference units



To manually place conference units on the canvas, the software must not be connected to the central unit.

- ▶ In the "Microphone Unit(s)" library panel, select a delegate unit icon or a chairman unit icon and drag it on the canvas (see page 74). The sequential number of the conference unit is displayed below the icon. As long as the conference units are not yet initialized, a question mark is displayed on the icon.



To enable manually placed conference units for use:

- ▶ Assign each icon on the canvas a conference unit that is connected to the central unit (see "Starting/stopping initialization of the conference units" on page 88).

**i** If you only want to select and edit conference unit icons, you can lock the graphic objects and pictures that are in the background (see page 84).



### Starting/stopping initialization of the conference units

Start Initialization

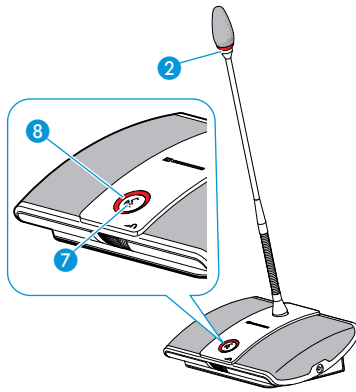

Stop Initialization

To start the initialization of the conference units:

- ▶ Click the "Start Initialization" button and confirm the confirmation prompt with "OK".

The microphone LEDs 8 and the signal light rings 2 of the connected conference units light up red. The conference unit icon with the number "1" is permanently marked with a red circle. All other icons are marked with flashing red circles.

To assign a conference unit to the conference unit icon which is permanently marked with a red circle:

- ▶ Press the microphone key 7 on the conference unit. The microphone LED 8 and the signal light ring 2 of the conference unit go off. The next conference unit icon is permanently marked with a red circle.
- ▶ Repeat this step for the remaining conference units. The initialization process is complete when all conference units are assigned.



You can only assign delegate units to delegate unit icons and chairman units to chairman unit icons.

To stop the initialization of the conference units:

- ▶ Click the "Stop Initialization" button in the "Microphone Unit(s)" library panel. The initialization is stopped. All conference units that have not been initialized are marked with a question mark. If you continue the initialization, you have to assign all conference units again.

### Changing the numbering of the conference units

Resort

To change the numbering of the conference units:

- ▶ Click the "Resort" button. The "Resort" button becomes the "Stop Resort" button.
- ▶ Click the conference unit icons in the desired order. The numbering of the conference unit icons is changed.



If, during numbering, you realize that you require further conference unit icons, just place them on the canvas. The numbering process is not interrupted.

Stop Resort

To stop the numbering of the conference units:

- ▶ Click the "Stop Resort". The changes made are retained.

To change the numbering of individual conference units:

- ▶ Select a conference unit icon. The selected icon is marked with a blue rectangle and the "Microphone Unit" box appears.
- ▶ Enter the desired number into the "ID" field. The number of the conference unit icon is changed and the numbering of the other conference unit icons is automatically adjusted.

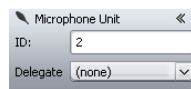

### Assigning delegate names to the conference units

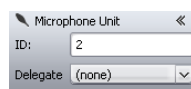

- ▶ Create a delegate list (see page 85).

- ▶ Select a conference unit icon. The selected icon is marked with a blue rectangle and the "Microphone Unit" box appears.

- ▶ Select the desired name from the "Delegate" drop-down list. The name is assigned to the conference unit and is displayed below the icon. The conference unit assigned to the name appears in the "ID" column of the Delegate View window.

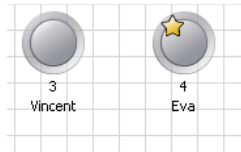

ID	Delegate	Chairman
4	Eva	★
3	Vincent	
--	Thorsten	
--	Marina	
--	Roland	
--	Petra	

### Changing the orientation/visibility of the icon labeling

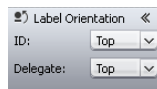

You can change the orientation/visibility of numbers and delegate names assigned to the conference unit icons:

- ▶ Select a conference unit icon. The selected icon is marked with a blue rectangle and the "Label Orientation" box appears.

To change the orientation/visibility of the number:

- ▶ Select the desired orientation from the "ID" drop-down list. The number is displayed at the selected side of the icon or is hidden.

To change the orientation/visibility of the delegate name:

- ▶ Select the desired orientation/visibility from the "Delegate" drop-down list. The delegate name is displayed at the selected side of the icon or is hidden.

Setting	Orientation/visibility
"Left"	left
"Top"	top
"Right"	right
"Bottom"	bottom
"Hidden"	hidden

## Adjusting the conference settings – "Setup" operating mode

### Adjusting the conference mode

- ▶ Click the  button on the toolbar. The "Conference Settings" window appears.

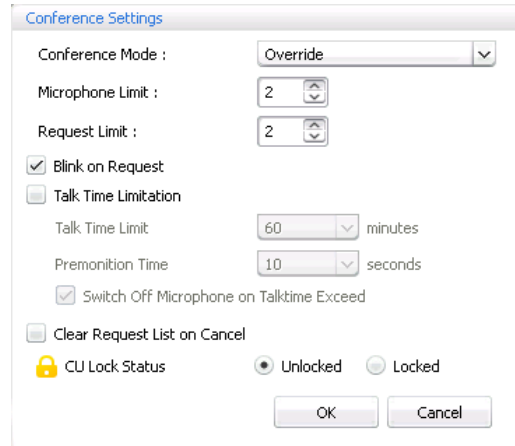

### Adjusting the conference mode

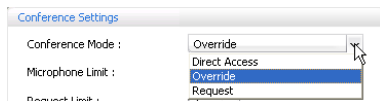

- ▶ Select the desired conference mode from the "Conference Mode" drop-down list.

Possible settings: "Direct Access", "Override" and "Request".

- "Direct Access" mode and "Override" mode:

These two conference modes do not require the use of a chairman unit.

If the maximum number of speakers who can take the floor simultaneously ("Microphone Limit") has not been reached, a further speaker can take the floor immediately.

<b>Situation</b>	The maximum number of speakers who can take the floor simultaneously ("Microphone Limit") has been reached.
<b>Event</b>	A further speaker presses the microphone key on his or her conference unit.
<b>Behavior</b>	In "Direct Access" mode: The speaker has to wait until one of the current speakers passes on or loses his or her speaking privileges. He or she is then automatically granted speaking privileges.  In "Override" mode: The speaker can take the floor immediately. The speaker with the longest speaking time loses his or her speaking privileges.

- "Request" mode:

For this mode to function, a chairman unit is required.

In "Request" mode, the chairman receives requests to speak and grants speaking privileges according to the FIFO principle (First In – First Out), i.e. the speaker with the longest waiting time is granted speaking privileges.

<b>Situation</b>	The maximum number of requests to speak has been reached ("Request Limit").
<b>Event</b>	A further speaker makes a request to speak.
<b>Behavior</b>	The speaker can only make a request to speak if the maximum number of requests to speak drops below the specified limit value.

### Setting the max. number of speakers who can take the floor simultaneously

In the "Microphone Limit" field, you can set the max. number of speakers who can take the floor simultaneously in all conference modes. Please note that any connected chairman unit is counted against the microphone limit. If you set a higher value (adjustment range "1" ... "10") than the one determined by the number of connected chairman units, the system will reduce the microphone limit to the maximum possible value (see examples in the table).

Chairman units	Possible "Microphone Limit" values
0	"1" - "10"
4	"1" - "5"
10	"0"

For information on how this setting affects your conference, refer to the previous section "Adjusting the conference mode".

Adjustment range: "1" ... "10"

Microphone Limit :

- ▶ Enter the max. number of speakers who can take the floor simultaneously into the "Microphone Limit" field.

### Setting the maximum number of requests to speak

The setting adjusted in the "Request Limit" field becomes effective only if you are using a chairman unit ("Request" mode) or if you have selected "Direct Access" mode.

For information on how this setting affects your conference, refer to the previous section "Adjusting the conference mode" (see page 90).

Adjustment range: "0" ... "10"

Request Limit :

- ▶ Enter the max. number of requests to speak into the "Request Limit" field.

### Activating/deactivating the flashing of the signal light ring ② when a request to speak is made

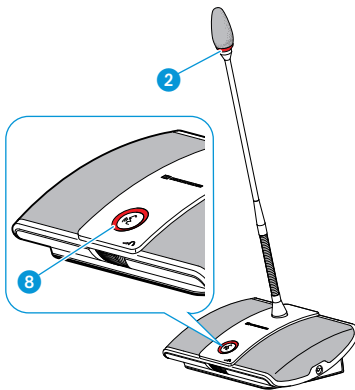

- ▶ Tick/untick the "Blink on Request" check box.

Check box	Behavior when a request to speak is made
is ticked <input checked="" type="checkbox"/> Blink on Request	When a participant makes a request to speak, the microphone LED ⑧ flashes green and the signal light ring ② flashes red.
is unticked <input type="checkbox"/> Blink on Request	When a participant makes a request to speak, the microphone LED ⑧ flashes green.

### Activating/deactivating the speaking time limit

Talk Time Limitation

The "Talk Time Limitation" check box allows you activate/deactivate the speaking time limit. The duration of the speaking time limit, the advance warning time, and the activation of an optical warning signal can be set individually.



If you make a new request to speak, the speaking time countdown is started again.

- ▶ Tick/untick the "Talk Time Limitation" check box.

Check box	Behavior
is ticked <input checked="" type="checkbox"/> Talk Time Limitation	The speaking time is limited to the time period set.
is unticked <input type="checkbox"/> Talk Time Limitation	The speaking time is not limited.

Talk Time Limitation

Talk Time Limit  minut

Premonition Time  secur

Switch Off Microphone on Talktime Exceed

To set the speaking time limit:

- ▶ Enter the speaking time into the "Talk Time Limit" field.

Adjustment range: "1" ... "60", adjustable in steps of 1 minute

To set the advance warning time:

- ▶ Select the desired advance warning time from the "Premonition Time" drop-down list.

Adjustment range: "00" ... "120", adjustable in steps of 10 seconds

This setting affects your conference as follows (example):

"Talk Time Limit" (speaking time limit)	15 (minutes)
"Premonition Time Limit" (advance warning time)	60 (seconds)
Effect	60 seconds before the speaking time limit expires, i.e. after 14 minutes in this example, the signal light ring ② and the microphone LED ⑧ start flashing red.

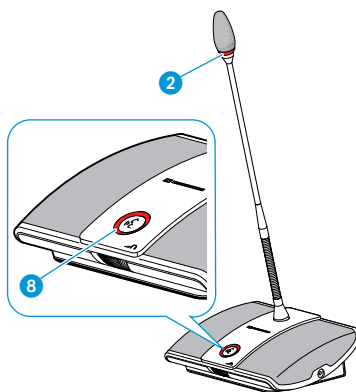

To determine the behavior when the individual speaking time is exceeded:

- ▶ Tick/untick the "Switch off Microphone on Talktime Exceed" check box.

Check box	Behavior of the conference unit when the individual speaking time is exceeded
is ticked	The individual speaking time is terminated.
<input checked="" type="checkbox"/> Switch Off Microphone on	The signal light ring ② and the microphone LED ⑧ go off.
is unticked	The individual speaking time is continued.
<input type="checkbox"/> Switch Off Microphone on	The signal light ring ② and the microphone LED ⑧ flash red until the speaker has finished speaking.

Setting the function of the "All Micros OFF" button



The "Clear Request List on Cancel" check box allows you to set the function of the "All Micros OFF" button (see page 100).

- ▶ Tick/untick the "Clear Request List on Cancel" check box in the "Conference Settings" window.

Check box	Function of the "All Micros OFF" button
is ticked	Deactivates all delegate units and clears a request-to-speak list (if available).
<input checked="" type="checkbox"/> Clear Request List on Can	
is unticked	Deactivates all currently active delegate units. All requests to speak are retained.
<input type="checkbox"/> Clear Request List on Can	

### Locking/unlocking the central unit's operating menu

CU Lock Status     Unlocked     Locked

To protect the central unit's operating menu against any accidental change of settings:

- ▶ In the "Conference Settings" window, select the "Locked" option button behind "CU Lock Status".

The central unit's operating menu is locked. To adjust settings via the operating menu, you have to deactivate the lock mode (see page 21).

To deactivate the lock mode:

- ▶ Select the "Unlocked" option button behind "CU Lock Status". The central unit's operating menu is unlocked.

### Adjusting the audio settings

- ▶ Click the  button on the toolbar. The "Audio Settings" window appears.

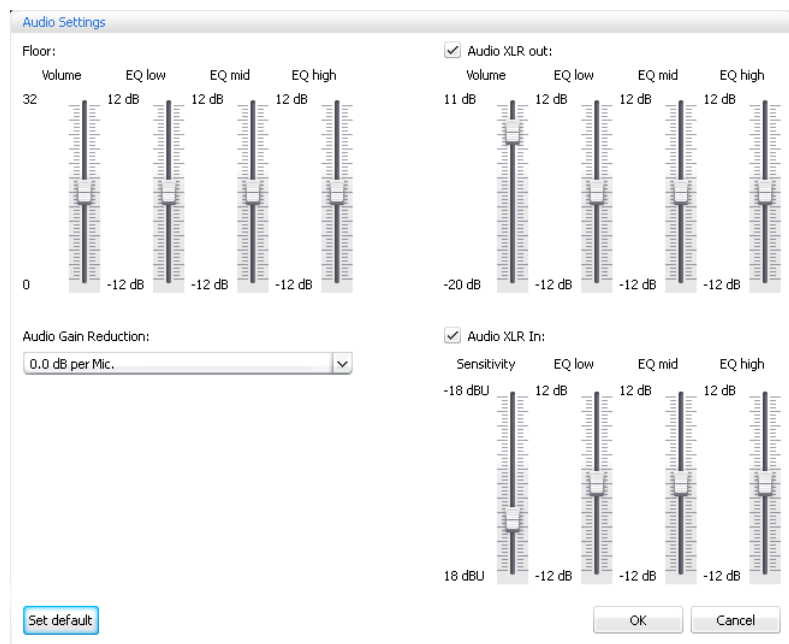

### Setting the volume and the tone color of the floor channel

#### CAUTION



#### Danger of hearing damage due to loud hissing!

When the floor channel volume is set to a high level or when several participants speak simultaneously, feedback noise (loud hissing) can occur. This can cause hearing damage.

- ▶ Reduce the floor channel volume (see page 93 or page 101).
- ▶ Make sure that the "Audio Gain Reduction" function is activated (see page 94). This function reduces the gain per active microphone by the selected level and thus prevents feedback noise.
- ▶ Increase the distance between the individual conference units to at least 50 cm.

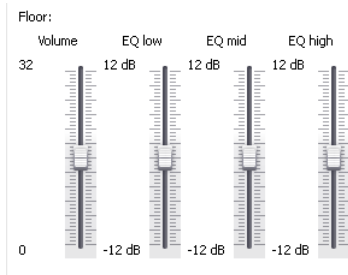

Adjusting the processing of the conference units' audio signals in the floor channel



To set the floor channel volume:

- ▶ Move the "Volume" slider ...
    - ... upwards to increase the floor channel volume or
    - ... downwards to reduce the floor channel volume.
- The floor channel volume is changed immediately.

To set the tone color of the floor channel:

- ▶ Move the "EQ low", "EQ mid" or "EQ high" sliders to change the tone color.
  - ▶ Click "OK".
- Your settings are saved and the "Audio Settings" window closes.

The sum of the audio signals of all conference units is fed to the floor channel which in turn is output via the conference units' built-in loudspeakers and via the OUT audio output. The volume level of the floor channel increases with each additional audio signal\* and tends to overmodulate. The "Audio Gain Reduction" menu item allows you to adjust how the volume levels of the signals of the conference units are processed.

<b>Situation</b>	The audio signal of the 1. conference unit is fed to the floor channel.
<b>Event</b>	The audio signal of another conference unit is fed to the floor channel. The volume level of the floor channel would increase if the signal wasn't influenced.
<b>Behavior</b>	<p><b>"0.0 dB per Mic" ... "-3.0 dB per Mic" setting:</b></p> <p>With each additional audio signal, the volume level of the floor channel is reduced by the adjusted value.</p> <ul style="list-style-type: none"> <li>▶ Try out the different settings by activating the maximum number of open channels (see page 45). The floor channel should be heard at the desired volume level without any distortion or feedback.</li> <li>▶ First start with low values.</li> </ul> <p><b>"Linear Division" setting:</b></p> <p>The volume level of the floor channel is automatically reduced depending on the number of conference units (high gain reduction of the audio signal).</p>

\* conference units and IN audio input

## Using the OUT audio output/IN audio input and setting the tone color

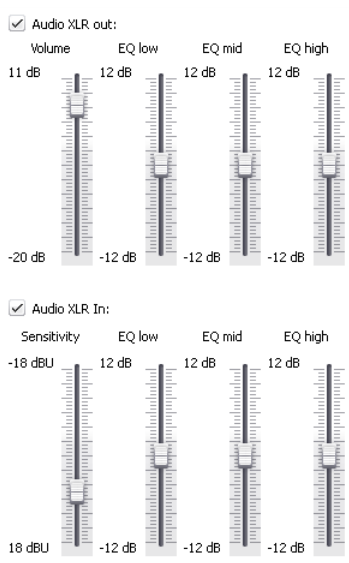

### Resetting the audio settings

Set default

To activate/deactivate the OUT audio output/IN audio input:

- ▶ Tick/untick the "Audio XLR out"/ "Audio XLR In" check box.

The OUT audio output/IN audio input is activated (check box is ticked) or deactivated (check box is unticked).

To set the volume of the OUT audio output/the sensitivity of the IN audio input:

- ▶ Move the "Volume"/ "Sensitivity" slider ...

... upwards to increase the volume/sensitivity or  
... downwards to reduce the volume/sensitivity.  
The volume/sensitivity is changed immediately.

- ▶ Set the sensitivity of the IN audio input so that the audio signal is not overmodulated at maximum input volume (see page 31).

To set the tone color of the OUT audio output/IN audio input:

- ▶ Move the "EQ low", "EQ mid" or "EQ high" sliders to change the tone color.
- ▶ Click "OK".

Your settings are saved and the "Audio Settings" window closes.

To reset the audio settings for the floor channel, the IN audio input and the OUT audio output to the factory default settings:

- ▶ Click the "Set default" button.  
All sliders are reset.

## Controlling and monitoring a conference – "Live" operating mode

In "Live" operating mode, you can:

- control a conference from the screen,
- use either the Room View window or the Delegate View window for controlling the conference,
- use the graphical/photographical representations of the conference room that you created in "Setup" operating mode,
- – with a mouse click – grant or withdraw speaking privileges to/from individual conference units,
- monitor speaking privileges.

### Switching to "Live" operating mode – starting/ending a conference

#### Preparing and starting a conference

- ▶ Load a conference configuration (see page 68).

Or:

- ▶ Prepare a conference in "Setup" operating mode (see page 72).
- ▶ Click the "Live" button.

The "Save Conference" window appears, allowing you to save the configuration on the central unit.

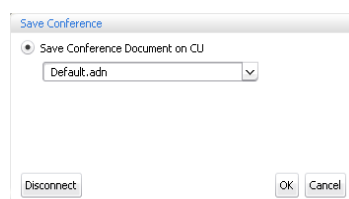





It is vital to observe the information provided in the chapter "Saving a configuration" on page 69.

- ▶ Enter a file name into the drop-down list.
- ▶ Click "OK".  
The configuration is saved on the central unit and "Live" operating mode is started. The View windows change their appearance accordingly and the "Live" button is highlighted in red.

To open the Room View window in "Live" operating mode:

- ▶ Click the Room View button

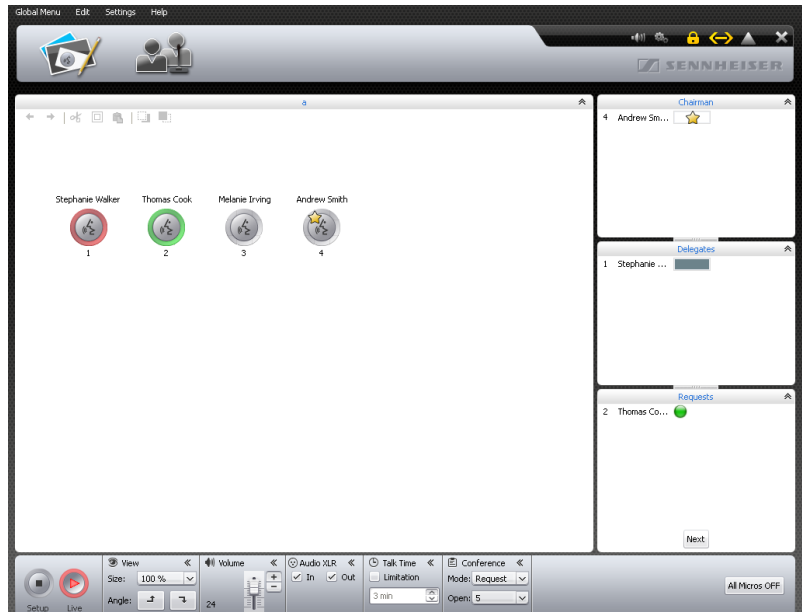

To open the Delegate View window in "Live" operating mode:

- ▶ Click the Delegate View button

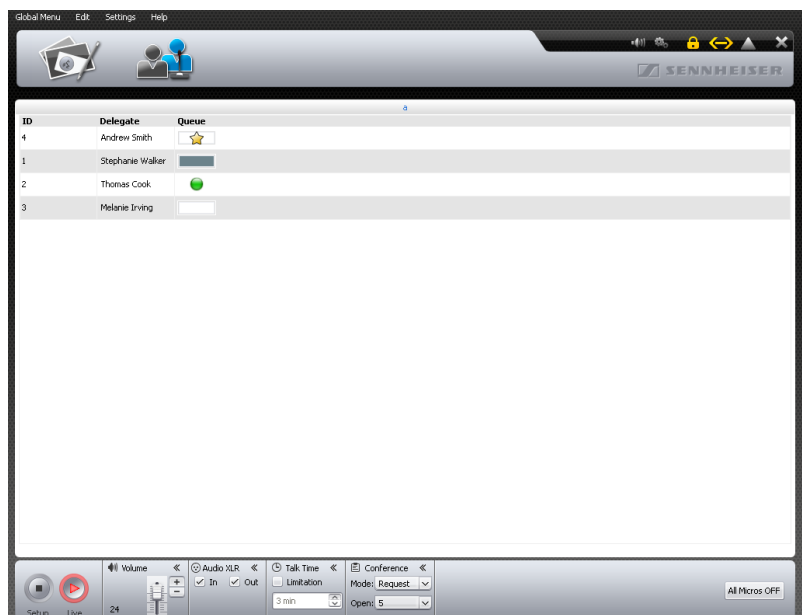

## Using the software for controlling a running conference

If you want to use the software for controlling a running conference:

- ▶ Load the configuration of a running conference (see page 68). The software switches to "Live" operating mode. All active conference units remain active and all requests to speak are retained.



If you have activated automatic loading of a configuration, the configuration is automatically loaded in "Live" operating mode (see page 69).

## Monitoring a conference

You can monitor a conference from the screen without intervening.

## Monitoring a conference using the Room View window

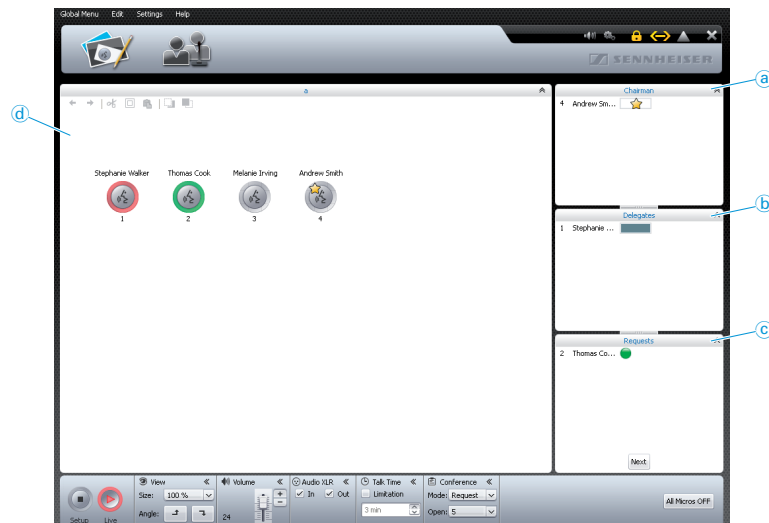

Element	Function/Meaning
(a)	Permanent list of chairman units, sorted by "ID" number
(b)	Delegate units with speaking privileges, sorted by chronological order of registration
(c)	Delegate units that have made a request to speak, sorted by chronological order of registration
(d)	Canvas with initialized conference unit icons

Monitoring a conference using the Delegate View window

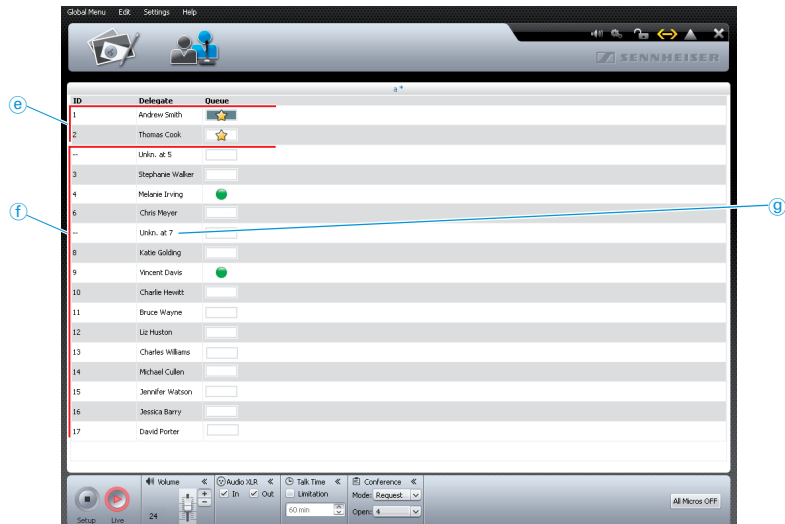

Element	Function/Meaning
e	Permanent list of chairman units, sorted by "ID" number
f	Permanent list of chairman units, sorted by "ID" number
g	Permanent list of uninitialized conference units Designation "Unkn. at 7" ("7" stands for the number of the conference unit which is assigned by order of connection)







Overview of the conference unit icons

The conference unit icons display the current status of the conference units connected to the central unit. The icons of chairman units are marked with a star "★".

Icon	Function/Meaning
	Conference unit icon is not assigned to a conference unit
	Conference unit is ready for operation
	Conference unit with speaking privileges
	Conference unit with speaking privileges, shortly before the speaking time limit expires or when the speaking time limit is exceeded
	Conference unit with speaking privileges but muted (via the priority function of the chairman unit, see page 48)
	Conference unit has made a request to speak

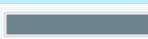
## Overview of the bar graphs

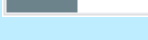
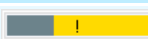
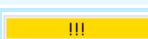
The conference unit icons display the current status of the conference units connected to the central unit.

Bar graph	Meaning
	Chairman unit with speaking privileges
	Chairman unit is deactivated
	Delegate unit with speaking privileges, 100 % of the speaking time is available
	Delegate unit with speaking privileges, approx. 50 % of the speaking time is available
	Delegate unit shortly before the speaking time limit expires
	Delegate unit when the speaking time limit is exceeded
	Delegate unit is deactivated
 flashing	Delegate unit has made a request to speak

## Granting/withdrawing speaking privileges using the Room View window

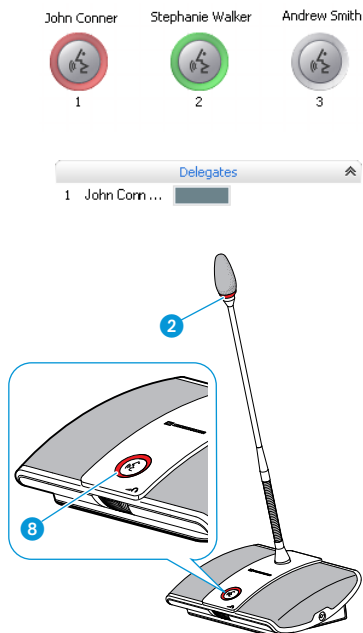

## Controlling a conference

To grant speaking privileges to a conference unit (in all conference modes):

- ▶ Click a conference unit icon.  
The conference unit icon is then marked with a red circle and the conference unit is displayed in the "Delegates" box. The bar graph displays the current status. The conference unit is granted speaking privileges and the signal light ring 2 and the microphone LED 8 light up red.

To withdraw speaking privileges from a conference unit:

- ▶ Click a conference unit icon marked with a red circle.  
The conference unit icon turns grey and the conference unit is removed from the "Delegates" box. The conference unit loses its speaking privileges and the signal light ring 2 and the microphone LED 8 go off.

To arbitrarily grant speaking privileges to a conference unit that has made a request to speak (in "Request" and "Direct Access" mode):

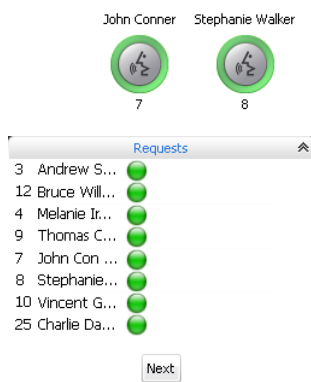

- ▶ Click a green flashing conference unit icon.

Or:

- ▶ In the "Requests" box, click the conference unit to which you want to grant speaking privileges.  
The conference unit is granted speaking privileges (see above) and is removed from the "Requests" box.

Next

Granting/withdrawing speaking privileges using the Delegate View window

ID	Delegate	Queue
3	Andrew Smith	<input type="checkbox"/> ★
7	John Conner	<input type="checkbox"/>
8	Stephanie Walker	<input type="checkbox"/>

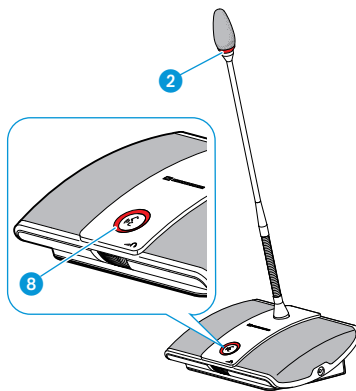

To grant speaking privileges to a conference unit by the order of the request-to-speak list (in "Request" and "Direct Access" mode):

- ▶ Click the "Next" button.  
The conference unit is granted speaking privileges (see above) and is removed from the "Requests" box.

To grant speaking privileges to a conference unit:

- ▶ Click the name of the delegate to whom you want to grant speaking privileges.

The bar graph displays the current status. The conference unit is granted speaking privileges and the signal light ring 2 and the microphone LED 8 light up red.

To withdraw speaking privileges from a conference unit:

- ▶ Click the name of the delegate.  
The bar graph displays that the conference unit is deactivated. The conference unit loses its speaking privileges and the signal light ring 2 and the microphone LED 8 go off.

ID	Delegate	Queue
3	Andrew Smith	<input checked="" type="checkbox"/> ★
7	John Conner	<input type="checkbox"/>
8	Stephanie Walker	<input type="checkbox"/>

To arbitrarily grant speaking privileges to a conference unit that has made a request to speak (in "Request" and "Direct Access" mode):

- ▶ Click the name of the delegate to whom you want to grant speaking privileges.  
The conference unit is granted speaking privileges (see above).

Deactivating all conference units

All Micros OFF

- ▶ Click the "All Micros OFF" button.

The conference system behaves as set.

Depending on the setting (see page 92):

- All LEDs go off and the delegate units are deactivated. A request-to-speak list, if available, is cleared.
- All currently active delegate units are deactivated. All requests to speak are retained.

Adding conference units to the conference system during operation

You can also add conference units to the conference system during operation (see page 17).

All added delegate units are ready for immediate use. If you add chairman units, you have to re-initialize them. Note that this will interrupt the conference (see page 30 or page 88).

If you are using the "Conference Manager" software, newly added conference units only appear in the Delegate View window. The entry in the "Delegate" column shows the position of the conference unit in the cable string (e.g. "Unkn. at 3").

Via the Delegate View window of the "Conference Manager" software, you can also control conference units that are not initialized (see page 100).

ID	Delegate	Queue
--	Unkn. at 3	<input type="checkbox"/>
--	Unkn. at 4	<input type="checkbox"/>
--	Unkn. at 5	<input type="checkbox"/>



When adding conference units to the conference system, observe the maximum number of conference units in order to ensure safe operation (see page 13).

### Adjusting settings during a running conference

In "Live" operating mode, the boxes "Volume", "Audio XLR", "Talk Time" and "Conference" are shown in the lower part of the window.

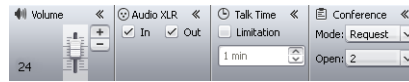

### Setting the volume of the conference units' built-in loudspeakers



#### CAUTION Danger of hearing damage due to loud hissing!



When the floor channel volume is set to a high level or when several participants speak simultaneously, feedback noise (loud hissing) can occur. This can cause hearing damage.

- ▶ Reduce the floor channel volume (see page 93 or page 101).
- ▶ Make sure that the "Audio Gain Reduction" function is activated (see page 94).  
This function reduces the gain per active microphone by the selected level and thus prevents feedback noise.
- ▶ Increase the distance between the individual conference units to at least 50 cm.

- ▶ Move the slider...  
... upwards to increase the floor channel volume or  
... downwards to reduce the floor channel volume.  
The value next to the slider changes ("0"-"32") and the floor channel volume is adjusted.

### Activating/deactivating the audio input/output

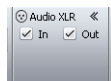

To activate or deactivate the IN audio input or the OUT audio output:

- ▶ Tick/untick the check boxes in the "Audio XLR" box:

Audio input/output	activated	deactivated
IN audio input	<input checked="" type="checkbox"/> In	<input type="checkbox"/> In
OUT audio output	<input checked="" type="checkbox"/> Out	<input type="checkbox"/> Out

### Activating/deactivating the speaking time limit

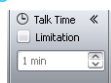

If, in "Live" operating mode, you change settings that affect the conference mode (see next chapters), the conference will be interrupted. A confirmation prompt appears:

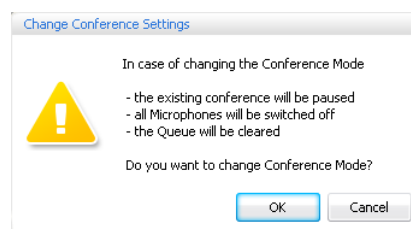

To activate or deactivate the speaking time limit:

- ▶ In the "Talk Time" box, tick/untick the "Limitation" check box (see also page 91):
  - ticked : The speaking time limit is activated.
  - unticked : The speaking time limit is deactivated.



To change the speaking time limit:

- ▶ In the "Talk Time" box, enter the desired speaking time limit into the drop-down list field (see also page 91).

Changing the conference mode

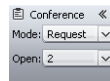

- ▶ From the "Mode" drop-down list in the "Conference" box, select the desired conference mode (see page 90).

Changing the maximum number of speakers who can take the floor simultaneously

- ▶ From the "Open" drop-down list in the "Conference" box, select the maximum number of speakers who can take the floor simultaneously (see also page 91).

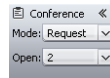

Changing the maximum number of requests to speak

- ▶ Change the maximum number of requests to speak (see page 91).

Changing the behavior of the signal light ring ② when a request to speak is made

- ▶ Change the behavior of the signal light ring ② when a request to speak is made (see page 91).

Exiting the "Live" operating mode

You can exit the "Live" operating mode by calling up the "Setup" operating mode:



- ▶ Click the "Setup" button.  
The "Stop" warning message appears.

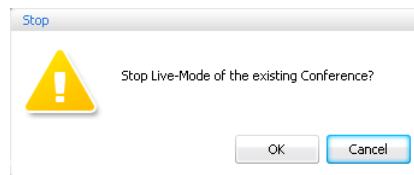

- ▶ Click "OK".  
The software switches to "Setup" operating mode and the View windows change their appearance accordingly. A running conference is **not** interrupted.

## Using the log and diagnosis function – "Event Log"

The log and diagnosis function allows you to log all changes to the conference system. As soon as a change to the system or an error is detected, the button on the toolbar changes to .

To start the "Event Log" function:

- ▶ Click the button on the toolbar.

Or, if the "Processing" window is displayed:



- ▶ Click the  button.  
The "Protocol" window appears.

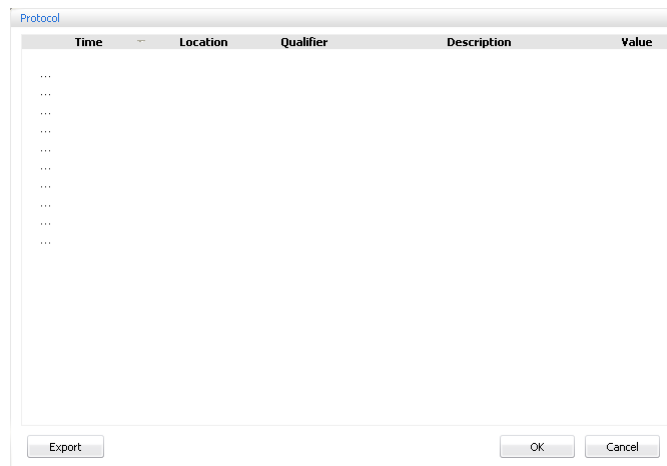

Changes and warnings are listed in chronological order:

Column	Meaning/Function
"Time"	Time
"Location"	Location of error (central unit, conference unit)
"Qualifier"	Message qualifier: <ul style="list-style-type: none"> <li>• "Info"</li> <li>• "Warning"</li> <li>• "Error"</li> <li>• "Critical Error"</li> </ul>
"Description"	Error description
"Value"	Optional additional value (e.g. error code)

#### Exporting the log\*



- ▶ Click the "Export" button.  
The "Save as ..." window appears.
- ▶ Enter a file name.
- ▶ Save the file to the desired location.
- ▶ Click "OK".  
The log is exported as a text file (\*.txt).

---

\* only if you are using the Windows version of the software



## Cleaning and maintaining the conference system

---

**CAUTION** Liquids can damage the product!

Liquids entering the product can cause a short-circuit in the electronics or damage the mechanics.  
Solvents or cleansing agents can damage the surfaces of the product.

- ▶ Keep all liquids away from the product.
  - ▶ Do not use any solvents or cleansing agents.
- 

▶ Before cleaning, switch the central unit off and disconnect it from the mains.

▶ Only use a dry and soft cloth to clean the product.

To ensure optimum cooling of the central unit:

▶ Clean the air vents on the front, back and bottom from time to time with a soft brush or paintbrush in order to avoid dust deposits.

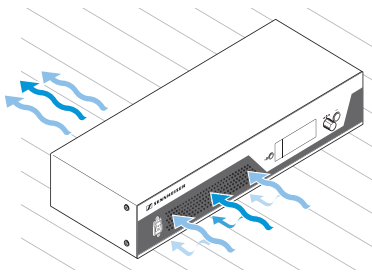

## Updating the firmware of the conference system

---

**CAUTION** Danger of damage to the conference system!

Improper modification of the firmware (e.g. due to updates) can cause irreparable damage to the conference system.

- ▶ Only update the firmware if the function of your conference system is impaired or if the update is recommended by Sennheiser.
- ▶ Contact your Sennheiser partner to update the firmware.
- ▶ While the update is in process, do **not** disconnect the central unit and the conference units from the power supply.

---

For information on firmware updates for your ADN conference system, contact your Sennheiser partner.

## If a problem occurs ...

### Conference system

Problem	Possible cause	Possible solution	Page
Central unit cannot be switched on	The central unit is not connected to the mains.	Connect the central unit to the mains.	16
Conference unit cannot be used/activated	The conference unit is not connected correctly.	Check if all plugs are connected correctly.	17
	The cable string is too long.	Reduce the length of the cable string or reduce the number of conference units.	13
	The maximum number of requests to speak has been reached.	Increase the maximum number of requests to speak.	28 or 91
	The chairman unit has not been initialized before use.	If chairman units are connected afterwards, you have to initialize them.	30 or 88
The central unit's display panel displays error icons/ the display panel lights up red	Changes or errors have occurred.	Check the possible causes indicated by the icons.	34
Volume of the conference units' loudspeakers is too high or too low	The processing of the conference units' audio signals ("Audio Gain Reduction") is adjusted so that the gain of each additional channel is reduced too much or too little.	Adjusting the processing of the conference units' audio signals.	32 or 94
	The floor channel volume is not adjusted correctly.	Adjust the floor channel volume.	48, 93 or 101
Loud hissing at the conference units' loudspeakers	The conference units are placed too close together.	Increase the distance between the individual conference units to at least 50 cm.	
	The floor channel volume is adjusted to a very high level.	Reduce the floor channel volume.	48, 93 or 101
After switch-on, the delegate units only indicate requests to speak	You are using ADN D1 delegate units exclusively. The conference mode chosen requires a chairman unit for granting speaking privileges (e.g. "Request").	Set a conference mode which does not require the grant of speaking privileges.	26 or 90
		Use an ADN C1 chairman unit to assign the "speaking right."	47
		Use the "Conference Manager" software to grant speaking privileges.	99
Delegate unit is automatically deactivated	The speaking time limit is activated.	Deactivate or increase the speaking time limit.	28 or 91
	A further speaker has made a request to speak in "Override" mode.	Change the conference mode. Increase the number of speakers who can take the floor simultaneously.	26 or 90 27 or 91
No request to speak can be made	The maximum number of requests to speak has been reached.	Increase the maximum number of requests to speak.	28 or 91
		Wait until one of the current speakers passes on his or her speaking privileges.	–
The signal light ring  does not flash when a request to speak is made	The function is deactivated.	Activate the function.	30 or 91

## "Conference Manager" software

Problem	Possible cause	Possible solution	see page
Software cannot be connected to the central unit	No network connection.	Check the connections between network, central unit and PC.	20
	The IP address of the central unit or of the Windows PC has been changed.	Check the network settings and adjust them if necessary.	50
	There is already a connection to the central unit.	Disconnect the connection to the central unit.	67
Screen connected to the central does not show anything	The screen resolution is set too high.	Reset the screen resolution.	55
Network connection between Windows PC and central unit cannot be established	No Zeroconf service installed on the Windows PC.	If the PC and the central unit are directly connected to each other, the network configuration is usually done via Zeroconf – not via DHCP. If no Zeroconf service is installed on the PC, install this service or manually assign the route (subnet: 255.255.0.0; IP address range: 169.254.0.x; x = desired IP address of the PC).	–
	Improper IP address allocation to the PC and/or the central unit.	Check the network settings and adjust them if necessary.	52
	The network communication between the central unit and the Windows PC is blocked by a proxy server and/or a firewall.		
Password forgotten	–	Delete the existing password.	64
Objects in the Room View window cannot be changed	The objects are locked.	Unlock the objects.	84
	The software runs in "Live" operating mode.	Change to "Setup" operating mode to edit the configuration.	59
Pictures cannot be imported	You are using the central unit's integrated software.	Import pictures using the Windows version of the software.	78

If a problem occurs that is not listed in the above table or if the problem cannot be solved with the proposed solutions, please contact your local Sennheiser partner for assistance.

To find a Sennheiser partner in your country, search at [www.sennheiser.com](http://www.sennheiser.com) under "Service & Support".

## Accessories

Cat. No.	Description
----------	-------------

### Central unit

502757	ADN CU1 central unit
054324	Mains cable, EU version, black, 1.8 m
054325	Mains cable, UK version, black, 1.8 m
054326	Mains cable, US version, black, 1.8 m
502031	ADN RMB-2 rack mount "ears"

### Conference units

502758	ADN D1 delegate unit
502759	ADN C1 chairman unit
504001	ADN TR 1 cable holder for conference unit

### System cables

009842	SDC CBL RJ-45-2 system cable with two shielded RJ 45 plugs, black, 2 m
009853	SDC CBL RJ-45-3 system cable with two shielded RJ 45 plugs, black, 3 m
009844	SDC CBL RJ-45-5 system cable with two shielded RJ 45 plugs, black, 5 m
009845	SDC CBL RJ-45-10 system cable with two shielded RJ 45 plugs, black, 10 m
009846	SDC CBL RJ-45-20 system cable with two shielded RJ 45 plugs, black, 20 m
009847	SDC CBL RJ-45-50 system cable with two shielded RJ 45 plugs, black, 50 m

# Specifications

## ADN D1 and ADN C1 conference units

Dimensions (w/o gooseneck)	185 x 63 x 140 mm (W x H x D)
Weight	approx. 700 g
Supply voltage	35 V ... 52.8 V ===
Power consumption	2 W (w/o reproduction via loudspeakers)
Temperature range	operation: +10°C to +40°C storage: -25°C to +70°C
Relative humidity	operation: 10 to 80% storage: 10 to 90%
Headphone socket	3.5 mm stereo jack socket
Output level at headphone socket	50 mW/16 Ω
DHT (at 1 kHz)	0.03% at 50 mW/16 Ω

### Loudspeaker

Frequency response	100 Hz to 14.5 kHz
Signal-to-noise ratio	> 70 dB(A)

### Microphone

Pick-up pattern	super-cardioid
Frequency response	190 Hz to 14.5 kHz

## ADN CU1 central unit

Dimensions	417 x 100 x 345 mm (W x H x D)
Weight	approx. 6.5 kg
Nominal input voltage	100 to 240 V~
Mains frequency	50 to 60 Hz
Power consumption	245 W
Output voltage at RJ45 EtherCAT	52.8 V ===
Nominal output current	max. 1.75 A
Temperature range	operation: +5°C to +50°C storage: -25°C to +70°C
Relative humidity	operation: 10 to 80% storage: 10 to 90%

### XLR IN

Input resistance	$R_{IN} > 10 \text{ K}\Omega$
Input level	max. +18 dBu min. -18 dBu
Nominal level	+7.5 dBu

**XLR OUT**

Output resistance	$R_{OUT} < 100 \Omega$
Frequency response	20 Hz to 14.5 kHz; -3 dB
Output level	max. +11 dBu
Nominal level	+6 dBu
DHT (at 1 kHz)	< 0.02% A-weighted at +7.5 dBu
Signal-to-noise ratio	> 80 dB A-weighted at +11 dBu

## Appendix

### ADN CU1 mounting dimensions

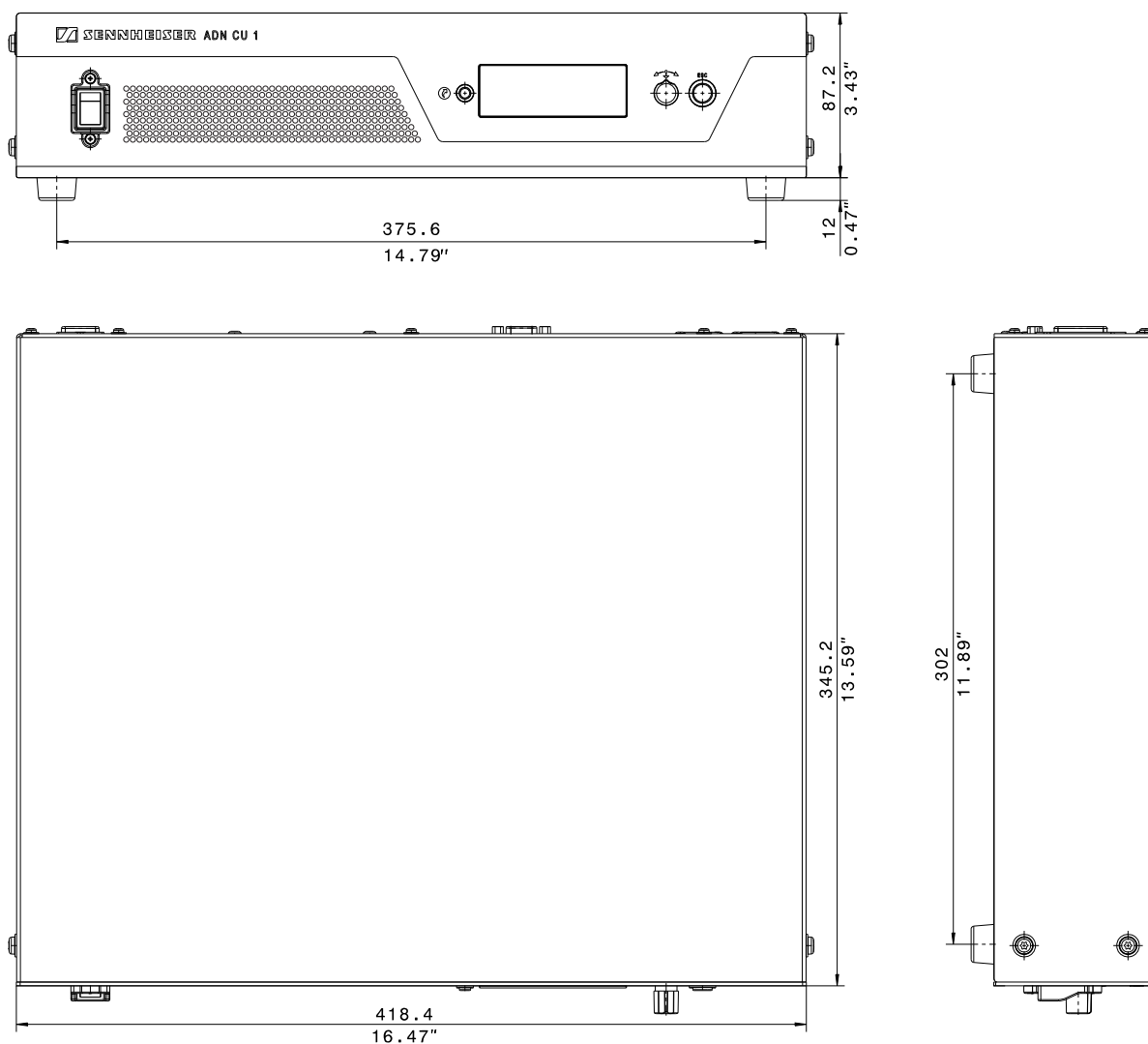

### Factory default settings

Menu item/description	Factory default settings
"Conference Mode" – conference mode	"Direct Access"
"Microphone Limit" – max. number of speakers who can take the floor simultaneously	"4"
"Request Limit" – max. number of requests to speak	"10"
"Talk Time Status" – status of speaking time limit	deactivated ("Off")
"Talk Time Limit" – length of speaking time limit	"60 Min"
"Premonition Time Limit" – advance warning time	"10 Sec"
"Reaction on Talk Time Exceed" – behavior when the individual speaking time is exceeded	microphone is deactivated immediately ("Cancel")



Menu item/description	Factory default settings
"Blink on Request" – flashing of the signal light ring when a request to speak is made	activated ("On")
"XLR Out Status" – audio output	activated ("On")
"XLR Out Volume" – audio output volume	"+ 6 dB"
"XLR OUT Equalizer" – tone color of audio output	0 dB
"XLR In Status" – audio input	activated ("On")
"XLR In Sensitivity" – input sensitivity of audio input	"+ 7.5 dBu"
"XLR IN Equalizer" – tone color of audio input	0 dB
"Floor/Loudspeakers Volume" – floor channel volume	"16"
"Floor/Loudspeakers Equalizer" – tone color of floor channel	0 dB
"Audio Gain Reduction" – processing of the volume level of the floor channel	no reduction ("0.0 dB per Mic")
"Languages" – Language of the operating menu	"English"
"IP Address Mode" – IP address allocation	"Dynamic IP"
"Contrast" – contrast of the display panel	"9"
"Lock" – lock mode function	deactivated ("Off")
Function of the priority key	requests to speak are deleted ("On")

## Keyboard layouts

The central unit support keyboards with the following language layouts:

- Arabic
- Belgian
- Brazilian
- Bulgarian
- Canadian French
- Canadian English
- Chinese
- Croatian
- Czech
- Danish
- German
- English (US)
- English (UK)
- Spanish
- Estonian
- Farsi
- Finnish
- French
- Greek
- Hebrew
- Hindi
- Hungarian
- Italian
- Japanese
- Korean
- Kannada, Kanarese
- Lithuanian
- Malay
- Dutch
- Norwegian
- Polish
- Portuguese
- Romanian
- Russian
- Slovakian
- Slovenian
- Swedish
- Swiss German
- Swiss French
- Turkic
- Ukrainian

## Microsoft Software License Terms

### Microsoft Software License Terms for Windows XP Embedded and Windows Embedded Standard Runtime

These license terms are an agreement between you and Sennheiser electronic GmbH & Co. KG (Sennheiser). Please read them. They apply to the software included on this device. The software also includes any separate media on which you received the software.

The software on this device includes software licensed from Microsoft Corporation or its affiliate.

The terms also apply to any Microsoft

- Updates,
- Supplements,
- Internet-based services, and
- Support services

for this software, unless other terms accompany those items. If so, those terms apply. If you obtain updates or supplements directly from Microsoft, then Microsoft, and not Sennheiser, licenses those to you.

**As described below, using some features also operates as your consent to the transmission of certain standard computer information for Internet-based services.**

**By using the software, you accept these terms. If you do not accept them, do not use or copy the software. Instead, contact Sennheiser to determine its return policy for a refund or credit.**

If you comply with these license terms, you have the rights below.

#### 1. Use Rights.

You may use the software on the device with which you acquired the software.

#### 2. Additional Licensing Requirements and/or Use Rights.

**a. Specific Use.** Sennheiser designed this device for a specific use. You may only use the software for that use.

**b. Other Software.** You may use other programs with the software as long as the other programs

- Directly support the manufacturer's specific use for the device, or
- Provide system utilities, resource management, or anti-virus or similar protection.

Software that provides consumer or business tasks or processes may not be run on the device. This includes email, word processing, spreadsheet, database, scheduling and personal finance software. The device may use terminal services protocols to access such software running on a server.

**c. Device Connections.**

- You may use terminal services protocols to connect the device to another device running business task or processes software such as email, word processing, scheduling or spreadsheets.
- You may allow up to ten other devices to access the software to use
- File Services,
- Print Services,
- Internet Information Services, and
- Internet Connection Sharing and Telephony Services.

The ten connection limit applies to devices that access the software indirectly through "multiplexing" or other software or hardware that pools connections. You may use unlimited inbound connections at any time via TCP/IP.

**3. Scope of License.** The software is licensed, not sold. This agreement only gives you some rights to use the software. Sennheiser and Microsoft reserve all other rights. Unless applicable law gives you more rights despite this limitation, you may use the software only as expressly permitted in this agreement. In doing so, you must comply with any technical limitations in the software that allow you to use it only in certain ways. For more information, see the software documentation or contact Sennheiser. Except and only to the extent permitted by applicable law despite these limitations, you may not:

- Work around any technical limitations in the software;
- Reverse engineer, decompile or disassemble the software;
- Make more copies of the software than specified in this agreement;
- Publish the software for others to copy;
- Rent, lease or lend the software; or
- Use the software for commercial software hosting services.

Except as expressly provided in this agreement, rights to access the software on this device do not give you any right to implement Microsoft patents or other Microsoft intellectual property in software or devices that access this device.

You may use remote access technologies in the software such as Remote Desktop to access the software remotely from another device. You are responsible for obtaining any licenses required for use of these protocols to access other software.

**• Remote Boot Feature.** If the Sennheiser enabled the device Remote Boot feature of the software, you may

- (i) use the Remote Boot Installation Service (RBIS) tool only to install one copy of the software on your server and to deploy the software on licensed devices as part of the Remote Boot process; and
- (ii) use the Remote Boot Installation Service only for deployment of the software to devices as part of the Remote Boot process; and
- (iii) download the software to licensed devices and use it on them.

For more information, please refer to the device documentation or contact Sennheiser.

**• Internet-Based Services.** Microsoft provides Internet-based services with the software. Microsoft may change or cancel them at any time.

- a. **Consent for Internet-Based Services.** The software features described below connect to Microsoft or service provider computer systems over the Internet. In some cases, you will not receive a separate notice when they connect. You may switch off these features or not use them. For more information about these features, visit <http://www.microsoft.com/windowsxp/downloads/updates/sp2/docs/privacy.msp>.  
By using these features, you consent to the transmission of this information. Microsoft does not use the information to identify or contact you.
- b. **Computer Information.** The following features use Internet protocols, which send to the appropriate systems computer information, such as your Internet protocol address, the type of operating system, browser and name and version of the software you are using, and the language code of the device where you installed the software. Microsoft uses this information to make the Internet-based services available to you.
- **Web Content Features.** Features in the software can retrieve related content from Microsoft and provide it to you. To provide the content, these features send to Microsoft the type of operating system, name and version of the software you are using, type of browser and language code of the device where the software was installed. Examples of these features are clip art, templates, online training, online assistance and Appshelp. These features only operate when you activate them. You may choose to switch them off or not use them.
  - **Digital Certificates.** The software uses digital certificates. These digital certificates confirm the identity of Internet users sending X.509 standard encrypted information. The software retrieves certificates and updates certificate revocation lists. These security features operate only when you use the Internet.
  - **Auto Root Update.** The Auto Root Update feature updates the list of trusted certificate authorities. You can switch off the Auto Root Update feature.
  - **Windows Media Player.** When you use Windows Media Player, it checks with Microsoft for
    - Compatible online music services in your region;
    - New versions of the player; and
    - Codecs if your device does not have the correct ones for playing content. You can switch off this feature. For more information, go to: <http://microsoft.com/windows/windowsmedia/mp10/privacy.aspx>.
  - **Windows Media Digital Rights Management.** Content owners use Windows Media digital rights management technology (WMDRM) to protect their intellectual property, including copyrights. This software and third party software use WMDRM to play and copy WMDRM-protected content. If the software fails to protect the content, content owners may ask Microsoft to revoke the software's ability to use WMDRM to play or copy protected content. Revocation does not affect other content. When you download licenses for protected content, you agree that Microsoft may include a revocation list with the licenses. Content owners may require you to upgrade WMDRM to access their content. Microsoft software that includes WMDRM will ask for your consent prior to the upgrade. If you decline an upgrade, you will not be able to access content that requires the upgrade. You may switch off WMDRM features that access the Internet. When these features are off, you can still play content for which you have a valid license.
- c. **Misuse of Internet-based Services.** You may not use these services in any way that could harm them or impair anyone else's use of them. You may not use the services to try to gain unauthorized access to any service, data, account or network by any means.
4. **Windows Update Agent (also known as Software Update Services).** The software on the device includes Windows Update Agent ("WUA") functionality that may enable your device to connect to and access updates ("Windows Updates") from a server installed with the required server component. Without limiting any other disclaimer in this Microsoft Software License Terms or any EULA accompanying a Windows Update, you acknowledge and agree that no warranty is provided by MS, Microsoft Corporation or their affiliates with respect to any Windows Update that you install or attempt to install on your device.
  5. **Product Support.** Contact Sennheiser for support options. Refer to the support number provided with the device.
  6. **Backup Copy.** You may make one backup copy of the software. You may use it only to reinstall the software on the device.
  7. **Proof Of License.** If you acquired the software on the device, or on a disc or other media, a genuine Certificate of Authenticity label with a genuine copy of the software identifies licensed software. To be valid, this label must be affixed to the device, or included on or in Sennheiser's software packaging. If you receive the label separately, it is not valid. You should keep the label on the device or packaging to prove that you are licensed to use the software. To identify genuine Microsoft software, see <http://www.howtotell.com>.
  8. **Transfer to a Third Party.** You may transfer the software only with the device, the Certificate of Authenticity label, and these license terms directly to a third party. Before the transfer, that party must agree that these license terms apply to the transfer and use of the software. You may not retain any copies of the software including the backup copy.
  9. **Not Fault Tolerant.** The software is not fault tolerant. Sennheiser installed the software on the device and is responsible for how it operates on the device.
  10. **Restricted Use.** The Microsoft software was designed for systems that do not require fail-safe performance. You may not use the Microsoft software in any device or system in which a malfunction of the software would result in foreseeable risk of injury or death to any person. This includes operation of nuclear facilities, aircraft navigation or communication systems and air traffic control.
  11. **No Warranties for the Software.** The software is provided "as is". You bear all risks of using it. Microsoft gives no express warranties, guarantees or conditions. Any warranties you receive regarding the device or the software do not originate from, and are not binding on, Microsoft or its affiliates. When allowed by your local laws, Sennheiser and Microsoft exclude implied warranties of merchantability, fitness for a particular purpose and non-infringement.
  12. **Liability Limitations.** You can recover from Microsoft and its affiliates only direct damages up to two hundred fifty U.S. Dollars (U.S. \$250.00). You cannot recover any other damages, including consequential, lost profits, special, indirect or incidental damages.

This limitation applies to:

- Anything related to the software, services, content (including code) on third party internet sites, or third party programs; and
- Claims for breach of contract, breach of warranty, guarantee or condition, strict liability, negligence, or other tort to the extent permitted by applicable law.

It also applies even if Microsoft should have been aware of the possibility of the damages. The above limitation may not apply to you because your country may not allow the exclusion or limitation of incidental, consequential or other damages.

13. **Export Restrictions.** The software is subject to United States export laws and regulations. You must comply with all domestic and international export laws and regulations that apply to the software. These laws include restrictions on destinations, end users and end use. For additional information, see [www.microsoft.com/exporting](http://www.microsoft.com/exporting).

# Manufacturer Declarations

## Warranty

Sennheiser electronic GmbH & Co. KG gives a warranty of 24 months on this product.

For the current warranty conditions, please visit our website at [www.sennheiser.com](http://www.sennheiser.com) or contact your Sennheiser partner.

## In compliance with the following requirements

- RoHS Directive (2002/95/EC)
- WEEE Directive (2002/96/EC)



Please dispose of the product at the end of its operational lifetime by taking it to your local collection point or recycling center for such equipment.

## CE Declaration of Conformity

- **CE**
- EMC Directive (2004/108/EC)
- Low Voltage Directive (2006/95/EC)

The declaration is available at [www.sennheiser.com](http://www.sennheiser.com).

## Trademarks

Sennheiser is a registered trademark of Sennheiser electronic GmbH & Co. KG.

Other product and company names mentioned in this instruction manual may be the trademarks or registered trademarks of their respective holders.

# Index

## A

- Accessories 108
- Adding
  - conference units 48
- ADN C1, *see* chairman unit
- ADN CU1 display panel, *see* display panel
- ADN CU1, *see* central unit
- Advance warning time
  - adjusting 28, 91
- Audio devices
  - connecting to the central unit 19
- Audio Gain Reduction 32, 94
- Audio IN and Audio OUT 19, 31
  - adjusting audio settings 93, 95
- Audio settings
  - adjusting 31, 93, 95

## B

- Behavior when the speaking time limit is exceeded
  - adjusting 29, 92
- Blink on Request 30
- Break Counter 39
  - resetting 40
- Bus Statistics 39

## C

- Cable fault 34
- Cable holders
  - installing 17
- Cancel function 47
- Central unit
  - adjusting further settings 42
  - Audio IN and Audio OUT 19
  - configuring the screen, mouse, and keyboard settings 63
  - connecting external audio devices 19
  - connecting to a PC 20
  - connecting to the Conference Manager software 49
  - connecting to the mains 16
  - functions of the keys 21
  - language 41
  - mounting into a 19" rack 15
  - network settings 42
  - operating menu 22
  - overview 10
  - setting up 15
  - switching on/off 20
  - using 21
- Chairman unit
  - activating the microphone 45
  - configuring the priority key 30
  - connecting to the central unit 17
  - deactivating the microphone 45, 99
  - ending a conference 47
  - granting speaking privileges 47
  - initializing 30, 86
    - muting all delegate units 48
    - operating 46
    - overview 9
    - preparing for use 16
- Cleaning 104
- Clear Request List on Cancel 30
- Conference Manager 49
  - adjusting network settings 65
  - adjusting settings during a running conference 101
  - adjusting the conference mode 90
  - adjusting the language 64
  - adjusting the View windows 62
  - assigning delegates to the conference units 88
  - automatically loading a configuration 69
  - bar graphs 99
  - buttons for selecting the operating mode 58
  - changing the numbering 88
  - changing the size of the canvas 83
  - closing a configuration 70
  - conference unit icons 86, 98
  - configuring a conference 90
  - configuring the screen, mouse, and keyboard settings 63
  - Connect to CU 66
  - connecting the central unit to a PC 20
  - connecting to the central unit 66
  - controlling a conference 95
  - controlling a running conference 97
  - controlling conferences 49, 99
  - creating a configuration 67
  - creating a delegate list 85
  - creating a new file/configuration 67
  - creating graphical representations 73, 74
  - delegate list 74
  - Delegate View window 96
  - deleting a configuration 71
  - devices required for use with the central unit 19
  - eliminating connection problems 67
  - enlarging the canvas 82
  - establishing a connection between software and conference system 49
  - full screen mode 63
  - getting to know and adjusting basic features 56
  - hardware platform 49
  - initializing conference units 86
  - installing 51
  - "Live" operating mode 49, 95
  - loading a configuration/file 68
  - locking objects 84
  - log and diagnosis function 102
  - mapping a room 72, 74
  - monitoring a conference 95, 97
  - Open Active Conference Document 68
  - overview 56
  - preparing a conference 72, 90
  - preparing for use 19
  - Room View window 96
  - running on a separate Windows PC 20, 49, 50
  - running on the central unit 19, 49, 50

- saving a configuration 69
  - Scan 86
  - “Setup” operating mode 49, 72, 90
  - setting the function of the “All Micros OFF” button 92
  - starting/exiting the central unit’s integrated software 55
  - starting/exiting the Windows version of the software 55
  - using 49
  - using pictures 72, 78
  - using the software for controlling a running conference 97
  - Windows network settings 52
  - Conference mode
    - adjusting 26, 90
  - Conference settings
    - adjusting 26, 90
  - Conference system
    - checking and detecting errors 34
    - cleaning and maintaining 104
    - configuring 26, 90
    - configuring via the central unit 22
    - error icons 34
    - performing a self-test 40
    - putting into operation 15
    - setting up 17
    - structuring and controlling 13
    - switching on/off 20
    - updating the firmware 105
  - Conference units
    - adding to a running conference 48
    - cable holders 17
    - connecting to the central unit 17
    - deactivating the microphone 45, 99
    - initializing 30, 86
    - operating 45
    - overview 8, 9
    - preparing for use 16
    - setting up 17
    - using headphones 46
  - Configuring
    - via central unit 22
    - via software 90
  - Connecting
    - Conference Manager software to the central unit 49, 66
    - conference units to the central unit 17
    - Windows PC to central unit 20
    - Windows PC to the central unit 20
  - Controlling
    - conference 99
    - conference system 14
  - Current and power supply 38
- D**
- Delegate unit
    - activating the microphone 45, 99
    - connecting to the central unit 17
    - deactivating the microphone 45
    - initializing 30, 86
    - operating 45
    - overview 8
    - preparing for use 16
  - Diagnostics 38
  - Direct Access 26
  - Display panel
    - overview 11
- E**
- Equalizer
    - Audio IN and Audio OUT 31, 95
    - floor channel 32, 93
  - Error icons 34
  - Error Indication
    - resetting 40
  - Error indication 39
  - Errors
    - current and power supply 38
    - detecting and eliminating 34, 106
    - eliminating connection problems 67
    - resetting Error Indication 40
    - resetting the counter 40
    - short-circuit 38
    - system analysis 38
    - system bus errors 39
    - temperature 39
- F**
- Factory default settings 43, 111
  - Firmware 105
  - Floor channel
    - adjusting audio settings 32, 93
    - adjusting the volume 32, 93
  - Floor/Loudspeakers 32, 93
  - Further settings 42
- H**
- Headphones
    - adjusting the volume 46
    - connecting 46
- I**
- Initializing
    - conference units 30, 86
- L**
- Language
    - adjusting 41
  - Linear Divison 32, 94
  - Lock mode
    - activating/deactivating 43, 93
    - deactivating 21, 93
- M**
- Manufacturer Declarations 116
  - Maximum number of requests to speak
    - adjusting 28, 91
  - Maximum number of speakers
    - adjusting 27, 91

- Microphone
  - activating 45
  - deactivating 45
- Microphone Limit 27, 91
- N**
- Network settings 42, 65
  - configuring Windows 52
  - dynamic IP addressing 53, 65
  - static IP addressing 54, 65
- O**
- Operating menu
  - operating principles 25
- Operating mode
  - buttons 58
  - “Live” 95
  - “Setup” 86
- Override 26
- Overview
  - operating menu of the central unit 22
- P**
- PC
  - connecting to the central unit 20
  - system requirements 50
- Planning and simulating conferences 49
- Premonition Time Limit 28, 91
- Priority function 48
- Priority key
  - setting the function of 30
- Processing of the conference units’ audio signals
  - adjusting 32, 94
- R**
- Rack mounting 15
  - fastening the rack mount “ears” 15
- Reaction on Talktime Exceed 29, 92
- Re-Init 30
- Request 26
- Request Limit 28, 91
- Request to speak
  - canceling 45
- Reset Break Indication 40
- Reset Error Indication 40
- Running the software
  - on a separate Windows PC 20, 49, 50
  - on the central unit 19, 49, 50
- S**
- SDC CBL RJ-45, *see* system cables
- Short-circuit 34
- Signal light ring
  - activating/deactivating the flashing 30
- Software
  - preparing for use 19
- Software, *see* Conference Manager
- Speaking privileges
  - granting 47, 99
  - requesting 45
- Speaking time limit
  - activating/deactivating 28, 91
  - adjusting 28, 91
- Specifications 109
- Start Self-Test 40
- Structural change 34
- Structuring
  - conference system 13
- Switching on/off
  - conference system 20
- System analysis 38
- System bus errors
  - displaying 39
- System cables 12, 108
  - connecting to the central unit 17
- System Load 38
- T**
- Talk Time Limit 28, 91
- Temperature status
  - displaying 39
- V**
- Version 105
  - displaying the hardware and software version 41
- Volume
  - adjusting 32, 94
  - floor channel 32, 93



Printed in Germany  
Publ. 02/10  
535364/A01

**Sennheiser electronic GmbH & Co. KG**  
Am Labor 1, 30900 Wedemark, Germany  
[www.sennheiser.com](http://www.sennheiser.com)

