



User Guide

ACT-717B / ACT-727B / ACT-747B ACT-717 / ACT-727 / ACT-747 WIRELESS MICROPHONE SYSTEMS



MIPRO Electronics Co., Ltd

Headquarters : 814 Pei-Kang Road, Chiayi,60096,Taiwan
Tel : +886.5.238.0809 Fax : +886.5.238.0803
www.mipro.com.tw mipro@mipro.com.tw

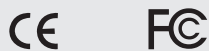

All rights reserved. Do not copy or forward without prior approvals MIPRO.
Specifications and design subject to change without notice. MN 014/02

! IMPORTANT SAFETY INSTRUCTIONS !

1. Read these instructions.
2. Keep these instructions.
3. Heed all warnings.
4. Follow all instructions.
5. Do not use this apparatus near water.
6. Clean only with a dry cloth.
7. Do not block any ventilation openings. Install in accordance with the manufacturer's instructions.
8. Do not install near any heat sources such as radiators, heat registers, stoves, or other apparatus (including amplifiers) that produce heat.
9. Do not defeat the safety purpose of the polarised or ground plug: A polarised plug has two blades with one wider than the other. The wide blade is provided for your safety. When the provided plug does not fit into your outlet, consult an electrician for replacement of the obsolete outlet.
10. Protect the power cord from being walked on or pinched particularly at plug, convenience receptacles, and the point where they exit from the apparatus.
11. Only use attachments/accessories specified by the manufacturer.
12. Use only with a cart, stand, tripod, bracket, or table specified by the manufacturer, or sold with the apparatus. When a cart is used, use caution when moving the cart/apparatus combination to avoid injury from tip-over.
13. Unplug this apparatus during lightning storms or when unused for long periods of time.
14. Refer all servicing to qualified service personnel. Servicing is required when the apparatus has been damaged in any way, such as power-supply cord or plug is damaged, liquid has been spilled or objects have fallen into the apparatus, the apparatus has been exposed to rain or moisture, does not operate normally, or has been dropped.
15. To reduce the risk of fire or electric shock, do not expose this apparatus to rain or moisture.
16. Apparatus should not be exposed to dripping or splashing and no objects filled with liquids, should be placed on the apparatus.
17. Use only with the battery which specified by manufacturer.
18. The power supply cord set is to be the main disconnected device.



WARNING

1. **FOR OUTDOOR USE:**
To reduce the risk of fire or electric shock, do not expose this apparatus to rain or moisture.
2. **UNDER WET LOCATION:**
Apparatus should not be exposed to dripping or splashing and no objects filled with liquids, such as vases should be placed on the apparatus.
3. **SERVICE INSTRUCTIONS:**
CAUTION - These servicing instructions are for use by qualified service personnel only. To reduce the risk of electric shock, do not perform any servicing other than that contained in the operating instructions unless you are qualified to do so.



 This symbol indicates that dangerous voltage constituting a risk of electric shock is present within this unit.

 This symbol indicates that there are important operating and maintenance instructions in the literature accompanying this unit.

FC & IC - ID

THIS DEVICE COMPLIES WITH PART15 OF THE FCC RULES AND RSS-123 ISSUE2 OF CANADA. OPERATION IS SUBJECT TO THE FOLLOWING TWO CONDITIONS:

- (1) This device may not cause interference.
- (2) This device must accept any interference, including interference that may cause undesired operation of the device. This equipment complies with FCC RF radiation exposure limits set forth for an uncontrolled environment.

Disposal



2008-08-13

Dispose of any unusable devices or batteries responsibly and in accordance with any applicable regulations.

Disposing of used batteries with domestic waste is to be avoided!

Batteries / NiCad cells often contain heavy metals such as cadmium(Cd), mercury(Hg) and lead(Pb) that makes them unsuitable for disposal with domestic waste. You may return spent batteries/ accumulators free of charge to recycling centres or anywhere else batteries/accumulators are sold.

By doing so, you contribute to the conservation of our environment!

TRUE DIVERSITY RECEIVERS

2 MIPRO'S Proprietary "ACT" Function & Operation
3 Part Names and Functions
6 Receiver Installation
7 Receiver Operation Tips
8 Rackmount Installation for Receivers
11 Receiver VFD Interface
22 Computer Network Interface Operation
23 General Tips for Improving System Performance
24 Troubleshooting

Included Accessories

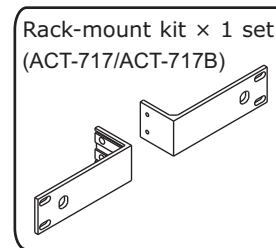
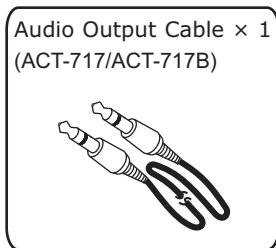
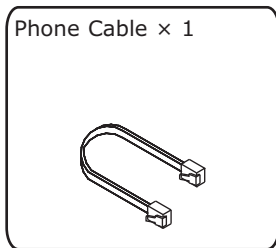
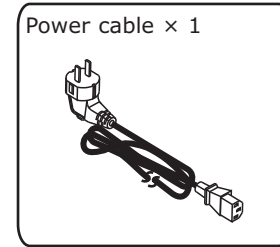
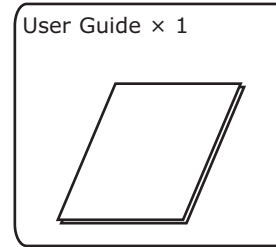
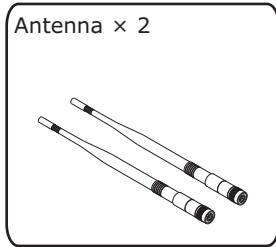

MIPRO'S PROPRIETARY "ACT" FUNCTION & OPERATION

What is ACT?

"ACT" stands for "Automatic Channel Targeting". MIPRO was the first manufacturer in the industry to use infrared (IR) technology to automatically synchronize the frequency selected on the receiver to any ACT handheld or bodypack transmitter on the same frequency band.

ACT Features

- No manual frequency adjusting needed, unlike traditional transmitters.
- Simple, fast and precise frequency set-up without mechanical errors.
- Once the frequency has been set, the data is stored in memory, meaning that the frequency is set until it is changed by performing the "ACT" function again, even after powering off.

ACT Set-Up

- Ensure a receiver channel is set up.
- Press and release the "ACT" button to activate the ACT function. Once activated, the word "ACT" appears.
- Locate the transmitter infrared (IR) port and bring it within 30cm (12") of the receiver's ACT port. The receiver's IR port is a round "window" located between the ACT & SET buttons. The transmitter IR port is normally indicated by a round red colored spot.
- When the frequencies are synchronized successfully between the transmitter and receiver, the word "ACT" disappears and the original group and channel reappears.

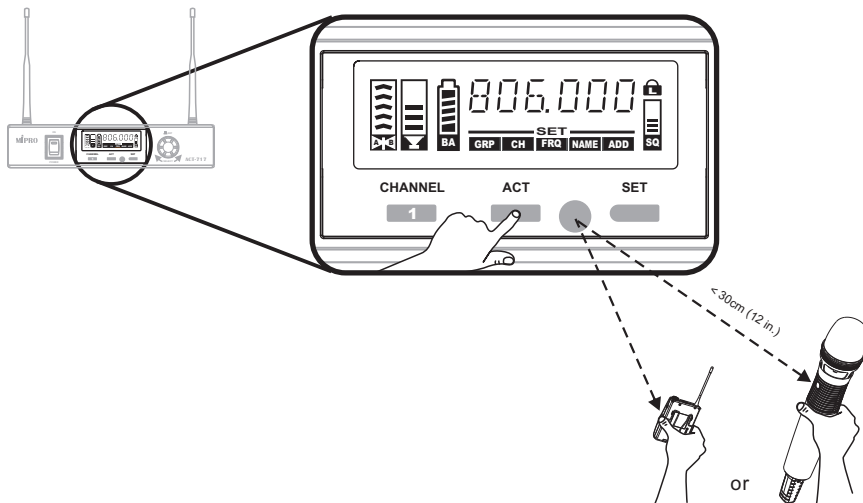

PART NAMES AND FUNCTIONS

Front Panel:

ACT-717 / ACT-717B Single-Channel True-Diversity Receiver

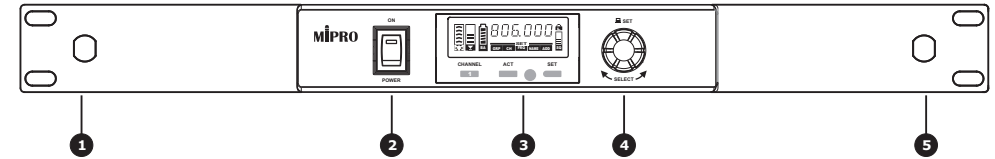

ACT-727 / ACT-727B Dual-Channel True-Diversity Receiver

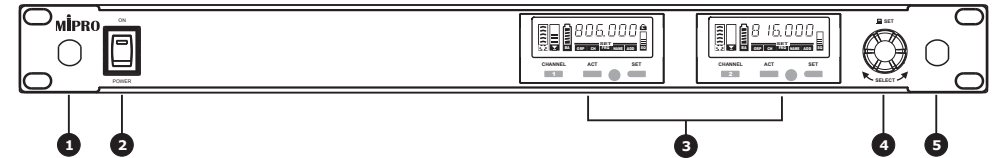

ACT-747 / ACT-747B Four-Channel True-Diversity Receiver

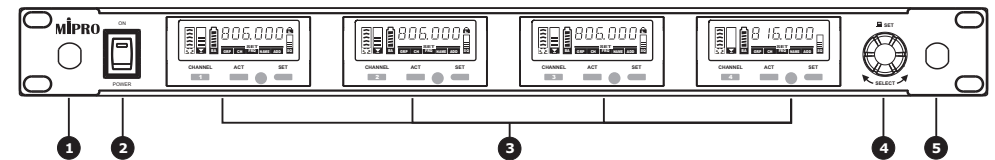

- 1 **Antenna "A" Front Mount:** Allows an optional FBC-71 rear-to-front antenna cable for front antenna placement.
- 2 **Power Switch and Indicator:** When the switch is turned on, the red indicator illuminates to denote normal power status.
- 3 **Receiver Display:** Color VFDs.
- 4 **Rotary Controller:** To set up parameters. Move cursors by turning the control clockwise or counterclockwise.
- 5 **Antenna "B" Front Mount:** Allows an optional FBC-71 rear-to-front antenna cable for front antenna placement.

Rear Panel:

ACT-717 / ACT-717B Single-Channel True-Diversity Receiver

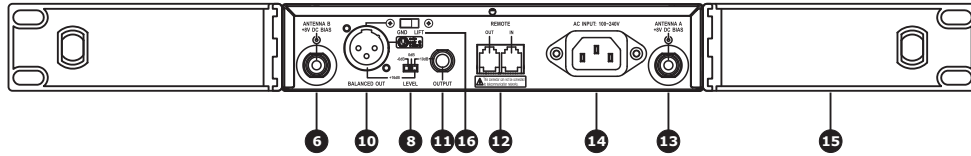

ACT-727 / ACT-727B Dual-Channel True-Diversity Receiver

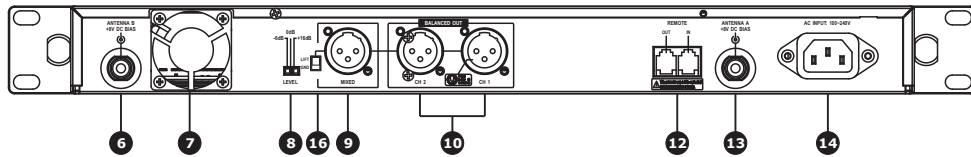

ACT-747 / ACT-747B Four-Channel True-Diversity Receiver

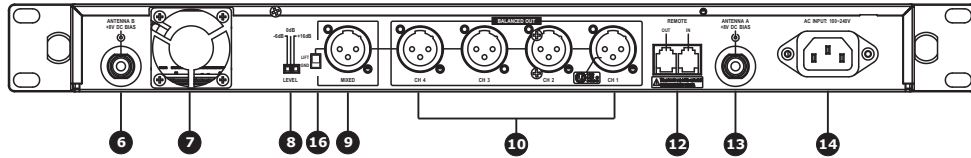

- 6 **Rear Antenna "B" Input Connector:** The "B" antenna can be installed directly to this antenna connector which also provides power to an optional antenna booster.
- 7 **Ventilation Fan:** Ensures stable performance in long hours of operation under high temperature environments.
- 8 **Level Switch:** "0dB" selection is for "Microphone level" output. "+16dB" selection is for "AUX level" output. "-6dB" selection is for half of cable microphone volume.
- 9 **Mixed AF Output Jack:** A balanced output jack for mixed AF signals from all installed channels; 3 output levels to choose from.
- 10 **Balanced Audio Output Jack:** XLR type connector provides balanced audio output signal from this jack to the mixer, and output level is selectable from among 3 levels: "-6dB", "0dB" and "+16dB".

- 11 **Unbalanced Audio Output Jack:** ¼" PHONE PLUG type connector provides unbalanced audio output signal from this jack to the mixer (ACT-717/ACT-717B only). Output level is selectable from among 3 levels: "-6dB", "0dB" and +10dB (the switch will show +16dB on the receiver, but actually puts out +10dB on the unbalanced jack).
- 12 **Network Interface Connector:** For linking the receivers to a computer system-monitoring program.
- 13 **Rear Antenna "A" Input Connector:** The A antenna can be installed directly to this antenna connector which also provides power to an optional antenna booster.
- 14 **AC Power Socket:** The input socket for AC power ranging from 100V ~ 240V AC.
- 15 **Rack-Mount Brackets:** To install the receiver into a standard EIA 19-inch rack case.
- 16 **LIFT/GND switch:** Lifts ground from Pin 1 of the XLR connector. (GND= default).

RECEIVER INSTALLATION

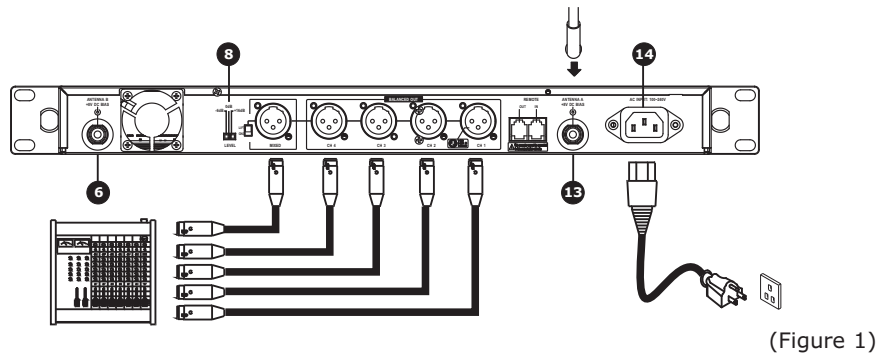

1. **Antenna Installation:** Install 2 separate antennas on the antenna sockets 6, 13 on the rear panel. Illustrated in Figure 1.
2. **AC Power Operation:** Connect the AC power cable to the AC Input Jack 14, then plug the other end into an AC outlet having the correct voltage and rating, as shown in Figure 1.
3. **Audio Output Connection:**

- **Level Switch 8 Setting Position:** When connecting from the receiver's unbalanced 1/4" output (ACT-717/ACT-717B only) to the "LINE IN" jack of a mixer or an electric guitar amplifier, switch the Level Switch 8 to the "+16dB" position. Low sensitivity may occur if switched to the wrong level position; therefore, don't use the "0dB" or "-6dB" positions as they may not deliver a sufficiently high level of input. When connecting from a receiver's balanced output to the "MIC-IN" jack of a mixer, switch the Level Switch 8 to the "0dB" position. Overload distortion may occur if switched to the wrong level position. There are many different amplifiers for Karaoke machines in today's market; however, the gain of many of these amplifier's "MIC IN" is not consistent. Therefore, if distortion is encountered, please switch the Level Switch 8 to the "-6dB" position.
- **Mixed Output:** Balanced output socket (XLR) must connect to the balanced input socket of the mixer. This output socket generates the mixed output of Ch.1~Ch.4 and the output sensitivity can be adjusted to "+16dB" or "0dB" or "-6dB" by the level switch on the right side of the socket. (ACT-727/ACT-727B & ACT-747/ACT-747B)
- **Unbalanced Output:** Using an audio output cable with 1/4" "PHONE PLUG" type connectors, connect one end from the unbalanced output jack 11 of the receiver, and the other end to the "LINE-IN" input jack of the mixer or guitar amplifier, as shown in Figure 2. (ACT-717/ACT-717B only)

- **Balanced Output:** Using audio output cables with "XLR" or "Canon" type connectors, connect one end to the balanced output jacks 10 of the receiver, and the other end to the "MIC IN" input jack of the mixer or amplifier, as shown in Figure 1. (The configuration of the 3-pin connector is as shown in Figure 3.)

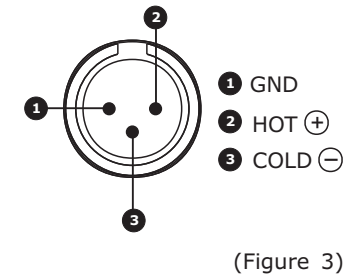
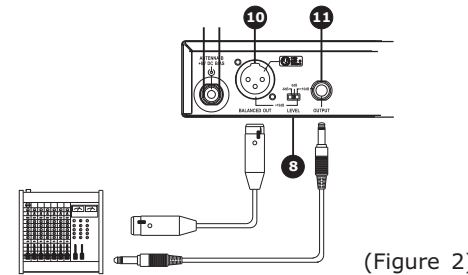

- **Electric Guitar Output:** Using audio output cable with 1/4" "phone plug" type connectors, plug one end into the unbalanced output jack of a receiver (ACT-717/ACT-717B only), and the other end into the input jack of a guitar amplifier. Switch the Level Switch 8 to "+16dB" position (the switch will show "+16dB" on the receiver, but actually puts out "+10dB" on the unbalanced jack).

RECEIVER OPERATING TIPS

- Prior to powering on the receiver, ensure all transmitters are turned off and the mixer's volume control is set to a minimized setting. Red LED power indicator is lit when powered on.
- Normally, the RF meter level glows when a transmitter is powered on to indicate the receiver is ready for operation. Once an audio signal is received from the transmitter, the AF meter level glows based on signal strength. If the meter or indicator does not glow or there is no audio output, the system may not be set up properly. Re-check that the transmitter is turned on and the receiver and transmitter are on the same frequency (if not, the transmitter will need to be reset via the ACT function).
- The microphone output level needs to be adjusted at the mixer. There is no need to adjust output levels at the receiver itself.
- The antenna inputs provide 8-volt DC biased and are designed to work with MIPRO antenna boosters. If the connecting cable is longer than 10 meters (approx. 30'), it is advisable to install an antenna booster to ensure optimal reception.
- Antenna dividers and receivers must be from the same frequency band.

RACKMOUNT INSTALLATION FOR RECEIVERS

Single half-rack receiver

- Install provided rack mount kit and fasten with screws on both sides. (Figure 4)

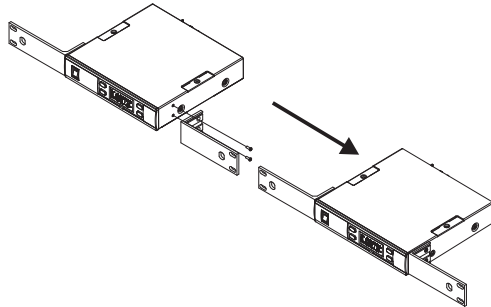

(Figure 4)

Dual half-rack receivers

- Unfasten the top and bottom screws for each receiver. Push the receivers next to each other.
- Place holding plates on top and bottom of the two receivers first, and following the directions, slide both plates into position over the screw holes. Then tighten screws (screws should be used in their original location; i.e., top screws for top holding plate and bottom screws for bottom holding plate).
- After both receivers are fixed together, fasten the rack mount kit on both sides of the joined receivers as shown in Figure 5.

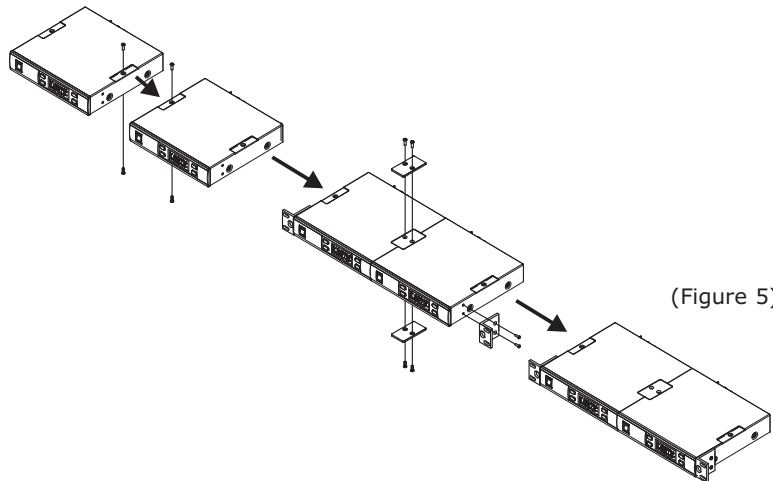

(Figure 5)

Receiver Rack-Mount Kits:

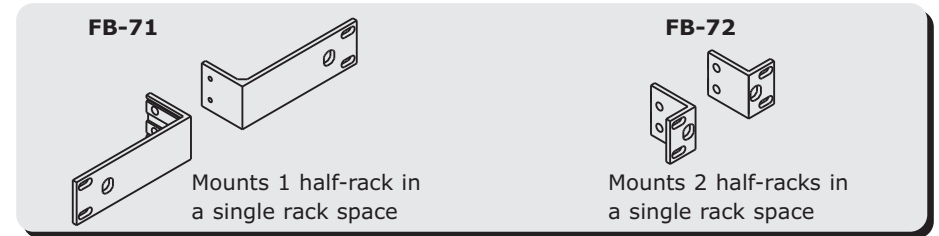

- The rack mountable kits are pre-drilled with 4 opening holes to be fitted on an EIA standard 19-inch rack case. (Figure 6)
- For ideal reception and performance, install the receiver at least 1 meter (3 feet) above the ground and away from EMI / RFI "noise" sources. In addition, place the transmitter microphone at least 1 meter (3 feet) away from the receiving antenna, as shown. (Figure 7)

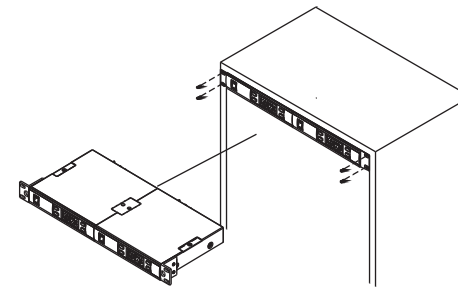

(Figure 6)

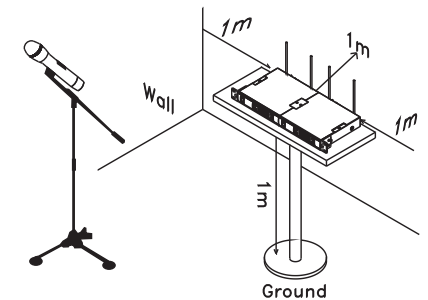

(Figure 7)

- L-Shaped steel bracket size for rack mounted function:

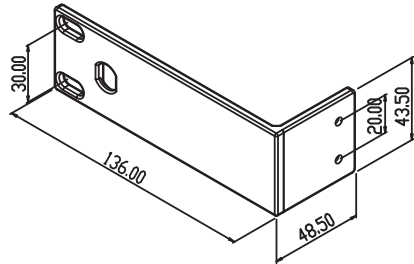

- Please note the main disconnected device is the AC Inlet
- The screw size for rack mounted function is as below:

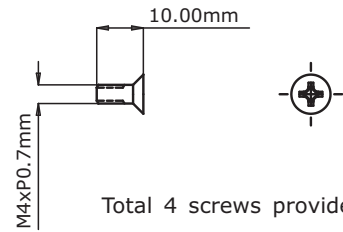

RECEIVER VFD INTERFACE

Displays all Parameters

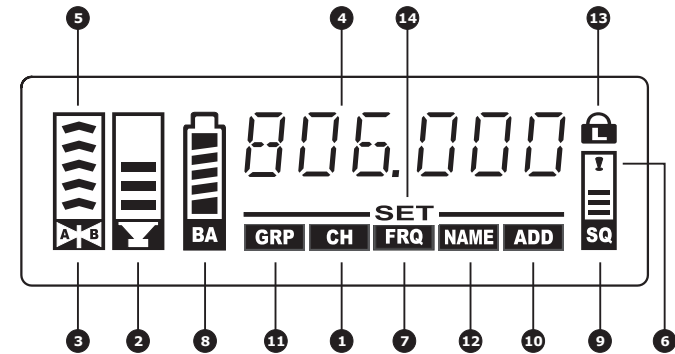

- | | |
|---|----------------------------------|
| ① Channel (can be programmed) | ② Audio Signal Meter |
| ③ Diversity A/B Antenna | ④ Working Frequency |
| ⑤ RF Signal Meter | |
| ⑥ Interference Indicator (lit denotes presence of interference) | |
| ⑦ Frequency (can be programmed) | ⑧ Battery Meter |
| ⑨ Squelch Meter (levels can be programmed) | ⑩ PC Address (can be programmed) |
| ⑪ Group (can be programmed) | ⑫ Name (can be programmed) |
| ⑬ Lock Icon (can be turned on or off) | ⑭ Setting Cursor |

Display Panel and Buttons

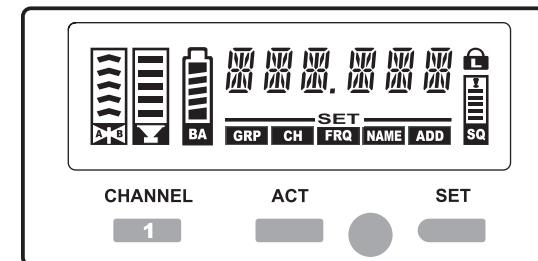

Receiver Parameters

Rotary Control Knob: To set parameter values

6 parameters can be selected and programmed. See instructions below:



Programmable Parameters:

NOTE: To confirm a parameter change and save it into the system, you must press the **SET** button to end the flashing of the **SET** cursor. If this step is missing, the new parameter is not saved and will not be stored in the system when powered off.

GRP GROUP setting

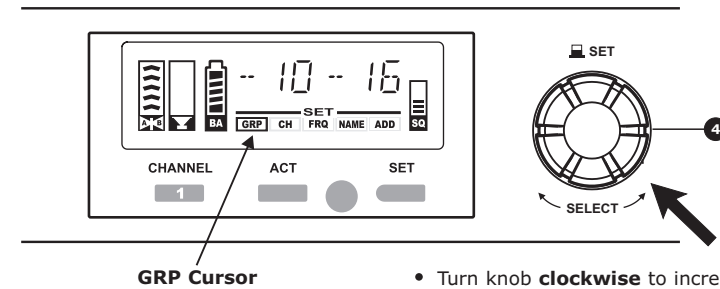

GRP Cursor

- Turn knob **clockwise** to increase values
- Turn knob **counterclockwise** to decrease values

Instructions:

1. Press and release the **SET** button once. The **SET** cursor starts flashing to denote it is ready to accept parameter changes.
2. Turn Rotary Controller **4** left or right and stop at **GRP**. Press and release the Rotary Controller **4** once and current **GRP** number starts flashing.
3. Turn Rotary Controller **4** left or right to increase or decrease **GRP** numbers.
4. Press and release the Rotary Controller **4** once to confirm the change. The **GRP** number stops flashing.
5. To confirm and save the new parameter, press and release the **SET** button once. The **SET** cursor stops flashing and the new GRP number is now stored into memory.

CH CHANNEL setting

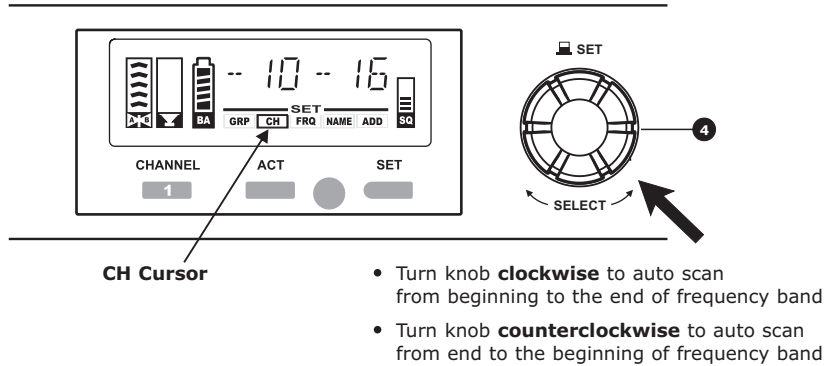

Instructions:

1. Press and release the **SET** button once. The **SET** cursor starts flashing to denote it is ready to accept parameter changes.
2. Turn Rotary Controller **4** left or right and stop at **CH**. Press and release the Rotary Controller **4** once and current **CH** number starts flashing.
3. Turn Rotary Controller **4** left or right to increase or decrease **CH** numbers. If there is interference on your chosen CH, it will automatically jump to the next interference-free CH.
4. Press and release the Rotary Controller **4** once to confirm the change. The **CH** number stops flashing.
5. To confirm and save the new parameter, press and release the **SET** button once. The **SET** cursor stops flashing and the new **CH** number is now stored into memory.

FRQ FREQUENCY setting

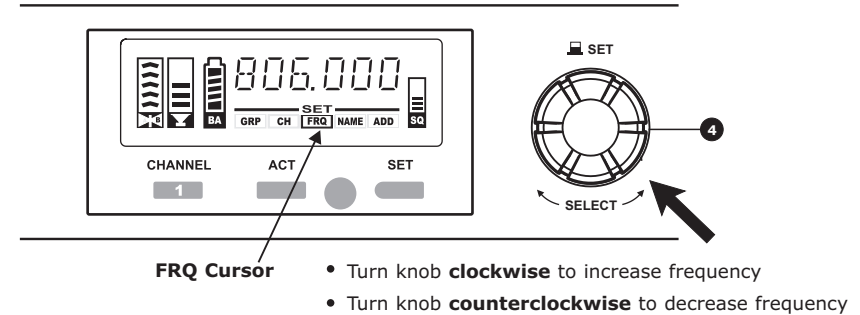

Instructions:

1. Press and release the **SET** button once. The **SET** cursor starts flashing to denote it is ready to accept parameter changes.
2. Turn Rotary Controller **4** left or right and stop at **FRQ**. Press and release the Rotary Controller **4** once and the current **FRQ** number starts flashing.
3. Turn Rotary Controller **4** left or right to increase or decrease **FRQ** numbers in increments of 1MHz (first 3 digits of the frequency #).
4. Press and release the Rotary Controller **4** again to confirm the first 3 digits, then turn left or right to adjust the last 3 digits of the **FRQ** number in increments of 25 KHz.
5. Press and release the Rotary Controller **4** once more to confirm the change. The **FRQ** number stops flashing.
6. To confirm and save the new parameter, press and release the **SET** button once. The **SET** cursor stops flashing and the new **FRQ** number is now stored into memory. If the new frequency is not one of the preset channels for that Group, the display will show asterisks in place of the Group and Channel designations.

NOTE: If a new frequency is selected that is not among the preset channels for the chosen Group, it MAY not be compatible with the other channels within that Group and may potentially cause interference. If this occurs, the frequency will need to be changed to avoid problems. The preset channels within each Group are specifically selected to work together when using multiple systems simultaneously.

NAME NAME setting

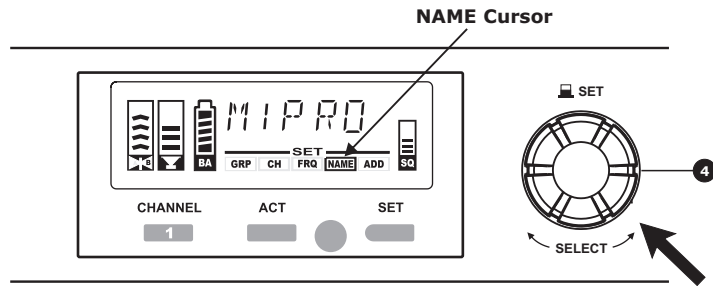

- Turn knob **clockwise** to increase letters, values, and symbols
- Turn knob **counterclockwise** to decrease letters, values, and symbols

Instructions:

1. Press and release the **SET** button once. The **SET** cursor starts flashing to denote it is ready to accept parameter changes.
2. Turn Rotary Controller **4** left or right and stop at **NAME**. Press and release the Rotary Controller **4** once and the current **NAME** alphanumeric characters start flashing.
3. Turn Rotary Controller **4** left or right for alphanumeric characters like numbers, letters and signs.
4. A total of 6 alphanumeric characters can be changed.
5. Turn and press the Rotary Controller **4** once to confirm each character change. Once all 6 characters are changed, the character stops flashing.
6. To confirm and save the new parameter, press and release the **SET** button once. The **SET** cursor stops flashing and the new NAME is now stored into memory.

ADD ADDRESS setting

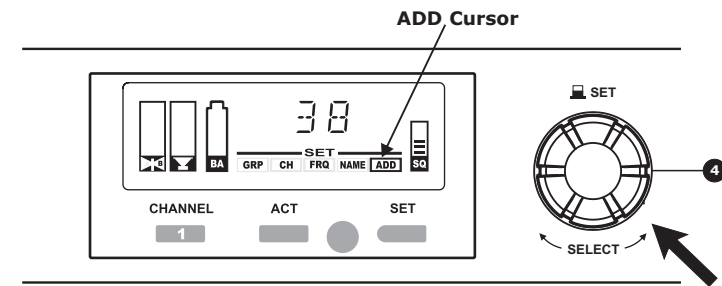

- Turn knob **clockwise** to increase values
- Turn knob **counterclockwise** to decrease values

Instructions:

1. Press and release the **SET** button once. The **SET** cursor starts flashing to denote it is ready to accept parameter changes.
2. Up to 64 receiver channels can be remotely monitored and controlled by MIPRO proprietary software and hardware via its ACT-BUS computer interface.
3. Address numbers need to be pre-programmed in advance from "01 ~ 64" before interfacing for network monitoring and control. However, to ensure networking is working properly, all address numbers need to be different from each other to avoid address conflicts. (Note: The same address number can be repeated for different receiver channels IF a computer is not being used to control / monitor the systems.)
4. Turn Rotary Controller **4** left or right and stop at **ADD**. Press and release the Rotary Controller **4** once and the current **ADD** number starts flashing.
5. Turn Rotary Controller **4** left or right to increase or decrease **ADD** numbers.
6. Press and release the Rotary Controller **4** once to confirm the change. The **ADD** number stops flashing.
7. To confirm and save the new parameter, press and release the **SET** button once. The **SET** cursor stops flashing and the new address is now stored into memory.

SQ SQUELCH setting

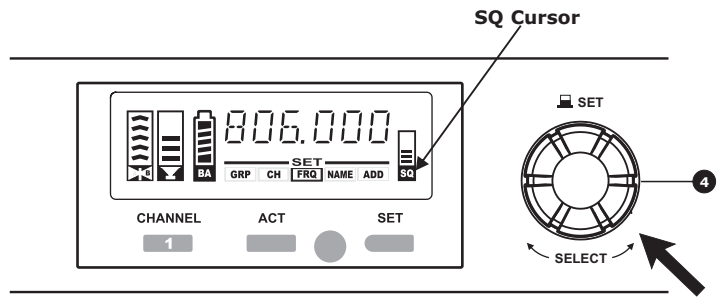

- Turn knob **clockwise** to increase one segment at a time
- Turn knob **counterclockwise** to decrease one segment at a time

Instructions:

1. Press and release the **SET** button once. The **SET** cursor starts flashing to denote it is ready to accept parameter changes.
2. Turn Rotary Controller **4** left or right and stop at **SQ**. Press and release the Rotary Controller **4** once and current **SQ** setting starts flashing.
3. Turn Rotary Controller **4** left to decrease sensitivity level by 1 indicator or turn right to increase sensitivity level by 1 indicator.
4. The higher the level indicators, the lower the sensitivity which shortens the transmission ranges. The lower the level indicators, the higher the sensitivity which increases the transmission ranges.
5. Press and release the Rotary Controller **4** once to confirm the change. The **SQ** number stops flashing.
6. To confirm and save the new parameter, press and release the **SET** button once. The **SET** cursor stops flashing and the new SQ level is now stored into memory.

Receiver Lock & Unlock

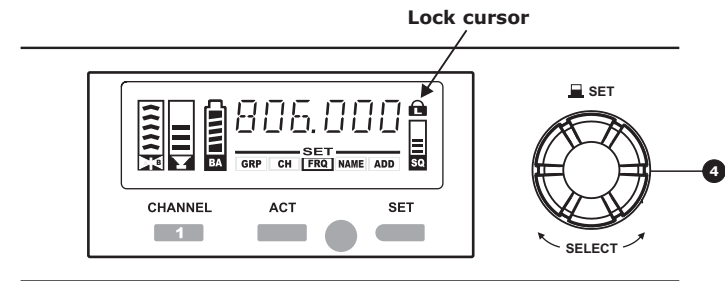

Press and hold knob to lock and unlock the display panel

Instructions:

ACT-717 / ACT-717B Receiver

1. **Receiver Lock:** Press and hold the Rotary Controller **4** until the "🔒" icon appears. Release the Rotary Controller **4** immediately when the "🔒" icon appears. When locked, the receiver parameters can no longer be changed. However, you can still navigate the Rotary Control Knob to view existing settings and parameters.
2. **Unlock Receiver:** Press and hold the Rotary Controller **4** until the "🔒" icon disappears. Release the Rotary Controller **4** immediately when the "🔒" icon disappears.

ACT-727 / ACT-727B & ACT-747 / ACT-747B Receivers

1. **To Lock or Unlock All Receiver Channels:**
Same instructions as ACT-717/ACT-717B receiver. (See "1" above)
2. **To Lock 1 Receiver Channel only:** For example, locking Channel 1. Press & hold Rotary Controller **4** until all "🔒" icons start flashing. Press & hold the **SET** button on Channel 1 when the "🔒" icon appears, then release the "Rotary Controller" and **SET** button of Channel 1 simultaneously when the rest of the "🔒" icons in the other channels disappear. Press & release the **SET** button again while the **SET** cursor is flashing to confirm and save.
3. **To Unlock 1 Receiver Channel only:**
For example, unlocking Channel 1. Press & hold Rotary Controller **4** until all "🔒" icons start flashing. Press & hold the **SET** button on Channel 1 until the "🔒" icon disappears, then release the "Rotary Controller" and **SET** button of Channel 1 simultaneously when the rest of the "🔒" icons in the other channels appear. Press & release the **SET** button again while the **SET** cursor is flashing to confirm and save.
4. **To Lock or Unlock 2~3 Channels (ACT-747 / ACT-747B):**
Follow the same procedure as above, using the **SET** button on each channel to set the lock status as desired. (Note: This is easier if you keep an eye on the unset 19 channels' icons as they flash on and off.)

Setting ACT transmitter frequency

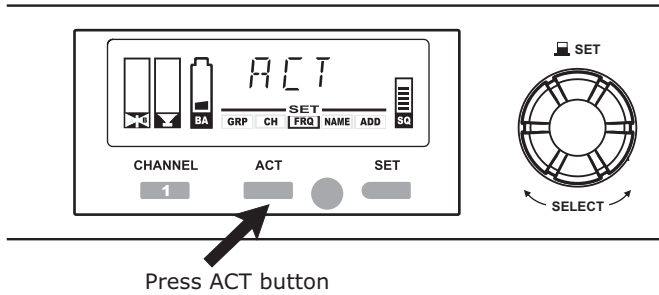

Instructions:

1. Press the **ACT** button once to activate the syncing function. The word "ACT" appears immediately on the receiver screen.
2. Bring handheld or bodypack transmitter within 30cm (12") of the IR port on the receiver. The IR port is located between the **ACT** and **SET** buttons. The frequency will sync automatically.
3. When the sync is done successfully, the word "ACT" will disappear from the receiver screen and the transmitter LCD will show the group & channel.
4. The word "A--LOSE " will appear on the receiver screen after 10 seconds if the syncing was unsuccessful. To start the " ACT " syncing again, press the **ACT** button again.

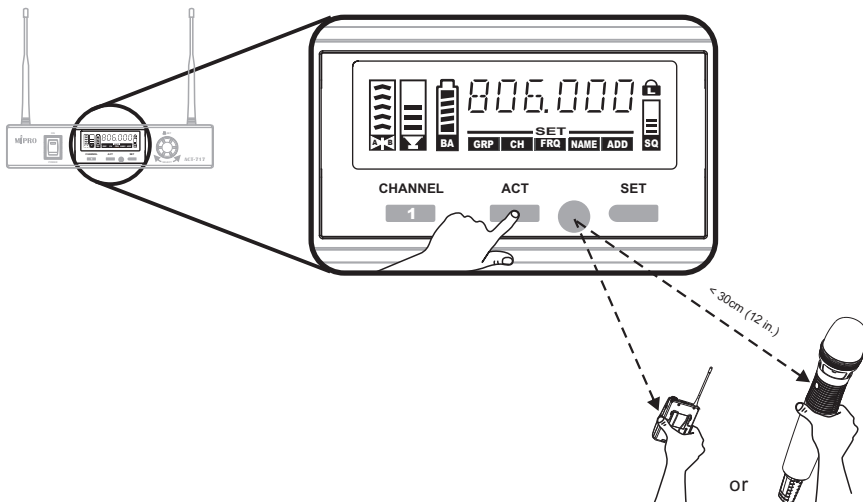

BA:Transmitter Battery Meter



The battery meter is lit when the transmitter is powered on. The LCD battery meter gives a % indication of remaining battery life, as shown above. Replace with new, fresh batteries when battery indicators fall to 10% (1 level remaining).

COMPUTER NETWORK INTERFACE OPERATION

1. MIPRO ACT receivers have an advanced computer network-interfaced controlling system.
2. Wiring Instructions
 - The network interface of ACT-717/727/747, ACT-717B/727B/747B receivers is the "REMOTE" connector 12 that can be linked to a computer by a MIPRO-DVU or MIPRO-DVJ hardware device. By using a RS-232 or USB connector, you can link to a computer through the RS-232 COM PORT or USB PORT. (See diagram below)

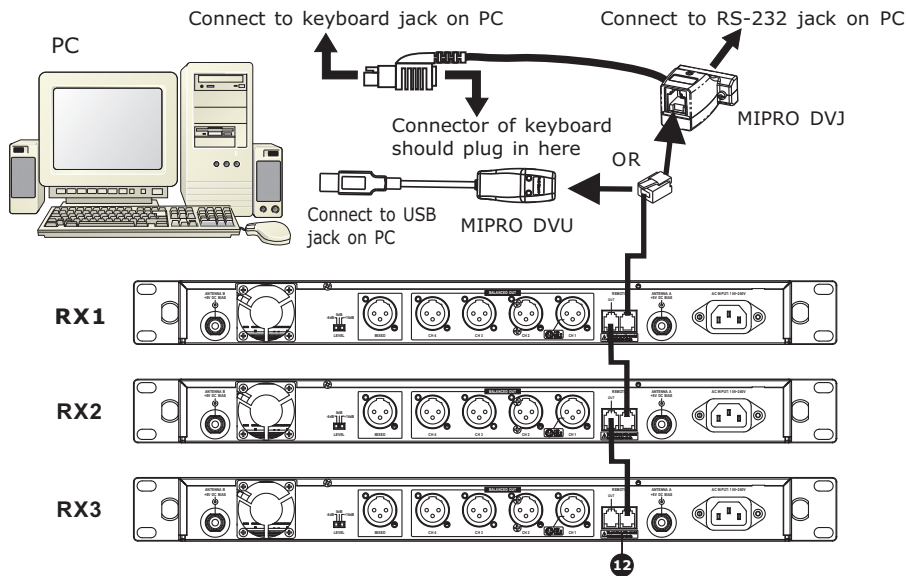

- Plug one side of the provided cable (w/ RJ-11 connectors) to the REMOTE OUT socket 12 on the rear of the receiver and the other end of the phone cable to the REMOTE IN socket 12 on the rear of the second receiver. Repeat this connection for each receiver in the system as per the illustration. Finally, connect the REMOTE IN socket 12 on the rear of the first receiver to the MIPRO-DVU or MIPRO-DVJ.
- This system can link, monitor and control up to 64 receiver channels simultaneously.
- The connecting cable to the computer can be up to 300 meters (330 yards) in length; however, signal stability decreases the longer the cable distance. Therefore, the cable length is recommended not to exceed 100m (110 yards) to maintain the highest quality as well as a high speed of transmission.

GENERAL TIPS FOR IMPROVING SYSTEM PERFORMANCE

1. Since the installation of the antenna influences the operating efficiency of the receiver, the most important rule is to minimize the distance as much as possible between the receiving antenna and the microphone for the best reception and performance.
2. Use MIPRO supplied antennas to ensure proper receiver sensitivity.
3. A built-in worldwide approved switching power supply assures stable performance in the range of 100~240V AC power input.
4. Please note the main disconnected device is the AC Inlet.
5. The antenna socket provides an 8V DC biased output. Therefore, shorting on the antenna socket should be avoided. Temporary shorting on the antenna socket will not affect system performance; however, continuous shorting on the antenna socket will cause permanent system damage.
6. If extended reception distance is needed, installing a MIPRO directional antenna kit (AT-90W) will increase the reception distance.
7. Proper antenna distribution is vital to achieving ideal performance from multiple wireless systems operating in the same environment. To greatly reduce antenna clutter in multi-system installations, a MIPRO AD-707/AD-707a UHF antenna divider system is recommended. Each AD-707/AD-707a supports up to four UHF diversity receivers to operate from a single pair of antennas. When combined with an AT-70A omnidirectional extension antenna and an AT-70B antenna booster or an AT-90W directional antenna, the AD-707/AD-707a antenna divider provides optimal signal reception with minimal dropouts or interference.
8. Preset non-interfering channels within the same channel group are recommended to ensure optimum performance from multiple wireless systems installed in the same venue. **Use of preset non-interfering channels from different channel groups may cause interference, thus is not recommended.**

TROUBLESHOOTING

Symptom	Solutions
No Sound	<ul style="list-style-type: none"> ● Power-on receiver & transmitter ● Receiver is plugged into a power outlet and cable connected to mixer/amplifier ● Fresh batteries in transmitter and inserted with correct polarity ● Match receiver & transmitter frequency
Signal Drop-outs	<ul style="list-style-type: none"> ● Close proximity between the transmitter and receiver antenna ● Line-of-sight path between the transmitter and receiver antenna ● Reposition the receiver and/or receiver antennas ● Receiver antennas are connected ● Elevate receiver antennas as high as possible ● Keep hands off of the transmitter antenna
Limited Range	<ul style="list-style-type: none"> ● Close proximity between the transmitter and receiver antenna ● Adjust antenna orientation ● Reposition the receiver and/or receiver antennas ● Receiver antennas are connected ● Undamaged antennas ● Fresh batteries in transmitter ● Adjust for proper squelch level setting
No RF Signal	<ul style="list-style-type: none"> ● Match receiver & transmitter frequency ● Adjust for proper squelch level setting
Distortion	<ul style="list-style-type: none"> ● Reduce transmitter gain, if set too high. ● Recommendation: set to 0dB (Mic Level) ● Reduce receiver output setting ● Proper setting on mixer input gain or integrated amplifier mic level control ● Fresh batteries in transmitter

TROUBLESHOOTING

Symptom	Solutions
RF Interference	<ul style="list-style-type: none"> ● Press AutoScan button to locate a clear, interference-free channel ● Use preset compatible channels in the same group when operating multiple systems. ● Place receivers away or remove the sources of RF interference like solid metal objects, electronic equipment & digital devices, dimmers, effect equipment, motors, ● Avoid operating a frequency on a local TV channel ● A higher squelch setting improves protection against interference. (however, resulting in limited range) ● Turn off one transmitter, if both transmitters are operating on the same frequency. ● Fresh batteries in transmitter
Feedback	<ul style="list-style-type: none"> ● Turn down the sound system volume ● Move microphone closer to the performer's mouth ● Reduce transmitter gain if set too high ● Position microphone further away from the speakers. Do not point towards speakers. ● Use right type of microphone for the specific applications. Uni/Omni, Supercardioid/Cardioid ● Power off all unused microphones