

# **Bose® PowerSpace+ Configuration Utility**

## **User Guide**



# Table of Contents

---

<b>Introduction</b> .....	<b>1</b>
Supported Web Browsers .....	1
Trademark Notices .....	1
Licensing .....	1
Privacy .....	1
User Interface .....	2
<b>Quick Setup</b> .....	<b>4</b>
Starting Quick Setup .....	4
Quick Setup: Signal Flow .....	5
Quick Setup: Inputs .....	6
Quick Setup: Outputs .....	7
Quick Setup: Listening Areas .....	8
Completing Quick Setup .....	9
<b>Settings Tab</b> .....	<b>10</b>
Settings: General .....	11
Settings: Network .....	12
Settings: Firmware .....	13
Settings: Import / Export .....	14
Settings: Amplifier .....	15
<b>Signal Flow Tab</b> .....	<b>16</b>
<b>Configuration Tab</b> .....	<b>17</b>
Configuration: Inputs .....	18
Configuration: Outputs .....	20
Configuration: Auxiliary Output .....	25
Configuration: Listening Areas .....	26
<b>Dashboard</b> .....	<b>30</b>
Dashboard: Status .....	31
Dashboard: Summary .....	32
<b>Appendix A: Audio and Control Connections</b> .....	<b>34</b>
Connecting Analog Audio Devices .....	34
Dynamic Microphone Connection .....	34
600 ff Telephone Paging Connection .....	35
Mute with Standard Contact Closure .....	35
Connecting to a Network .....	35
<b>Appendix B: Output and I-Share Wiring</b> .....	<b>36</b>

# Table of Contents

---

- Output Wiring .....36
- I-Share Wiring ..... 36
- Output Attenuators .....36
- Appendix C: ControlCenter Analog Zone Controller DIP Switch Configuration ..... 37**
  - CC-1 Controllers ..... 37
  - CC-2 Controllers .....38
  - CC-3 Controller .....38
  - CC-1 and CC-2 Controller Combinations .....38
- Appendix D: PowerSpace+ Amplifier Power States ..... 40**
- Licensing Information ..... 42**

## Introduction

Welcome to the Bose PowerSpace+ Configuration Utility User Guide.

This guide describes the features and functions of the integrated, browser-based PowerSpace+ Configuration Utility and the settings that you can configure to set up and modify your PowerSpace+ amplifier(s).

The PowerSpace+ Configuration Utility user interface (UI) is presented in an intuitive and logical manner that replicates the natural workflow of commercial projects. This workflow facilitates system configuration with real-time display and control of inputs, outputs, routing, and more. The simplified configuration process minimizes design errors and reduces installation time.

**IMPORTANT:** *The PowerSpace+ Configuration Utility is not password-protected. Ensure that any network connection is secure to prevent unauthorized users from changing the system configuration.*

**Note:** *An internet connection is not required for system configuration because the Web UI communicates directly with the device to retrieve and change settings, and to view real-time data.*

## Supported Web Browsers

You can access the Configuration Utility using any of the following web browsers:

- Google Chrome™ version 64.0.3282.140 or later
- Mozilla Firefox™ Quantum version 58.0.2 or later
- Microsoft Internet Explorer version 11.2007.14393.0 or later
- Microsoft Edge 38.14393.1066.0 or later

## Trademark Notices

Bose, PowerSpace, PowerSpace+ and Opti-voice are trademarks of Bose Corporation in the United States and other jurisdictions.

Google Chrome is a trademark of Google LLC.

Firefox is a trademark of the Mozilla Foundation in the U.S. and other countries.

Microsoft Internet Explorer 11 and Microsoft Edge are registered trademarks of Microsoft Corporation.

All other trademarks are the property of their respective owners.

## Licensing

Click here for [licensing information](#).

## Privacy

Click [here](#) to view the Bose Privacy Policy.

**Note:** *You must have an active internet connection to access the above link.*

## User Interface

The following illustration shows an open window in the PowerSpace+ Configuration Utility and highlights the various elements that are available, which include tabs, pages, and sections.



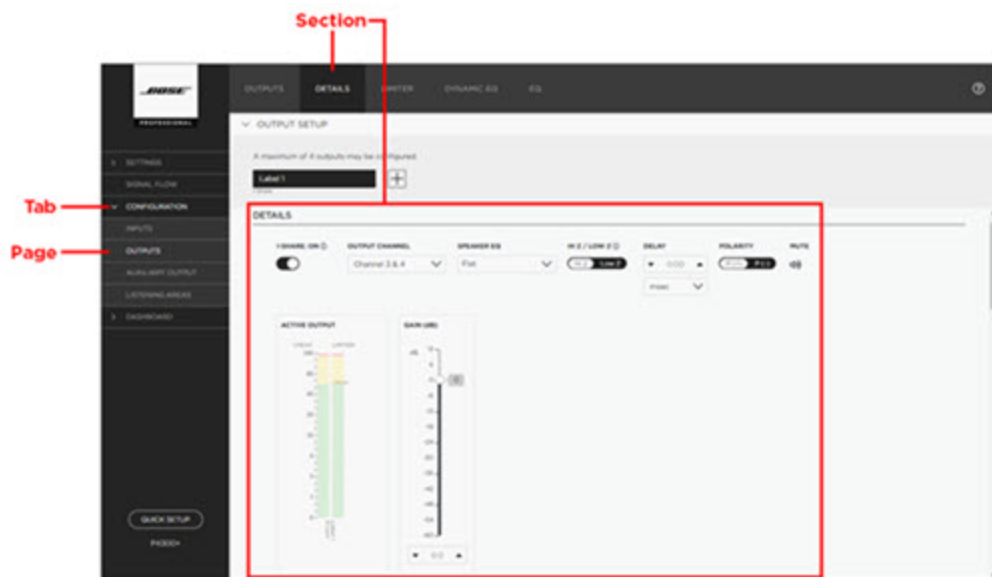



**Note:** You can click a section heading at the top of the user interface window to quickly locate that section on the page.



## User Interface Controls

The following table provides examples of the various user interface controls—and their different states, if applicable—that you may encounter when using the PowerSpace+ Configuration Utility.

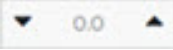
User Interface Control	Example	
Add button		
Button		
Check box	Selected:	<input checked="" type="checkbox"/>
	Not Selected:	<input type="checkbox"/>
	Unavailable:	<input type="checkbox"/>
Radio button	Selected:	<input checked="" type="radio"/>
	Not Selected:	<input type="radio"/>
	Unavailable:	<input type="radio"/>
Drop-down list		

User Interface Control	Example	
Toggle	On:	
	Off:	
	Unavailable:	
Labeled toggle	 <p><b>Note:</b> In a labeled toggle, the selection in white is the active selection.</p>	
Slider		
Up and Down arrows with Text box		
Mute icon	Mute Off:	
	Mute On:	

## Quick Setup

The PowerSpace+ Configuration Utility Quick Setup is a wizard-based tool that guides you through the initial configuration of your system.

**IMPORTANT:** All [inputs](#), [outputs](#), and [I-Share jumpers](#) (if required) must be connected, network settings must be configured, the firmware must be up to date, and any additional amplifier settings, such as [70/100 V Hi-Z output voltage](#) or enabling [Auto Standby](#) mode, must be configured before initiating the wizard. These items are located on the [Settings tab](#).

In addition, the **Network** page of the **Settings** tab allows you to configure Internet Protocol (IP) settings for the network by selecting either **DHCP** (default setting) or **Static** in the **IP Configuration** toggle.

**Note:** You are not required to use Quick Setup to configure your system. Instead, you can click **Configuration** in the left navigation panel to open the [Configuration tab](#).

**CAUTION:** Running the Quick Setup wizard will reset current system settings. Except for **Settings** tab configurations, any previously performed system configurations will be lost.

## Starting Quick Setup

The Quick Setup wizard presents system configuration tasks in a logical sequence that mimics typical workflow to facilitate system configuration.

**Note:** The amplifier automatically enters Standby mode when you start the Quick Setup wizard. When configuration is complete, you must turn on the amplifier by either pressing the front panel power button or disabling [Standby mode](#) on the [Summary](#) page of the **Dashboard** tab.

### To start the Quick Setup wizard:

1. In the bottom of the left navigation pane, click **Quick Setup**.

The **Welcome** page opens and reminds you to ensure that all inputs, outputs, and I-Share jumpers (if required) are connected and that configuration is complete on the **Settings** tab.

**Note:** If you have not already configured these settings, click the **Settings** tab link on the **Welcome** page. When you are finished configuring the settings, click **Quick Setup** again to return to the wizard.

2. In the lower-right corner of the **Welcome** page, click **Continue**.

A new page opens with a warning that: "All current configuration data will be DELETED upon pressing continue."

**Note:** **Settings** tab configurations are not deleted when you run Quick Setup.

3. Click **Yes, Continue** to proceed with configuration using the Quick Setup wizard (or click **No, Back** to return to the previous page).

The [Signal Flow](#) page opens.

**Note:** You can click the **Back** button at any time while using the wizard to return to the previous wizard page, or you can click **Exit** (at the bottom of the left navigation pane) to leave the wizard. When you click **Exit**, a dialog box appears stating, "Your progress will be lost. Are you really sure that you want to exit?" Click **OK** if you want to exit or click **Cancel** to continue using the wizard.

## Quick Setup: Signal Flow

The **Signal Flow** page provides a visual overview of your system with a block diagram that illustrates the signal flow of the system components from inputs to listening areas, and from listening areas to outputs.

This is the same diagram that appears on the [Signal Flow tab](#).

Signal flow information can help simplify troubleshooting by providing an understanding of how a signal travels from its source to its destination.

Click **Continue** to proceed to the first [Inputs](#) page of the Quick Setup Wizard.



## Quick Setup: Inputs

The Quick Setup **Inputs** pages allow you to add and configure the inputs (sources) that are installed as part of your design. You can rename each input for easy identification and inputs can be configured independently of one another.

**Note:** PowerSpace+ amplifiers allow a maximum of four inputs.

### To configure inputs using Quick Setup:

1. The first **Inputs** page lists the available input types and asks, “How many inputs, including microphones, are in your system?” Use the up and down arrows or type directly in the text box to specify the number of inputs in your system and then click **Continue**.
2. On the next page, enter a name for the input in the **Label x** text box.
3. In the **Input Channel** drop-down list, select the channel that will feed the input.
4. In the **Type** drop-down list, select the audio input type of the selected input.

**Note:** For both the P4150+ and the P4300+ amplifiers:

- Input channels 1 and 2 support balanced line-level inputs (Euroblock) or unbalanced inputs (Stereo RCA).
  - Input channel 3 supports balanced line-level inputs (Euroblock) inputs.
  - Input channel 4 supports balanced line-level inputs (Euroblock) inputs, a 600 Ohm telephone paging input, or a PTT/VOX (push-to-talk / voice-operated exchange) dynamic microphone input.
5. Select the **Stereo** check box (if available) if you wish to configure two input channels as a stereo pair.

#### Notes:

- The **Stereo** check box becomes available only after you assign a channel and an appropriate input type, and if the adjacent channel to be paired is currently unassigned.
  - Stereo can only be enabled on Euroblock input types. The **Stereo** check box is not available for RCA and paging input types.
  - When the **Stereo** check box is enabled, the **Input Channel** drop-down list contains pairs of adjacent input channels and the first available pair is automatically assigned. You can choose a different channel pair (if available) from the **Input Channel** drop-down list.
  - When stereo is enabled, “Stereo” appears under the selected input’s label.
6. Click the **Mute** icon if you wish to prevent audio from passing from the selected input to the output.
  7. Click the **Switch** toggle (if available) to specify the paging input activation mode as **PTT** (Push-to-talk) or **VOX** (voice-operated exchange).

**IMPORTANT:** The **Switch** option is only available for paging input types, which are only available on the last input channel (Channel 4).

8. Click **Continue**.

**Note:** Repeat this procedure for each input in your system. The [Outputs](#) page opens after you have finished configuring all inputs and clicked **Continue**.

---

## Quick Setup: Outputs

The **Outputs** pages in Quick Setup allow you to specify the number of outputs that are installed in your system and configure them.

**Note:** *PowerSpace+ amplifiers allow a maximum of four outputs.*

### To configure outputs using Quick Setup:

1. The first **Outputs** page asks, “How many outputs are in your system?” Use the up and down arrows or type directly in the text box to specify the number of outputs in your system, and then click **Continue**.
2. On the next **Outputs** page, enter a name for the output in the in the **Label x** text box.
3. Select the physical output channel from the **Output Channel** drop-down list.
4. Click the **I-Share** toggle (if available) if you want to enable I-Share and create an output channel pair. I-Share output delivers twice the power level (into low-impedance (2-4ff) or high-impedance (70/100V) loads) by combining the current of two output channels (channels 1 and 2, or 3 and 4). I-Share reduces the number of available outputs because it pairs output channels.

**IMPORTANT:** *You must ensure that I-Share jumpers are connected before enabling I-Share output configuration mode. To view a diagram of how to wire an output pair for I-Share mode, see [Appendix B: Output and I-Share Wiring](#).*

**Note:** *The **I-Share** toggle becomes available after the **Output Channel** is specified, and only if the channel to be paired with the specified channel is available. The allowable channel pairings are channels 1 and 2, or channels 3 and 4.*

5. Select an EQ from the **Speaker EQ** drop-down list. This setting allows you to utilize preconfigured equalization settings (presets) for Bose®loudspeakers, specify **Flat** EQ, or configure **Custom** EQ settings.
6. Click the **Polarity** toggle to set the polarity of the signal to either positive (+) or negative (-), also referred to as non-inverted and inverted, respectively.

**Note:** *Polarity is positive (+) by default.*

7. Click **Continue**.

**Note:** *Repeat this procedure for each output in your system. The [Listening Areas](#) (Routing) page opens after you have finished configuring all outputs and clicked **Continue**.*

---

## Quick Setup: Listening Areas

The **Listening Areas** pages in Quick Setup allow you to add and configure listening areas based on the distinct physical areas of your installation space.

**Note:** You can configure up to four independent listening areas.

### To configure listening areas using Quick Setup:

1. The first **Listening Areas** page provides listening area examples and asks, “How many separate listening areas are in your system?” Use the up and down arrows or type directly in the text box to specify the number of listening areas, and then click **Continue**.
2. On the next page, enter a name for the listening area in the **Area x** text box.
3. Under **Select INPUTS that will be used in this Listening Area**, specify whether you want to make any of the inputs listed in the **Inputs** column available for the listening area by selecting the check box.
4. Under **Select OUTPUTS to route audio to this Listening Area**, select the check box for any output that you want to assign to the listening area.

**Note:** You can select multiple outputs for a listening area, but once an output is assigned, it is unavailable to other listening areas.

5. In the **Type** drop-down list, select the type to specify whether the output is **Unassigned, Mono, Left,** or **Right**.

**Note:** The **Left** and **Right** options appear when the selected input is configured as Stereo.

6. Click the up and down arrows or type directly in the **Gain** text box to adjust the gain. The range of adjustment for the **Gain** setting is from -60 dB to +12 dB.
7. Click the **Mute** icon if you wish to disable audio and prevent it from passing from the selected input to the output.
8. Click **Continue**.

**Note:** Repeat this procedure for each listening area in your system. The [Quick Setup Complete](#) page opens after you have finished configuring all listening areas and clicked **Continue**.

## Completing Quick Setup

The **Quick Setup Complete** wizard page lists the advanced settings that can be found on the pages of the [Configuration tab](#).

Click **Complete** to save your settings and exit the wizard.

**IMPORTANT:** *The amplifier automatically entered Standby mode when you started the Quick Setup wizard. When configuration is complete, you must either turn on the amplifier by pressing the front panel power button or by disabling [Standby mode](#) on the [Summary](#) page of the **Dashboard** tab.*

**Note:** *The [Status](#) page of the **Dashboard** tab appears when you have exited the wizard.*

## Settings Tab

The **Settings** tab includes the following pages in which you can configure basic device and network settings, update firmware for the device, and import or export files to or from the device:

- [General](#) - Provides the amplifier model number and the ability to perform a factory reset.
- [Network](#) - IP configuration settings.
- [Firmware](#) - Version information and the ability to update the firmware.
- [Import / Export](#) - Area in which to import or export device configuration files.
- [Amplifier](#) - Options for specifying the Hi-Z constant voltage mode (70V or 100V) and mute polarity, and enabling or disabling the **Auto Standby** option and output attenuators.

## Settings: General

The **General** page allows you to view and reset device settings:

- **Model:** This setting displays the model number of the amplifier and is not configurable.
- **Factory Reset:** Click this button if you want to erase all current configurations and reset the amplifier to its factory settings.

---

## Settings: Network

The **Network** page allows you to configure Internet Protocol (IP) settings for the network by selecting either **DHCP** or **Static** in the **IP Configuration** toggle.

**Note:** *DHCP is the default network IP configuration mode. However, if your system used a DHCP router, it is strongly recommended that the PowerSpace+ device is configured with a static IP address.*

### DHCP

Dynamic Host Configuration Protocol (DHCP) dynamically assigns the IP address from a DHCP server. When you select DHCP, the IP configuration settings (**IP Address**, **Subnet Mask**, and **Gateway**) are automatically set and are not configurable.

**Note:** *No further configuration is necessary on the **Settings > Network** tab when DHCP is enabled. The following procedure is only necessary if the current IP configuration mode is **Static** and you wish to change it to **DHCP**.*

#### To change the IP configuration mode from Static to DHCP:

1. Click **DHCP** on the **IP Configuration** toggle.
2. Click **Apply**.
3. In the **Warning** dialog box, click **Continue** to save the settings and restart the device, or click **Cancel** to stop the process.

**Note:** *After changing the IP configuration mode to DHCP, you must use the Bose Discovery Tool application (which you can download from [bosepro.link/psasw](https://bosepro.link/psasw)) to reconnect to the system.*

**IMPORTANT:** *The Discovery Tool cannot identify Bose PowerSpace+ devices on Class A and Class B networks when the computer hosting the Discovery Tool has a static IP address but no defined subnet mask and gateway.*

### Link-Local IP Address (Auto IP)

If the device is set to DHCP and no DHCP server is found, such as when there is a direct connection between the device and a laptop computer, the device will automatically assign itself a link-local IP address (also known as Auto-IP) in the 169.254.1.0 to 169.254.254.255 range. You must open and run the Bose Discovery Tool application to view the device's IP address.

**Note:** *You can download the Bose Discovery Tool application from [bosepro.link/psasw](https://bosepro.link/psasw).*

### Static IP Address

Static IP address configuration allows you to manually configure a specific IP address. The **IP Address**, **Subnet Mask**, and **Gateway** options become active and must be configured when you select **Static**.

#### To change the IP configuration mode from DHCP to Static:

1. Click **Static** on the **IP Configuration** toggle.
2. In the **IP Address** text box, enter the IP address.
3. In the **Subnet Mask** text box, enter the Subnet Mask address.
4. In the **Gateway** text box, enter the default Gateway address.
5. Click **Apply**.
6. In the **Warning** dialog box, click **Continue** to save the settings and restart the device, or click **Cancel** to stop the process.

---

## Settings: Firmware

The **Firmware** page provides version information and allows you to use the Web UI to update the firmware that is installed on the device. Firmware updates can include changes to (and are not limited to) the application, amplifier firmware, the Web UI, and EQ presets.

You can view the following version information on this page:

- **Web UI Version:** displays the current version of the UI that is installed on the device.
- **Firmware Version:** displays the current version of the firmware that is installed on the device.
- **EQ Version:** displays the current version of the EQ file that is installed on the device.
- **Bootloader Version:** displays the current version of the bootloader program that is installed on the device.

## Updating Firmware

The **Firmware** section includes buttons that you can use to update the firmware that is installed on the device.

### To update the firmware:

1. Download the latest firmware version from [bosepro.link/psasw](http://bosepro.link/psasw).

**Note:** You must have an active internet connection to access the above link.

2. Click **Select File**.
3. In the **Open** dialog box, locate and select the firmware file that you downloaded in Step 1, and then click **Open**.

The name of the file you selected appears under the **Select File** button.

**Note:** If you cannot locate the firmware file in the **Open** dialog box, select **All files** from the drop-down list that appears to the right of the **File name** box.

4. Verify the selected file is correct and then click **Update**.

An **Updating Firmware** message appears in the upper-right corner of your screen. After a brief waiting period, another message appears stating that the system will restart in a few seconds.

Next, a new window opens stating, "Trying to Reconnect to Device," and after another brief waiting period, the PowerSpace+ Configuration Utility reopens.

**Note:** If you receive a *Lost Connection* error message, click **Yes** to reconnect to the system.

5. Confirm that the update was successful by verifying that the **Firmware Version** number on the **Firmware** page is correct.

**Note:** When a [link-local address](#) (also known as an auto-IP address) has been previously assigned to the device and a firmware update is performed, a new link-local address is assigned after the update is completed and the device restarts. When this occurs, the connection is lost and cannot be recovered automatically. You must use the *Discovery Tool* to rediscover the device. You must also use the *Discovery Tool* if you wish to view a device's link-local address.



---

## Settings: Import / Export

The **Import / Export** page allows you to import and export device configuration files.

### Device

The **Device** section allows you to import (upload) configuration files to the device or export (download) configuration files from the device.

#### To import a device configuration file:

1. Ensure that the file you want to import to the device is loaded onto your computer.
2. Under **Device**, click **Import**.
3. In the **Open** dialog box, locate and select the file to be imported, and then click **Open**.

**Note:** If you cannot locate the file in the **Open** dialog box, select **All files** from the drop-down list that appears to the right of the **File name** box.

The amplifier automatically enters Standby mode (if it isn't already in that state) and one of two messages appears depending upon whether I-Share is enabled in the imported configuration file.

- If I-Share is enabled in the imported configuration file, the following message appears:

*“Verify all inputs and outputs are connected to the amplifier, as well as required [I-Share jumpers](#). The amplifier is in standby mode and I-Share will be enabled when the amplifier is turned on from the front-panel power button, or by disabling standby mode in the [SUMMARY tab](#).”*

- If I-Share is not enabled in the imported configuration file, the following message appears:

*“Verify all inputs and outputs are connected to the amplifier. The amplifier is in standby mode and can be turned on from the front-panel power button, or by disabling Standby mode in the [SUMMARY tab](#).”*

4. Click **Complete**.
5. If you want to take the amplifier out of Standby mode and place it into Full Power mode, do one of the following:
  - Press the Power button on the front panel.
  - Disable the [Standby Mode](#) option in the PowerSpace+ Configuration Utility.

**Note:** If I-Share was enabled in the imported configuration file, it will remain inactive until the amplifier is turned on.

#### To export a device configuration file:

1. Under **Device**, click **Export**.
2. In the lower-left corner of the browser window, right-click the exported file and select **Show in folder** from the file menu.
3. In the computer's **Downloads** folder, locate the exported file and copy or move it to the desired location.

---

## Settings: Amplifier

The **Amplifier** page allows you to configure the following amplifier settings:

- **Hi Z:** Click either **70V** or **100V** in the toggle to specify the constant voltage mode for the Hi-Z (high impedance) output of the device.
- **Mute Polarity:** Allows you to establish the polarity for the mute contacts on the rear panel of the device. Click the toggle to select one of the following options:
  - **NO - Normally Open:** indicates that the mute contacts are normally open and a short across the mute connector will mute all outputs.
  - **NC - Normally Closed:** inverts the mute polarity where an open circuit across the mute connector will mute all outputs.
- **Auto Standby:** Click the toggle to enable or disable Auto Standby mode. When enabled, this option automatically places the amplifier into Standby mode, allowing the system to consume less power.

When the **Auto Standby** option is enabled, the amplifier is automatically placed into Standby mode when the audio signal falls below a predefined threshold (-55 dBV) for 20 minutes. The amplifier automatically exits Standby mode (wakes), within 1 second, when an audio signal above the threshold is detected.

**CAUTION:** *Enabling Auto Standby is not recommended when using VOX paging because page signals may be truncated.*

### Notes:

- You can immediately place the amplifier into Standby mode by enabling the [Standby Mode](#) option on the **Summary** page of the **Dashboard** tab.
- For more information, see [Appendix D: PowerSpace+ Amplifier Power States](#).
- **Output Attenuators:** Click the toggle to enable or disable the output attenuators on the rear panel of the amplifier. When **Disabled** is selected, the output attenuation is locked at its current level.

## Signal Flow Tab

The **Signal Flow** tab provides a visual overview of your system with a block diagram that illustrates the signal flow of your system components from inputs to listening areas, and from listening areas to outputs.

Signal flow information can help simplify troubleshooting by providing an understanding of how a signal travels from its source to its destination.

## Configuration Tab

The **Configuration** tab includes pages in which you can configure inputs, outputs, auxiliary outputs (Music on Hold and line-level output), and listening areas (routing).

**IMPORTANT:** All inputs, outputs, and [I-Share jumpers](#) (if required) must be connected, network settings must be configured, the firmware must be up to date, and any additional, optional amplifier settings, such as [70/100 V Hi-Z output voltage](#) or enabling [Auto Standby](#) mode, must be specified before configuring the system. These items are located on the [Settings tab](#).

## Configuration: Inputs

The **Inputs** page allows you to add, remove, and configure inputs (sources). Each input can be named for easy identification and inputs can be configured independently of one another.

**Note:** PowerSpace+ amplifiers allow a maximum of four inputs.

### Input Setup

The **Input Setup** area lists any existing inputs and allows you to add a new input, edit the name of an input, or delete an input.

#### To add an input:

- Under **Input Setup**, click **Add** , and then edit the input name (described below).

**Note:** The **Add** button becomes unavailable after the maximum number of inputs is reached.

#### To edit the name of an input:

- Under **Input Setup**, in the text box that contains the input name that you want to edit, click **Edit**. 

**Note:** The **Edit** icon appears when you hover over the text box.

- Type a new name for the input and then press Enter.

#### To delete an input:

- Under **Input Setup**, in the text box that contains the name of the input that you want to delete, click **Delete**. 

**Note:** The **Delete** icon appears when you hover over the text box, and only when at least two inputs exist.

- In the **Warning** dialog box, click **Yes** to remove the input, or click **No** to cancel the process.

### Details

The **Details** section of the **Inputs** page allows you to configure certain settings for the selected input. Settings vary depending upon the input type.

#### To configure details for an input:

Under **Input Setup** (at the top of the page), click the name of the input you want to configure, if it is not already selected.

**Note:** When selected, the input name box appears as white text on a black background.

You can then configure the following settings as applicable:

- Stereo:** You can configure input channels as stereo pairs by selecting the **Stereo** check box. This allows you to assign a pair of adjacent input channels by selecting the pair (channels 1 and 2, or channels 3 and 4) from the **Input Channel** drop-down list. Clear the **Stereo** check box if you want to configure the input as mono.

#### Notes:

- The **Stereo** check box becomes available only after you assign a channel and an appropriate input type, and if the adjacent channel to be paired is currently unassigned.
- Stereo can only be enabled on Euroblock input types. The **Stereo** check box is not available for RCA and paging input types.
- When the **Stereo** check box is enabled, the **Input Channel** drop-down list contains pairs of adjacent input channels and the first available pair is automatically assigned. You can choose

a different channel pair (if available) from the **Input Channel** drop-down list.

- When stereo is enabled, "Stereo" appears under the selected input's label.
- **Input Channel:** Select the physical input channel from the **Input Channel** drop-down list.
- **Type:** Select the audio input type that you want to assign to the selected input from the **Type** drop-down list. For both the P4150+ and the P4300+ amplifiers:
  - Input channels 1 and 2 support balanced line-level inputs (Euroblock) or unbalanced inputs (Stereo RCA).
  - Input channel 3 supports balanced line-level inputs (Euroblock) inputs.
  - Input channel 4 supports balanced line-level inputs (Euroblock) inputs, a 600 Ohm telephone paging input, or a PTT/VOX (push-to-talk / voice-operated exchange) dynamic microphone input.
- **Active Input meter:** Provides a current visual representation of the signal level (in dBFS) for the selected input.

**Note:** When Stereo is enabled, the **Active Input** meter displays the two channels that are paired for the selected input.
- **Gain (dB) adjuster:** Allows you to move the slider to adjust the input signal level in the -60 to +12 dB range.

**Note:** You can use the slider, the up and down arrows, or type directly in the **Gain** text box to adjust the gain.
- **Mute:** Click the **Mute** icon that appears under the **Gain** slider if you want to disable audio and prevent it from passing from the selected input to the output.
- **Tone EQ adjusters:** Allows you to move the sliders to adjust the **Low**, **Mid**, and **High** Tone EQ levels in the -15 dB to +15 dB range.

**Note:** You can use the sliders, the up and down arrows, or type directly in any of the **Tone EQ** text boxes to adjust the Tone EQ.
- **Threshold (dB) adjuster:** This setting appears only when the selected input is used for VOX paging (see the **Push To Talk / Voice Operated** option description below) and allows you to move the slider to adjust the threshold of a paging input in the -60 dB to +0 dB range.
- **Push To Talk / Voice Operated:** This option appears only if the selected input is used for paging. Click either **PTT** or **VOX** in the toggle to specify the paging input activation mode.
- **Opti-voice EQ:** This option appears only if the selected input is used for paging. Opti-voice equalizes the vocal frequency range for clear speech intelligibility and provides a smooth transition between music and announcement. Click the toggle to enable or disable Opti-voice for the selected input.

## Configuration: Outputs

The **Outputs** page includes sections in which you can add, remove, and configure outputs based on your design. Each output can be named for easy identification and outputs can be configured independently of one another.

### Notes:

- *PowerSpace+ amplifiers allow a maximum of four outputs.*
- *You can click the tabs at the top of the **Outputs** page to quickly locate a specific section.*

## Output Setup

The **Output Setup** section lists all existing outputs and allows you to add or delete an output, and edit the name of an output, if necessary.

### To add an output:

- Under **Output Setup**, click **Add** , and then edit the output name (described below).

**Note:** *The **Add** button becomes unavailable after the maximum number of outputs is reached. PowerSpace+ amplifiers allow a maximum of four outputs.*

### To edit the name of an output:

1. Under **Output Setup**, in the text box that contains the output name that you want to edit, click **Edit**. 
- Note:** *The **Edit** icon appears when you hover over the text box.*
2. Type a new name for the output and then press Enter.

### To delete an output:

1. Under **Output Setup**, in the text box that contains the name of the output that you want to delete, click **Delete**. 
- Note:** *The **Delete** icon appears when you hover over the text box, and only when at least two outputs exist.*
2. In the **Warning** dialog box, click **Yes** to remove the output, or click **No** to cancel the process.

## Details

The **Details** section allows you to configure outputs, including specifying the physical output channel and the loudspeaker EQ settings.

### To configure details for an output:

Under **Output Setup** (at the top of the page), click the name of the output you want to configure, if it is not already selected.

**Note:** *When selected, the output name box appears as white text on a black background.*

You can then configure the following settings as applicable:

- **I-Share:** Click the toggle (if available) to enable or disable I-Share output configuration mode. I-Share output delivers twice the power level (into low-impedance (2-4 ff) or high-impedance (70/100V) loads) by combining the current of two output channels (channels 1 and 2, or 3 and 4). I-Share reduces the number of available outputs because it pairs output channels.

**IMPORTANT:** *You must ensure that [I-Share jumpers](#) are connected and that the amplifier is in [Standby mode](#) before enabling I-Share output configuration mode. To view a diagram of how to wire an output pair for I-Share mode, see [Appendix B: Output and I-Share Wiring](#).*

**Note:** The **I-Share** toggle becomes available after the **Output Channel** is specified, and only if the channel to be paired with the specified channel is available. The allowable channel pairings are channels 1 and 2, or channels 3 and 4.

When you click the toggle to enable I-Share, the **Enable I-Share** dialog box appears in which you must select one of the following options:

- **Full Power** to enable I-Share and go into Full Power mode.
- **Standby** to keep the amplifier in Standby Mode where configuration can continue. I-Share will be enabled when the amplifier is turned on by the front panel power button or by disabling Standby mode on the **Summary** page of the **Dashboard** tab.

**Note:** If at any time you want to disable I-Share, when you click the toggle, the **Disable I-Share** dialog box appears to inform you that the amplifier has to enter Standby mode to complete the process. Click **Enter Standby** to proceed with disabling I-Share or click **Cancel** to keep I-Share enabled.

- **Output Channel:** Select the physical output channel for the selected output from the drop-down list.
- **Speaker EQ:** Allows you to select from among the following loudspeaker EQs for the selected output:
  - Flat EQ settings
  - Custom EQ settings
  - Bose®loudspeakers, which include preconfigured equalization settings (presets).

- **Hi Z / Low Z:** Click the toggle to select either high impedance (Hi Z) or low impedance (Low Z).

**Note:** If you select **Hi Z**, you can specify the constant voltage mode as 70V or 100V under [Amplifier Settings](#) on the **Amplifier** page of the **Settings** tab.

- **Delay:** Allows you to set the signal delay time by first specifying a number using the up and down arrows or typing directly in the text box, and then selecting the measurement type from the drop-down list. Measurement types include milliseconds (msec), meters, and feet.
- **Polarity:** Allows you to change the polarity of the signal to positive (+) or negative (-), which are also referred to as non-inverted and inverted, respectively. Polarity is positive (+) by default.
- **Mute:** Click the **Mute** icon to enable or disable muting for the output channel.
- **Active Output** meter: Displays the current output signal level as a V<sub>peak</sub> measurement with a range of 0 to 160.

**Note:** When I-Share is enabled, the Active Output meter displays two amplifier channels for the selected output.

- **Gain (dB)** adjuster: Allows you to adjust the output signal level delivered to the next gain stage. The range of adjustment is from -60 to +12 dB.

**Note:** You can use the slider, the up and down arrows, or type directly in the text box to adjust the gain.



## Limiter

The **Limiter** section enables you to specify both peak and RMS voltage limiting for loudspeaker driver protection.

**Note:** *Unless stated otherwise, the following Limiter settings are configurable only when the **Low Z** setting is selected and the **Speaker EQ** setting is **Flat** or **Custom**. When you select a Bose loudspeaker, the **Limiter** settings are specific to that loudspeaker and are visible but cannot be adjusted.*

- **Threshold (V):** Allows you to set limits on the final output-level loudspeaker protection. Click the up and down arrows or type directly in the text box(es) to specify:
  - **VPeak:** Determines the maximum signal level allowed to pass through the signal processing block. Input signal levels above the threshold will be reduced (or hard-limited) to the VPeak threshold value.
  - **VRMS:** Determines the maximum continuous RMS signal level allowed to pass unaltered through the signal processing block. Input signal levels above the threshold level will be reduced to the RMS threshold value.
- **Attack (ms):** Allows you to specify (in milliseconds) how quickly the signal is limited after it exceeds the threshold.
  - **VPeak:** This setting is not configurable.
  - **VRMS:** Click the up and down arrows or type directly in the text box to specify the amount of time an RMS signal must exceed the RMS threshold level before the gain of the signal is reduced.
- **Release (ms):** Allows you to specify (in milliseconds) the amount of time it takes to stop limiting the signal after it goes below the threshold.
  - **VPeak:** This setting is not configurable.
  - **VRMS:** Click the up and down arrows or type directly in the text box to specify the amount of time the input signal continues to be reduced after the detection signal drops below the RMS threshold setting.

## Dynamic EQ

Click the **Dynamic EQ** toggle to enable dynamic equalization for the selected loudspeaker. Dynamic EQ monitors the low-frequency output of select loudspeakers and compensates for a perceived loss of bass response at low listening levels. After enabling Dynamic EQ, you must calibrate the signal to set the threshold level.

### To calibrate the signal for Dynamic EQ:

1. Click **Calibrate**.

#### **Notes:**

- The **Calibrate** button becomes active when Dynamic EQ is enabled via the **Dynamic EQ** toggle.
- As a best practice, place yourself in the typical listening position for the output you are calibrating.

The following dialog box appears and the system will play pink noise:



2. Use an A-weighted SPL (sound pressure level) meter and click the up and down arrows or type directly in the text box to adjust the calibration level until the SPL meter reads 70 dB-SPL.
3. When you are finished, click **Complete**.

## EQ

The **EQ** section allows you to adjust up to 9-band EQ settings for selected outputs by entering the desired filter values for type, frequency, gain, Q, and bandwidth.

**Note:** EQ settings are only configurable when you select **Custom** as the **Speaker EQ** setting. If you select **Flat**, the EQ settings are not configurable. If you select a Bose loudspeaker from the **Speaker EQ** drop-down list, the EQ settings are not configurable because they are already included in Bose loudspeaker presets.

The following settings are configurable only when you select **Custom** as the **Speaker EQ** setting:

- **Graphical display:** EQ is represented graphically with the X axis representing the frequency range of 20 Hz to 20 kHz, and the Y axis representing the range of gain adjustment from -20 dB to 20 dB.

Click a numbered filter node  in the graph to enable or disable the filter. You can click on the nodes in the graph to enable or disable filters, and you can move the nodes within the graph to adjust the settings that appear in the **Filters** table (described below).

**Note:** The icon is blue when the filter is enabled.



- **Reset All:** Click **Reset All** (located above the right side of the graph) to return all EQ settings to their default values in both the graph and the **Filters** table.
- **High Pass / Low Pass** table: Allows you to enable (or disable) and configure High Pass and Low Pass EQ filters for the selected output, as follows:

- **HighPass:** Click the icon  to enable or disable the High Pass filter, which attenuates all signals below the specified frequency.

- **LowPass:** Click the icon  to enable or disable the Low Pass filter, which attenuates all signals above the specified frequency.

**Note:** The icon is blue when the filter is enabled.

- **Frequency (Hz):** Click the up and down arrows or type directly in the text box to specify the frequency in hertz where the High Pass or Low Pass filter is applied.

- **Type:** Select a Butterworth filter type from the drop-down list to adjust the slope of the attenuation curve when using High Pass or Low Pass filters. The following Butterworth filter types are available:
  - Butterworth 6 (+/-6 dB/Oct)
  - Butterworth 12 (+/-12 dB/Oct)
  - Butterworth 18 (+/-18 dB/Oct)
  - Butterworth 24 (+/-24 dB/Oct)
- **Reset:** Click **Reset** to return all settings for the filter (in that row) to their default values.
- **Filters** table: Allows you to enable or disable filters and to adjust the selected output's 9-band EQ.
  - **Filters:** Click a numbered icon  in the **Filters** column to enable or disable the filter.  
**Note:** *The icon is blue when the filter is enabled.*
  - **Type:** Select the filter type from the drop-down list. Available filter types differ according to the filter number and may include:
    - **PEQ:** Boosts and cuts the signal in the vicinity of the specified frequency.
    - **Notch:** Attenuates the signal at the specified frequency.
    - **HighShelf:** Boosts and cuts the signal above the specified frequency.
    - **LowShelf:** Boosts and cuts the signal below the specified frequency.
  - **Frequency (Hz):** Click the up and down arrows or type directly in the text box to specify the frequency in hertz where the filter is applied. The range for this setting is 20 Hz to 20 kHz.
  - **Gain (dB):** Click the up and down arrows or type directly in the text box to specify how much the filter cuts (reduces the signal at) the frequency band. The range for this setting is -20 dB to 20 dB.  
**Note:** *The **Gain** setting is not available when the selected filter type is **Notch**.*
  - **Q:** Click the up and down arrows or type directly in the text box to specify the "quality factor," which is the ratio of center frequency to bandwidth. The range for this setting is .10 to 10.  
**Note:** *The **Q** setting is linked to the **Bandwidth (Oct)** setting such that increasing **Q** decreases bandwidth, and decreasing **Q** increases bandwidth.*
  - **Bandwidth (Oct):** Click the up and down arrows or type directly in the text box to specify the octave bandwidth of the filter.  
**Note:** *The **Bandwidth (Oct)** setting is linked to the **Q** setting such that increasing bandwidth decreases **Q**, and decreasing bandwidth increases **Q**.*
  - **Reset:** Click **Reset**  to return all settings for the filter (in that row) to their default values.

## Configuration: Auxiliary Output

PowerSpace+ amplifiers include two additional, independent (auxiliary) outputs that you can configure on the **Auxiliary Output** page of the **Configuration** tab:

- **Music On Hold (MOH):** Dedicated 600 Ohm music-on-hold interface for simple integration into a phone system.
- **Line Level Output:** Line-level auxiliary output.

### Music On Hold

The dedicated 600-Ohm Music on Hold (MOH) interface provides simple integration into a PBX phone system and allows you to play music from a selected source over a phone line while a caller is on hold.

You can configure the following **Music on Hold** settings:

- **Enable Transformer (600  $\Omega$ ):** Click the toggle to enable or disable the output-balancing transformer for MOH.
- **Gain:** Click the up and down arrows or type directly in the text box to specify the gain within the -16.0 to +16.0 range (in 0.5 dB increments).
- **Input:** Select the MOH input source from the drop-down list.

### Line Level Output

The line-level auxiliary output enables you to route the signal to additional audio equipment.

You can configure the following **Line Level Output** settings:

- **Enable Aux Line Out:** Click the toggle to enable or disable the line-level auxiliary output.
- **Gain:** Click the up and down arrows or type directly in the text box to specify the gain within the -16.0 to +16.0 range (in 0.5 dB increments).
- **Input:** Select the input source that you wish to use for the auxiliary output from the drop-down list.

---

## Configuration: Listening Areas

The **Listening Areas** page allows you to add, remove, and configure listening areas (zones) based on the physical areas of your installation space. Listening areas can be named for easy identification and can be configured independently of one another.

### Notes:

- You can configure up to four independent listening areas.
- You can click the tabs at the top of the **Listening Areas** page to quickly locate a specific section.

## Listening Areas

This **Listening Areas** section lists any existing listening areas and allows you to add a new listening area, edit the name of a listening area, or delete a listening area.

### To add a listening area:

- At the top of the page under **Listening Areas**, click **Add** , and then edit the listening area name (described below).

**Note:** The **Add** button becomes unavailable after a fourth listening area is added.

### To edit the name of a listening area:

1. Under **Listening Areas**, in the box that contains the name of the listening area that you want to edit, click **Edit**. 

**Note:** The **Edit** icon appears when you hover over the text box.

2. Type a new name for the listening area and then press Enter.

### To delete a listening area:

1. Under **Listening Areas**, in the box that contains the name of the listening area that you want to delete, click **Delete**. 

**Note:** The **Delete** icon appears when you hover over the text box, and only when at least two listening areas exist.

2. In the **Warning** dialog box, click **Yes** to remove the listening area, or click **No** to cancel the process.

## Configuring a Listening Area

Under **Listening Areas**, click the name of the listening area you want to configure. When selected, the listening area name box appears as white text on a black background. You can then configure controllers, routing details, area gain, area EQ, and area paging settings, as applicable.

## Area Controller

The Bose CC-1, CC-2, and CC-3 Zone Controllers are a series of wall-mounted interfaces that are engineered to provide custom on-site volume controls.

- CC-1 provides volume control
- CC-2 provides volume control and A/B source selection
- CC-3 provides volume control and A/B/C/D source selection

Click the **Controllers** toggle if you wish to enable a controller for the selected listening area. When you enable a controller for a listening area, you must also specify:

- **Type:** Select the controller model from the drop-down list.
- **Controller:** Select the DIP switch identification number from the drop-down list. For more information, see [Appendix C: ControlCenter Analog Zone Controller DIP Switch Configuration](#).

## Routing Details

The **Routing Details** section allows you to enable and select controllers, specify sources, and select outputs for the selected listening area.

- **Select INPUTS:** The left side of the **Routing Details** section contains the settings that you can configure to select the inputs that are available to play in the selected listening area.
  - **Inputs:** This column lists the available inputs for the selected listening area. This column is not configurable.
  - **Select:** Select the check box that appears in the same row as the input that you want to use in the selected listening area. You can select multiple inputs.
  - **Switch:** The settings in this column vary depending upon whether a controller is enabled for the listening area and if so, the specified controller type.
 

Switch settings are not available (N/A) for a CC-1 controller, but if the controller type is CC-2 or CC-3, you must select a check box to assign a switch to the selected input for source selection. The available Switch settings for a CC-2 controller are A and B, and the available Switch settings for a CC-3 controller are A, B, C, and D.

**Note:** CC-2 and CC-3 controller configurations will be ignored if their Switch settings are not selected.
- **Select OUTPUTS:** The right side of the page contains the settings that allow you to select and configure the outputs within the selected listening area.
  - **Outputs:** This column lists the outputs that may be selected and configured for the selected listening area. This column is not configurable.
  - **Select:** Select the check box that appears in the same row as the output that you want to assign to the listening area. You can then specify the type, gain, and whether to mute the selected output.
  - **Type:** Specifies whether the output is **Unassigned, Mono, Left, or Right**.

**Notes:**

  - The **Left** and **Right** options appear when the selected input is configured as Stereo.
  - Outputs designated as Left and Right will play back Mono signals if a Controller adjusts the selected input to a Mono source.
  - **Gain:** Specifies the gain for the output in the selected listening area.
 

**Note:** You can use the up and down arrows or type directly in the text box to adjust the gain.
  - **Mute:** Enables or disables muting for the output in the selected listening area.

## Area Gain

The **Area Gain** section allows you to specify the following settings for the selected listening area:

- **Area Gain (dB):** Specifies the output volume level for the selected listening area.
 

**Note:** Area Gain does not adjust area paging.
- **Area Mute:** Enables or disables muting in the selected listening area.

## Area EQ

The **Area EQ** section allows you to enable or disable filters and adjust the 7-band EQ settings for the selected listening area by entering the desired filter values for type, frequency, gain, Q, and bandwidth.

- **Graphical display:** Area EQ is represented graphically with the X axis representing the frequency range of 20 Hz to 20 kHz, and the Y axis representing the range of gain adjustment from -20 dB to 20 dB. Click a filter node  in the graph to enable or disable the filter. You can click on the nodes in the graph to enable or disable filters, and you can move the nodes within the graph to adjust the settings that appear in the **Filters** table (described below).

**Note:** *The icon is blue when the filter is enabled.*

- **Reset All:** Click **Reset All** (located above the right side of the graph) to return all Area EQ settings to their default values in both the graph and the **Filters** table that appears under the graph.

The **Filters** table allows you to enable/disable and configure EQ filters for the selected listening area.

- **Filters:** Click a numbered icon  in the **Filters** column to enable or disable the filter.

**Note:** *The icon is blue when the filter is enabled.*

- **Type:** Select the filter type from the drop-down list. Available types include:

- **High Pass:** Attenuates the signal below the specified frequency. This filter type is available only on the first filter.
- **Low Pass:** Attenuates the signal above the specified frequency. This filter type is available only on the last filter.
- **PEQ:** Boosts and cuts the signal in the vicinity of the specified frequency. This filter type is available on all filters.
- **Notch:** Attenuates the signal at the specified frequency. This filter type is available only on filters 2-6.
- **HighShelf:** Boosts and cuts the signal above the specified frequency. This filter type is available only on filters 2-6.
- **LowShelf:** Boosts and cuts the signal below the specified frequency. This filter type is available only on filters 2-6.

- **Frequency (Hz):** Click the up and down arrows or type directly in the text box to specify the frequency in hertz where the filter is applied.
- **Gain (dB):** Click the up and down arrows or type directly in the text box to specify how much the filter cuts (reduces the signal at) the frequency band.

**Note:** *This setting is available only when the selected filter type is **PEQ**, **HighShelf**, or **LowShelf**.*

- **Q:** Click the up and down arrows or type directly in the text box to specify the "quality factor," which is the ratio of center frequency to bandwidth.

**Note:** *This setting is not available for the **High Pass** and **Low Pass** filter types. Q is also linked to the **Bandwidth (Oct)** setting such that increasing Q decreases bandwidth, and decreasing Q increases bandwidth.*

- **Bandwidth (Oct):** Click the up and down arrows or type directly in the text box to specify the octave bandwidth of the filter.

**Note:** *This setting is not available for the **High Pass** and **Low Pass** filter types. Bandwidth is also linked to the **Q** setting such that increasing bandwidth decreases Q, and decreasing bandwidth increases Q.*

## Area Paging

The **Area Paging** section allows you to enable (or disable) and configure paging for the selected listening area. Click the **Paging** toggle to enable or disable paging for the selected listening area. When paging is enabled, you can configure the following settings:

- **Paging Gain (dB):** Click the up and down arrows or type directly in the text box to specify the gain level of the paging signal. The range for this setting is -60 dB to 12 dB.
- **Ducking Depth (dB):** Click the up and down arrows or type directly in the text box to set the amount of attenuation to be applied to the original source signal. The range for this setting is -60 dB to 0 dB.
- **Hold Time:** Click the up and down arrows or type directly in the text box to specify the amount of time (in milliseconds) to continue attenuation after the paging source signal is discontinued. The range for this setting is 0 ms to 1000 ms.
- **Release Time:** Click the up and down arrows or type directly in the text box to specify the amount of time (in milliseconds) it will take to return to the original source signal after the Hold Time has expired. The range for this setting is 1 ms to 2000 ms.



## Dashboard

The **Dashboard** tab includes pages that provide a high-level system overview and allow you to quickly view source (input) and output activity across all configured listening areas.

### To view the Dashboard:

1. In the left pane, click **Dashboard** to expand the menu.
2. Select the **Status** or **Summary** page of the Dashboard tab, depending upon the type of information you want to view:
  - The [Status](#) page provides a visual overview of the inputs and outputs in a listening area.
  - The [Summary](#) page provides a visual overview of the entire system.

## Dashboard: Status

The **Status** page of the **Dashboard** tab provides a real-time account of the inputs and outputs for each of the listening areas that are configured in your system:

- **Listening area name:** Shows the name of the listening area.
- **Paging:** Indicates whether paging is turned on in the listening area.
- **Listening area meters:** Identify the inputs and outputs that are currently working within the selected listening area and shows their status via the following meters:
  - **Available Inputs:** Displays real-time metering for each input channel associated with a listening area.
  - **Outputs:** Displays real-time metering for each output channel associated with a listening area.

## Dashboard: Summary

The **Summary** page of the **Dashboard** tab is a visualization tool that provides a real-time account of the overall system status.

The system information provided on this page includes:

- **Live Meter:** When the device is in Full Power mode, provides a real-time temperature measurement within a color-coded range that is dependent upon the internal temperature measurement and fan speed.

Color:	Indicates:	Conditions:
Green	Safe Operating Zone	Low temperatures and low fan speed
Yellow	Thermal Warning Zone	Hotter operation and mid fan speed
Red	Thermal Fault - Amp Muted	Highest fan speed, amp outputs are muted (protection mode)

- **Standby Mode:** When enabled, this function immediately enters the amplifier into a power-saving state (Standby), allowing the system to consume less power. Click the **Standby Mode** toggle to enable Standby mode, or disable it and immediately place the amplifier into Full Power mode.

### Notes:

- When Standby mode is enabled, the meter shows the last temperature reading when the device was in Full Power mode (before Standby mode was enabled).
- You can configure the amplifier to automatically enter and exit Standby mode by enabling the [Auto Standby](#) option on the **Amplifier** page of the **Settings** tab.
- For more information, see [Appendix D: PowerSpace+ Amplifier Power States](#).
- **Inputs:** Provides a visual summary of the inputs that are configured in your system.
  - **Signal:** Replicates the Input Signal LEDs on the front of the amplifier. Each LED is associated with a single input and uses color-coded status indicators.

Color:	Indicates:
Gray	No input signal / Off
Green	Signal is present
Amber	Signal is near clipping
Red	Signal is clipping

- **Input Meters:** Provides a current visual representation of the signal level for all inputs in the system.
- **Outputs:** Provides a visual summary of all outputs that are configured in your system.
  - **Limiters:** Provide a current visual representation of the status of the Power and Loudspeaker limiters.
    - **Power:** Replicates the Output Limit LEDs on the front of the amplifier. Each LED is associated with an output and uses color-coded status indicators.

Color:	Indicates:
Gray	Off
Amber	Amplifier is limiting output (power)
Red (Solid)	Fault
Red (Blinking)	Amplifier is muted

- **Loudspeaker:** Indicates voltage limiting on output and uses color-coded status indicators.

Color:	Indicates:
Gray	Off
Amber	Amplifier is limiting output (loudspeaker)

- **Output Meters:** Provides a current visual representation of the signal level for all outputs in the system.
- **Fault Log:** Provides a record of faults that have occurred in the system. The Fault Log includes two tabs:
  - **Fault Log:** Lists only active faults to a maximum of 10. This tab includes the **Clear Active Fault Log** button, which allows you to manually move active faults from the **Fault Log** tab to the **Fault Log History** tab.
  - **Fault Log History:** Lists inactive faults and any faults that have been manually moved from the **Fault Log** tab, to a maximum of 50. This tab includes the **Download** button, which allows you to download and save a copy of the log in a .csv file.

**Note:** A fault is automatically moved from the **Fault Log** tab to the **Fault Log History** tab when the fault is cleared by the amplifier, for example, after a power cycle.

## Appendix A: Audio and Control Connections

The P4300+ and P4150+ include two types of analog inputs for audio devices: summed mono RCA connectors and balanced Euroblock connectors. A mono RCA input into input 1 (red or white) and/or input 2 (red or white) are acceptable mono audio sources.

The following diagrams show the recommended balanced/unbalanced wiring between the Euroblock audio connectors on the amplifier and common audio connectors to external audio components.

### Connecting Analog Audio Devices

Use the included green 3-pin Euroblocks to connect to the inputs, or use the orange 3-pin Euroblocks to connect to the 600 Ohm music-on-hold auxiliary output or the line-level auxiliary output.

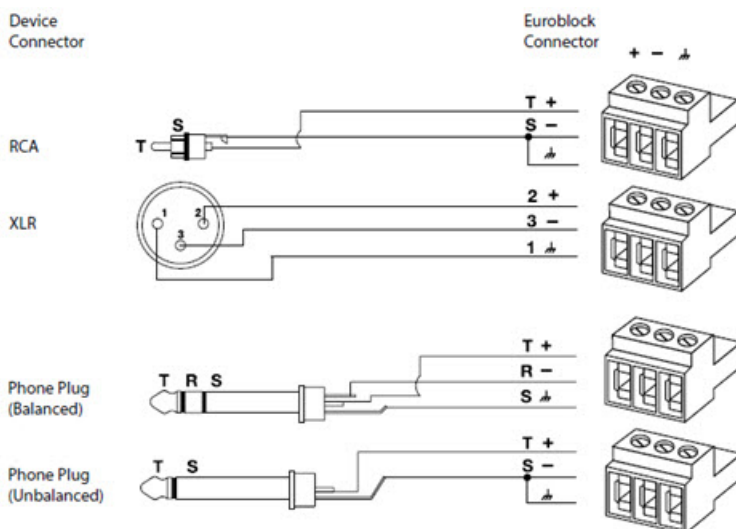

### Dynamic Microphone Connection

Input 4 of the P4300+ and P4150+ can accept either a line-level source (default), a PTT/VOX dynamic microphone, or interface to a 600 Ohm telephone paging system. You can change the input type from the default in the web-served UI. Use the included green 4-pin Euroblock to make this connection.

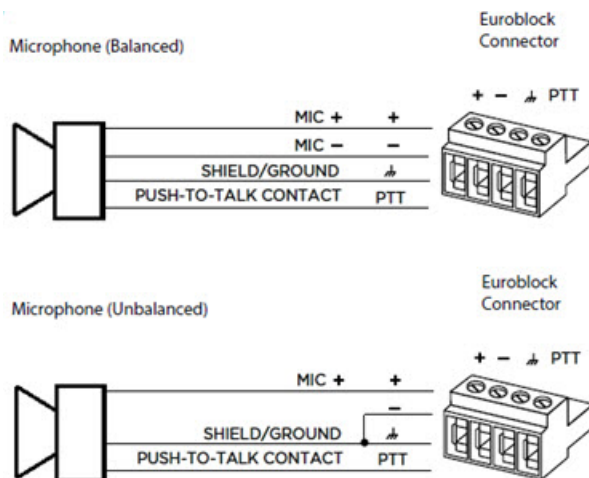

## 600 $\Omega$ Telephone Paging Connection

The default telephone paging activation method is VOX (voice activated). The telephone paging stimulus can be changed to PTT (push-to-talk) in the web-served UI. Connect the Push-to-Talk contact to the PTT pin of input 4. Use the included green 4-pin Euroblock to make this connection.

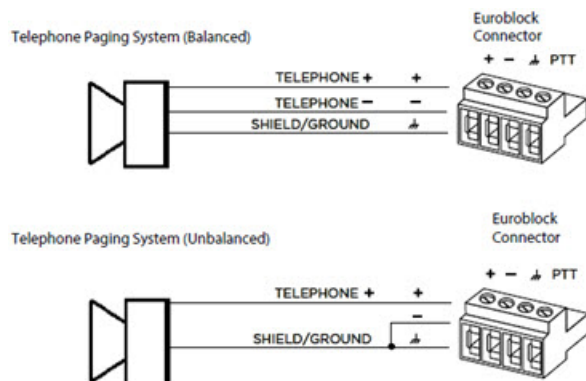

## Mute with Standard Contact Closure

The P4300+ and P4150+ are designed to mute all outputs when the Mute contacts are either shorted together or opened, depending on how the amplifier is configured.

The default state is Normally Open (NO), where a short across the mute connector will mute all outputs. Using the integrated web server, the mute polarity can be inverted to Normally Closed (NC), where an open across the mute connector will mute all outputs.

Use the included black 2-pin Euroblock to make this connection.

**Note:** All Limit LED indicators will blink red when the amplifier is muted from software or from the rear panel Mute connector.

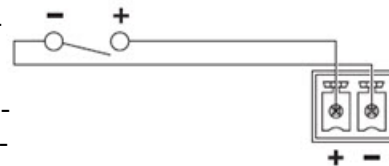

## Connecting to a Network

The P4300+ and P4150+ include an RJ-45 Ethernet port on the rear panel for network connection.

Use a foiled or unshielded twisted-pair (F/UTP) Cat 5e cable (not included) to connect this port on each amplifier to your network or computer. Make this connection directly to the amplifier or through a switched Ethernet network.



**Note:** All PowerSpace+ amplifiers are set to DHCP, which you can change by using the web-served UI.

## Appendix B: Output and I-Share Wiring

### Output Wiring

Use the included terminal forks to crimp 14-16 gauge wires for loudspeaker connections to the amplifiers' output terminal block. Ten terminal forks are included with each P4300+ and P4150+ amplifier, leaving two extra terminal forks.

Terminal fork  
(14-16 gauge)



### I-Share Wiring

I-Share outputs deliver twice the channel power level by combining the current of two channels. Each output pair of a Bose PowerSpace P4300+ or P4150+ amplifier can be I-Shared by adding the included jumper accessory and enabling I-Share in the web-served UI.

The following diagram illustrates the necessary I-Share wiring. Wire the I-Share 1 & 2 loudspeaker load to the amplifier using terminals 1+ and 1- (or 2+ and 2-). Wire the I-Share 3 & 4 loudspeaker load to the amplifier using terminals 3+ and 3- (or 4+ and 4-).

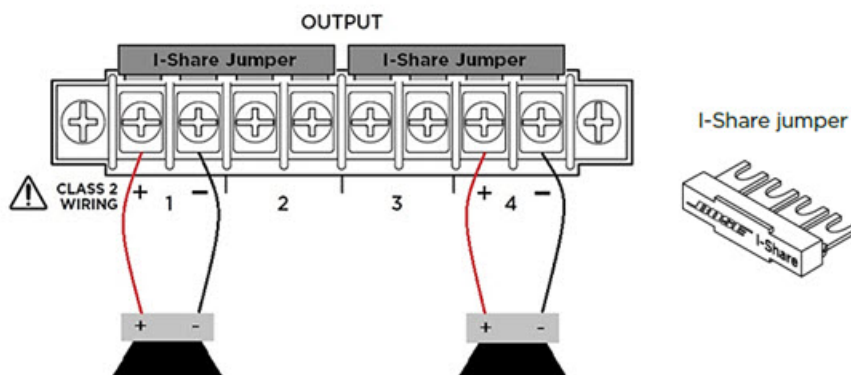

### Output Attenuators

Output attenuation controls are available for each output. Turn the controls clockwise to decrease attenuation, or counterclockwise to increase attenuation. The attenuator must be at 0 dB attenuation for the respective output to reach rated power.

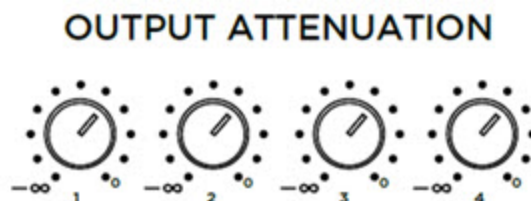

## Appendix C: ControlCenter Analog Zone Controller DIP Switch Configuration

When connecting to a PowerSpace+ amplifier, use the following DIP switch settings to configure ControlCenter analog zone controllers.

Up to four controllers can be connected directly to an amplifier's ControlCenter RJ-45 connector by daisy-chaining controllers, or by using the Bose ControlCenter CV41 4-to-1 Converter.

The CC-1 DIP switches assign an ID that must match the ID of the controller that is assigned to the listening area in the UI. Each CC-1 controller requires DIP switch 3 to be **ON**. Only one of the DIP switches 5, 6, 7, or 8 must be **ON** to match the ID assigned to the listening area in the UI. Set DIP switch 5 to **ON** for ID 1, DIP switch 6 to **ON** for ID 2, DIP switch 7 to **ON** for ID 3, or DIP switch 8 to **ON** for ID 4.

### CC-1 Controllers

#### One CC-1 controller:

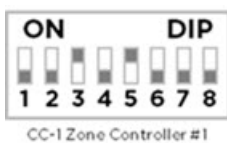

This single CC-1 is configured as **ID 1**.

#### Two CC-1 controllers:

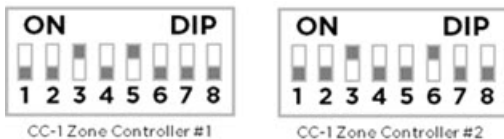

CC-1 #1 is configured as **ID 1** and CC-1 #2 is configured as **ID 2**.

#### Three CC-1 controllers:

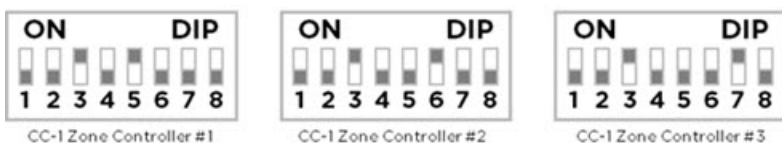

CC-1 #1 is configured as **ID 1**, CC-1 #2 is configured as **ID 2**, and CC-1 #3 is configured as **ID 3**.

#### Four CC-1 controllers:



CC-1 #1 is configured as **ID 1**, CC-1 #2 is configured as **ID 2**, CC-1 #3 is configured as **ID 3**, and CC-1 #4 is configured as **ID 4**.



## CC-2 Controllers

Up to two CC-2 controllers can be connected directly to an amplifier by daisy-chaining controllers, or by using the ControlCenter CV41 4-to-1 Converter.

The CC-2 DIP switches assign an ID that must match the ID of the controller that is assigned to the listening area in the UI.

**Note:** The CC-2 controller can only be configured as **ID 1** or **ID 2**.

### One CC-2 controller:

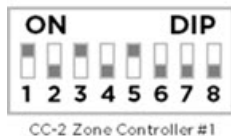

This single CC-2 is configured as **ID 1** with DIP switches 1, 3, and 5 **ON**.

### Two CC-2 controllers:

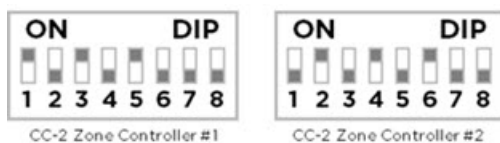

CC-2 #1 is configured as **ID 1** with DIP switches 1, 3, and 5 **ON** and CC-2 #2 is configured as **ID 2** with DIP switches 2, 4, and 6 **ON**.

**Note:** DIP switches 7 and 8 are not used on the CC-2.

## CC-3 Controller

Only one CC-3 controller can be connected to an amplifier and there are no DIP switches to set.

## CC-1 and CC-2 Controller Combinations

Up to four controllers can be connected directly to an amplifier by daisy-chaining controllers, or by using the ControlCenter CV41 4-to-1 Converter.

### One CC-1 controller and one CC-2 controller:

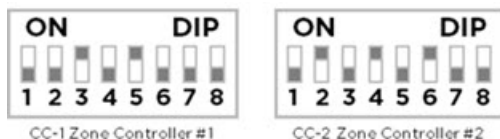

CC-1 is configured as **ID 1** and CC-2 as **ID 2**. The ID configurations can also be swapped where the CC-2 is **ID 1** and the CC-1 is **ID 2**.

### Two CC-1 controllers and one CC-2 controller:

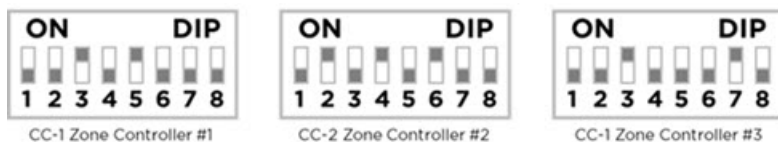

The CC-2 must be either **ID 1** or **ID 2** in this configuration. CC-1 #1 is configured as **ID 1**, CC-2 as **ID 2**, and CC-1 #2 as **ID 3**.

**One CC-1 controller and two CC-2 controllers:**

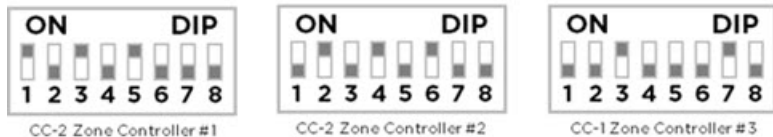

The two CC-2s must be **ID 1** and **ID 2** in this configuration. CC-2 #1 is configured as **ID 1**, CC-2 #2 as **ID 2**, and the CC-1 as **ID 3**.

**Three CC-1 controllers and one CC-2 controller:**



The CC-2 can only be **ID 2** in this configuration. CC-1 #1 is configured as **ID 1**, CC-2 as **ID 2**, CC-1 #2 as **ID 3**, and CC-1 #3 as **ID 4**.

## Appendix D: PowerSpace+ Amplifier Power States

Bose PowerSpace+ amplifiers have three possible power states:

Power State:	LED Status:
Full Power mode (ON)	Power LED is solid white.
Standby mode	Power LED and all other LEDs are off.
Auto Standby mode	Power LED blinks white.

**Note:** By default, Standby mode is the initial power state of a PowerSpace+ amplifier when it is plugged in for the first time.

### Standby Mode Options

Standby mode places the amplifier into a power-saving state, allowing the system to consume less power. You can use the following methods to place the amplifier into Standby mode:

Power State	Operation
Full Power mode (ON)	<p>When the amplifier is in Full Power mode, you can do one of the following to immediately place the amplifier into Standby mode:</p> <ul style="list-style-type: none"> <li>• Press the Power button on the front panel.</li> <li>• Enable the <a href="#">Standby Mode</a> option in the PowerSpace+ Configuration Utility.</li> </ul>
Standby mode	<p>The amplifier is immediately placed into Standby mode when the <b>Standby Mode</b> option is enabled in the PowerSpace+ Configuration Utility, or when the Power button is pressed while the amplifier is in Full Power mode.</p> <p>To exit Standby mode and place the amplifier into Full Power mode, you can:</p> <ul style="list-style-type: none"> <li>• Press the Power button on the front panel.</li> <li>• Disable the <a href="#">Standby Mode</a> option in the PowerSpace+ Configuration Utility.</li> </ul>
Auto Standby mode	<p>When the <b>Auto Standby</b> option is enabled in the PowerSpace+ Configuration Utility, the amplifier is automatically placed into Standby mode when the audio signal falls below a predefined threshold (-55 dBV) for 20 minutes. The amplifier automatically exits Standby mode (wakes), within 1 second, when an audio signal above the threshold is detected.</p> <p><b>CAUTION:</b> When using VOX paging, it is not recommended to enable Auto Standby because page signals may be truncated.</p> <p>To exit Standby mode and place the amplifier into Full Power mode, you can:</p> <ul style="list-style-type: none"> <li>• Press the Power button on the front panel. The amplifier will remain in Full Power mode unless the audio signal falls below the predefined threshold for 20 minutes, at which time the amplifier will return to Standby mode.</li> <li>• Disable the <a href="#">Auto Standby</a> option in the PowerSpace+ Configuration Utility.</li> </ul>

## **Power Outage Considerations**

In the event of a power outage or if the amplifier becomes unplugged, it will return to the last known power state when power is restored.

**Note:** *If Auto Standby mode is enabled and it placed the amplifier into Standby mode prior to a power loss, the amplifier will wake to Full Power mode when power is restored and will resume normal Auto Standby operation.*

# Licensing Information

## THIRD PARTY SOFTWARE AND NOTICES

The Software in Your Bose product or application contains portions that are copyrighted to Bose Corporation ("Bose"). The Software also utilizes as components certain Third Party Software packages that are copyrighted to their respective authors. Some of these Third Party Software packages are used in their original forms, and some are used in forms that have been modified by Bose. Furthermore, some of these Third Party Software packages are governed by the terms and conditions of so-called free or open source software licenses. Certain free or open source licenses give you certain rights to receive and use copies of the source code of some of the Third Party Software packages used in the Software, e.g. the GNU General Public License version 2, or the GNU Lesser General Public License version 2.1. Other open source licenses, such as the MIT License or the BSD License, merely require the licensee to print a copy of the license and distribute it with the associated software. For a general description of so-called free and open source software licenses, see [www.fsf.org](http://www.fsf.org) or [www.osi.org](http://www.osi.org).

If you would like to receive a copy of all of the Third Party software source code packages used in the Software that you are entitled to request from Bose, please mail a written request including the name, make, model and serial number (if any, and in each case to the extent applicable) of Your Bose Music product to: Licensing Manager, Bose Corporation, The Mountain, Mailstop 6A2 Framingham, MA 01701-9168.

Bose will distribute the applicable Third Party Software source code packages to you on a disk, USB drive, or other media customarily used for software exchange. Bose may impose a reasonable charge covering the cost of such distribution, such as the cost of media, shipping, and handling. This offer is valid for a period of not less than three (3) years following the date of distribution of the Software to you by Bose. Unless the terms of the associated free or open source licenses otherwise expressly require to the contrary, the applicable Third Party software source code package(s) are provided to you exclusively "as is", without warranty of any kind, whether express, implied or statutory, and Bose expressly disclaims any and all liability for any damages, claims, or losses arising out of your use, misuse, or inability to use such Third Party Software source code module(s).

?

1. MIT License. The following software packages are used as components in the Software and are governed by the terms of the MIT License reprinted below.

Software Package Name  
Copyright Information  
(where available)  
FreeRTOSV7.1.1

@ttskch/select2-bootstrap4-theme

axios

babel-polyfill

bootstrap

bootstrap-datepicker

bootstrap-timepicker

gaugeJS

jquery  
lodash  
lodash-inflexion  
moment  
nprogress  
numbro  
papaparse  
popper.js  
select2  
smoothscroll-polyfill  
toastr  
uuid  
vee-validate  
vue  
vue-router  
vue-slider-component  
vuex  
@vue/cli-plugin-babel  
@vue/cli-plugin-e2e-cypress  
@vue/cli-plugin-eslint  
@vue/cli-plugin-unit-jest  
@vue/cli-service  
@vue/eslint-config-standard  
@vue/test-utils  
babel-core  
babel-jest  
node-sass  
sass-loader  
Vue-template-compiler

#### MIT License

Permission is hereby granted, free of charge, to any person obtaining a copy of this software and associated documentation files (the "Software"), to deal in the Software without restriction, including without limitation the rights to use, copy, modify, merge, publish, distribute, sublicense, and/or sell copies of the Software, and to permit persons to whom the Software is furnished to do so, subject to the following conditions:

The above copyright notice and this permission notice shall be included in all copies or substantial portions of the Software.

THE SOFTWARE IS PROVIDED "AS IS", WITHOUT WARRANTY OF ANY KIND, EXPRESS OR IMPLIED, INCLUDING BUT NOT LIMITED TO THE WARRANTIES OF MERCHANTABILITY, FITNESS FOR A PARTICULAR PURPOSE AND NONINFRINGEMENT. IN NO EVENT SHALL THE AUTHORS OR COPYRIGHT HOLDERS BE LIABLE FOR ANY CLAIM, DAMAGES OR OTHER LIABILITY, WHETHER IN AN ACTION OF CONTRACT, TORT OR OTHERWISE, ARISING FROM, OUT OF OR IN CONNECTION WITH THE SOFTWARE OR THE USE OR OTHER DEALINGS IN THE SOFTWARE.

2. Apache 2.0 License. The following software packages are used as components in the Software and are governed by the terms of the Apache 2.0 License reprinted below.

Software Package Name  
Copyright Information  
(where available)  
mbed TLS

#### Apache License

Version 2.0, January 2004

<http://www.apache.org/licenses/>

#### TERMS AND CONDITIONS FOR USE, REPRODUCTION, AND DISTRIBUTION

##### 1. Definitions.

"License" shall mean the terms and conditions for use, reproduction, and distribution as defined by Sections 1 through 9 of this document.

"Licensor" shall mean the copyright owner or entity authorized by the copyright owner that is granting the License.

"Legal Entity" shall mean the union of the acting entity and all other entities that control, are controlled by, or are under common control with that entity. For the purposes of this definition, "control" means (i) the power, direct or indirect, to cause the direction or management of such entity, whether by contract or otherwise, or (ii) ownership of fifty percent (50%) or more of the outstanding shares, or (iii) beneficial ownership of such entity.

"You" (or "Your") shall mean an individual or Legal Entity exercising permissions granted by this License.

"Source" form shall mean the preferred form for making modifications, including but not limited to software source code, documentation source, and configuration files.

"Object" form shall mean any form resulting from mechanical transformation or translation of a Source form, including but not limited to compiled object code, generated documentation, and conversions to other media types.

"Work" shall mean the work of authorship, whether in Source or Object form, made available under the License, as indicated by a copyright notice that is included in or attached to the work (an example is provided in the Appendix below).

"Derivative Works" shall mean any work, whether in Source or Object form, that is based on (or derived from) the Work and for which the editorial revisions, annotations, elaborations, or other modifications represent, as a whole, an original work of authorship. For the purposes of this License, Derivative Works shall not include works that remain separable from, or merely link (or bind by name) to the interfaces of, the Work and Derivative Works thereof.

"Contribution" shall mean any work of authorship, including the original version of the Work and any modifications or additions to that Work or Derivative Works thereof, that is intentionally submitted to Licensor for inclusion in the Work by the copyright owner or by an individual or Legal Entity authorized to submit on behalf of the copyright owner. For the purposes of this definition, "submitted" means any form of electronic, verbal, or written communication sent to the Licensor or its representatives, including but not limited to communication on electronic mailing lists, source code control systems, and issue tracking systems that are managed by, or on behalf of, the Licensor for the purpose of discussing and improving the Work, but excluding communication that is conspicuously marked or otherwise designated in writing by the copyright owner as "Not a Contribution."

"Contributor" shall mean Licensor and any individual or Legal Entity on behalf of whom a Contribution has been received by Licensor and subsequently incorporated within the Work.

2. Grant of Copyright License. Subject to the terms and conditions of this License, each Contributor hereby grants to You a perpetual, worldwide, non-exclusive, no-charge, royalty-free, irrevocable copyright license to reproduce, prepare Derivative Works of, publicly display, publicly perform, sublicense, and distribute the Work and such Derivative Works in Source or Object form.
3. Grant of Patent License. Subject to the terms and conditions of this License, each Contributor hereby grants to You a perpetual, worldwide, non-exclusive, no-charge, royalty-free, irrevocable (except as stated in this section) patent license to make, have made, use, offer to sell, sell, import, and otherwise transfer the Work, where such license applies only to those patent claims licensable by such Contributor that are necessarily infringed by their Contribution(s) alone or by combination of their Contribution(s) with the Work to which such Contribution(s) was submitted. If You institute patent litigation against any entity (including a cross-claim or counterclaim in a lawsuit) alleging that the Work or a Contribution incorporated within the Work constitutes direct or contributory patent infringement, then any patent licenses granted to You under this License for that Work shall terminate as of the date such litigation is filed.
4. Redistribution. You may reproduce and distribute copies of the Work or Derivative Works thereof in any medium, with or without modifications, and in Source or Object form, provided that You meet the following conditions:



- (a) You must give any other recipients of the Work or Derivative Works a copy of this License; and
- (b) You must cause any modified files to carry prominent notices stating that You changed the files; and
- (c) You must retain, in the Source form of any Derivative Works that You distribute, all copyright, patent, trademark, and attribution notices from the Source form of the Work, excluding those notices that do not pertain to any part of the Derivative Works; and
- (d) If the Work includes a "NOTICE" text file as part of its distribution, then any Derivative Works that You distribute must include a readable copy of the attribution notices contained within such NOTICE file, excluding those notices that do not pertain to any part of the Derivative Works, in at least one of the following places: within a NOTICE text file distributed as part of the Derivative Works; within the Source form or documentation, if provided along with the Derivative Works; or, within a display generated by the Derivative Works, if and wherever such third-party notices normally appear. The contents of the NOTICE file are for informational purposes only and do not modify the License. You may add Your own attribution notices within Derivative Works that You distribute, alongside or as an addendum to the NOTICE text from the Work, provided that such additional attribution notices cannot be construed as modifying the License.

You may add Your own copyright statement to Your modifications and may provide additional or different license terms and conditions for use, reproduction, or distribution of Your modifications, or for any such Derivative Works as a whole, provided Your use, reproduction, and distribution of the Work otherwise complies with the conditions stated in this License.

5. Submission of Contributions. Unless You explicitly state otherwise, any Contribution intentionally submitted for inclusion in the Work by You to the Licensor shall be under the terms and conditions of this License, without any additional terms or conditions. Notwithstanding the above, nothing herein shall supersede or modify the terms of any separate license agreement you may have executed with Licensor regarding such Contributions.
6. Trademarks. This License does not grant permission to use the trade names, trademarks, service marks, or product names of the Licensor, except as required for reasonable and customary use in describing the origin of the Work and reproducing the content of the NOTICE file.
7. Disclaimer of Warranty. Unless required by applicable law or agreed to in writing, Licensor provides the Work (and each Contributor provides its Contributions) on an "AS IS" BASIS, WITHOUT WARRANTIES OR CONDITIONS OF ANY KIND, either express or implied, including, without limitation, any warranties or conditions of TITLE, NON-INFRINGEMENT, MERCHANTABILITY, or FITNESS FOR A PARTICULAR PURPOSE. You are solely responsible for determining the appropriateness of using or redistributing the Work and assume any risks associated with Your exercise of permissions under this License.

8. **Limitation of Liability.** In no event and under no legal theory, whether in tort (including negligence), contract, or otherwise, unless required by applicable law (such as deliberate and grossly negligent acts) or agreed to in writing, shall any Contributor be liable to You for damages, including any direct, indirect, special, incidental, or consequential damages of any character arising as a result of this License or out of the use or inability to use the Work (including but not limited to damages for loss of goodwill, work stoppage, computer failure or malfunction, or any and all other commercial damages or losses), even if such Contributor has been advised of the possibility of such damages.
9. **Accepting Warranty or Additional Liability.** While redistributing the Work or Derivative Works thereof, You may choose to offer, and charge a fee for, acceptance of support, warranty, indemnity, or other liability obligations and/or rights consistent with this License. However, in accepting such obligations, You may act only on Your own behalf and on Your sole responsibility, not on behalf of any other Contributor, and only if You agree to indemnify, defend, and hold each Contributor harmless for any liability incurred by, or claims asserted against, such Contributor by reason of your accepting any such warranty or additional liability.

END OF TERMS AND CONDITIONS

APPENDIX: How to apply the Apache License to your work.

To apply the Apache License to your work, attach the following boilerplate notice, with the fields enclosed by brackets "{}" replaced with your own identifying information. (Don't include the brackets!) The text should be enclosed in the appropriate comment syntax for the file format. We also recommend that a file or class name and description of purpose be included on the same "printed page" as the copyright notice for easier identification within third-party archives.

3. **2-Clause BSD License.** The following software packages are used as components in the Software and are governed by the terms of the two-clause BSD License reprinted below.

Software Package Name  
Copyright Information  
(where available)  
Lwip-1.4.1

2-Clause BSD License ("Simplified BSD License" or "FreeBSD License")

Copyright (c) <year>, <copyright holder>

All rights reserved.

Redistribution and use in source and binary forms, with or without modification, are permitted provided that the following conditions are met:

1. Redistributions of source code must retain the above copyright notice, this list of conditions and the following disclaimer.

2. Redistributions in binary form must reproduce the above copyright notice, this list of conditions and the following disclaimer in the documentation and/or other materials provided with the distribution.

THIS SOFTWARE IS PROVIDED BY THE COPYRIGHT HOLDERS AND CONTRIBUTORS "AS IS" AND ANY EXPRESS OR IMPLIED WARRANTIES, INCLUDING, BUT NOT LIMITED TO, THE IMPLIED WARRANTIES OF MERCHANTABILITY AND FITNESS FOR A PARTICULAR PURPOSE ARE DISCLAIMED. IN NO EVENT SHALL THE COPYRIGHT OWNER OR CONTRIBUTORS BE LIABLE FOR ANY DIRECT, INDIRECT, INCIDENTAL,

SPECIAL, EXEMPLARY, OR CONSEQUENTIAL DAMAGES (INCLUDING, BUT NOT LIMITED TO, PROCUREMENT OF SUBSTITUTE GOODS OR SERVICES; LOSS OF USE, DATA, OR PROFITS; OR BUSINESS INTERRUPTION) HOWEVER CAUSED AND ON ANY THEORY OF LIABILITY, WHETHER IN CONTRACT, STRICT LIABILITY, OR TORT (INCLUDING NEGLIGENCE OR OTHERWISE) ARISING IN ANY WAY OUT OF THE USE OF THIS SOFTWARE, EVEN IF ADVISED OF THE POSSIBILITY OF SUCH DAMAGE.

The views and conclusions contained in the software and documentation are those of the authors and should not be interpreted as representing official policies, either expressed or implied, of the <project name> project.

4. 3-Clause BSD License. The following software packages are used as components in the Software and are governed by the terms of the 3-Clause BSD License reprinted below.

Software Package Name

Copyright Information

(where available)

d3

3-Clause BSD License

(Also called "BSD License 2.0", "Revised BSD License", "New BSD License", or "Modified BSD License")

Copyright (c) <year>, <copyright holder>

All rights reserved.

Redistribution and use in source and binary forms, with or without modification, are permitted provided that the following conditions are met:

- \* Redistributions of source code must retain the above copyright notice, this list of conditions and the following disclaimer.
- \* Redistributions in binary form must reproduce the above copyright notice, this list of conditions and the following disclaimer in the documentation and/or other materials provided with the distribution.
- \* Neither the name of the <organization> nor the names of its contributors may be used to endorse or promote products derived from this software without specific prior written permission.

THIS SOFTWARE IS PROVIDED BY THE COPYRIGHT HOLDERS AND CONTRIBUTORS "AS IS" AND ANY EXPRESS OR IMPLIED WARRANTIES, INCLUDING, BUT NOT LIMITED TO, THE IMPLIED WARRANTIES OF MERCHANTABILITY AND FITNESS FOR A PARTICULAR PURPOSE ARE DISCLAIMED. IN NO EVENT SHALL <COPYRIGHT HOLDER> BE LIABLE FOR ANY DIRECT, INDIRECT, INCIDENTAL, SPECIAL, EXEMPLARY, OR CONSEQUENTIAL DAMAGES (INCLUDING, BUT NOT LIMITED TO, PROCUREMENT OF SUBSTITUTE GOODS OR SERVICES; LOSS OF USE, DATA, OR PROFITS; OR BUSINESS INTERRUPTION) HOWEVER CAUSED AND ON ANY THEORY OF LIABILITY, WHETHER IN CONTRACT, STRICT LIABILITY, OR TORT (INCLUDING NEGLIGENCE OR OTHERWISE) ARISING IN ANY WAY OUT OF THE USE OF THIS SOFTWARE, EVEN IF ADVISED OF THE POSSIBILITY OF SUCH DAMAGE.

5. MCD-ST Liberty SW License Agreement V2 - The following software packages are used as components in the Software and are governed by the terms of the Liberty V2 License reprinted below

Software Package Name

Copyright Information

(where available)

ST microcontroller - drivers and libraries

SLA0044 Rev5/February 2018

BY INSTALLING COPYING, DOWNLOADING, ACCESSING OR OTHERWISE USING THIS SOFTWARE OR ANY

PART THEREOF (AND THE RELATED DOCUMENTATION) FROM STMICROELECTRONICS INTERNATIONAL N.V, SWISS BRANCH AND/OR ITS AFFILIATED COMPANIES (STMICROELECTRONICS), THE RECIPIENT, ON BEHALF OF HIMSELF OR HERSELF, OR ON BEHALF OF ANY ENTITY BY WHICH SUCH RECIPIENT IS EMPLOYED AND/OR ENGAGED AGREES TO BE BOUND BY THIS SOFTWARE LICENSE AGREEMENT.

Under STMicroelectronics' intellectual property rights, the redistribution, reproduction and use in source and binary forms of the software or any part thereof, with or without modification, are permitted provided that the following conditions are met:

1. Redistribution of source code (modified or not) must retain any copyright notice, this list of conditions and the disclaimer set forth below as items 10 and 11.
2. Redistributions in binary form, except as embedded into microcontroller or microprocessor device manufactured by or for STMicroelectronics or a software update for such device, must reproduce any copyright notice provided with the binary code, this list of conditions, and the disclaimer set forth below as items 10 and 11, in documentation and/or other materials provided with the distribution.
3. Neither the name of STMicroelectronics nor the names of other contributors to this software may be used to endorse or promote products derived from this software or part thereof without specific written permission.
4. This software or any part thereof, including modifications and/or derivative works of this software, must be used and execute solely and exclusively on or in combination with a microcontroller or microprocessor device manufactured by or for STMicroelectronics.
5. No use, reproduction or redistribution of this software partially or totally may be done in any manner that would subject this software to any Open Source Terms. "Open Source Terms" shall mean any open source license which requires as part of distribution of software that the source code of such software is distributed therewith or otherwise made available, or open source license that substantially complies with the Open Source definition specified at [www.opensource.org](http://www.opensource.org) and any other comparable open source license such as for example GNU General Public License (GPL), Eclipse Public License (EPL), Apache Software License, BSD license or MIT license.
6. STMicroelectronics has no obligation to provide any maintenance, support or updates for the software.
7. The software is and will remain the exclusive property of STMicroelectronics and its licensors. The recipient will not take any action that jeopardizes STMicroelectronics and its licensors' proprietary rights or acquire any rights in the software, except the limited rights specified hereunder.
8. The recipient shall comply with all applicable laws and regulations affecting the use of the software or any part thereof including any applicable export control law or regulation.
9. Redistribution and use of this software or any part thereof other than as permitted under this license is void and will automatically terminate your rights under this license.
10. THIS SOFTWARE IS PROVIDED BY STMICROELECTRONICS AND CONTRIBUTORS "AS IS" AND ANY EXPRESS, IMPLIED OR STATUTORY WARRANTIES, INCLUDING, BUT NOT LIMITED TO, THE IMPLIED WARRANTIES OF MERCHANTABILITY, FITNESS FOR A PARTICULAR PURPOSE AND NON-INFRINGEMENT OF THIRD PARTY INTELLECTUAL PROPERTY RIGHTS, WHICH ARE DISCLAIMED TO THE FULLEST EXTENT PERMITTED BY LAW. IN NO EVENT SHALL STMICROELECTRONICS OR CONTRIBUTORS BE LIABLE FOR ANY DIRECT, INDIRECT, INCIDENTAL, SPECIAL, EXEMPLARY, OR CONSEQUENTIAL DAMAGES (INCLUDING, BUT NOT LIMITED TO, PROCUREMENT OF SUBSTITUTE GOODS OR SERVICES; LOSS OF USE, DATA, OR PROFITS; OR BUSINESS INTERRUPTION) HOWEVER CAUSED AND ON ANY THEORY OF LIABILITY, WHETHER IN CONTRACT, STRICT LIABILITY, OR TORT (INCLUDING NEGLIGENCE OR OTHERWISE) ARISING IN ANY WAY OUT OF THE USE OF THIS SOFTWARE, EVEN IF ADVISED OF THE POSSIBILITY OF SUCH DAMAGE.
11. EXCEPT AS EXPRESSLY PERMITTED HEREUNDER, NO LICENSE OR OTHER RIGHTS, WHETHER EXPRESS OR IMPLIED, ARE GRANTED UNDER ANY PATENT OR OTHER INTELLECTUAL PROPERTY RIGHTS OF STMICROELECTRONICS OR ANY THIRD PARTY.