

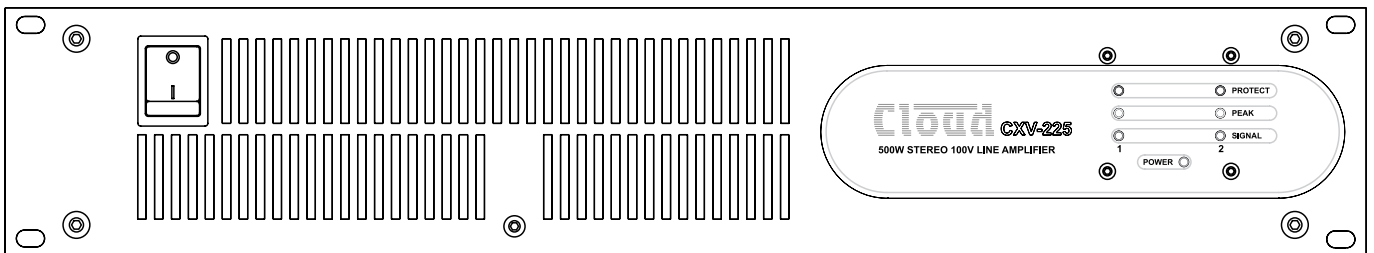

CXV-225 & CXV-425 AMPLIFIERS

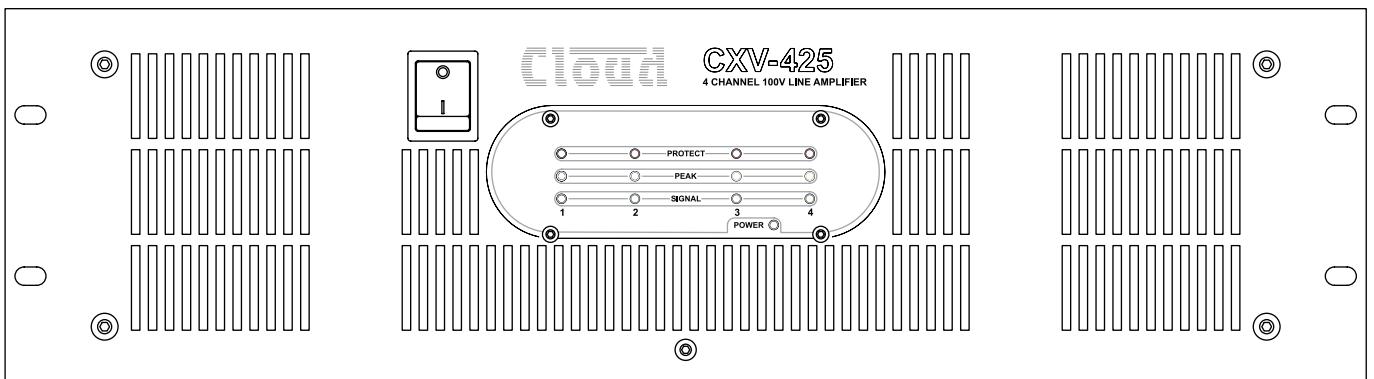

Installation and User Guide

Contents

Safety Information	4
Safety Notes Regarding Installation	4
Conformities.....	4
Safety Considerations and Information	4
General Description.....	5
Applicable Models.....	5
Schematic Diagram	5
Front Panel Description	6
Rear Panel Description.....	7
Installation	8
Mechanical	8
Ventilation.....	8
Connections and Adjustments	8
Inputs	8
Sensitivity and Gain Control.....	8
Input Routing.....	8
Remote Control of Level.....	9
Outputs.....	9
Protection.....	10
High Pass Filters.....	10
VCA Cards (optional).....	10
Installation	10
BOSE® Equalisation Modules (Optional).....	11
Installation	11
General Notes	11
EMC Considerations.....	11
Earthing.....	11
Technical Specifications.....	12
General Specifications	12
Location of Internal Jumpers and	
Connectors.....	13
CXV-225 connector and jumper details.....	13
CXV-425 connector and jumper details.....	14

Safety Information

Safety Notes Regarding Installation

- Do not expose the unit to water or moisture.
- Do not expose the unit to naked flames.
- Do not block or restrict any air vent.
- Do not operate the unit in ambient temperatures above 35 °C.
- Do not touch any part or terminal carrying the hazardous live symbol (⚡) while power is supplied to the unit.
- Do not perform any internal adjustments unless you are qualified to do so and fully understand the hazards associated with mains-operated equipment.
- The unit has no user-serviceable parts. Refer servicing to qualified service personnel.
- If the moulded plug is cut off the AC power lead for any reason, the discarded plug is a potential hazard and should be disposed of in a responsible manner.

Conformities

This product conforms to the following European EMC Standards:

BS EN 55103-1:1997

BS EN 55103-2:1997



This product has been tested for use in commercial and light industrial environments. If the unit is used in controlled EMC environments, the urban outdoors, heavy industrial environments or close to railways, transmitters, overhead power lines, etc., the performance of the unit may be degraded.

The product conforms to the following European electrical safety standard:

BS EN 60065:2002

The CXV Series was developed and manufactured with high quality materials and components, which can be recycled and/or reused.

Safety Considerations and Information

The unit must be earthed. Ensure that the mains power supply provides an effective earth connection using a three-wire termination.

When the mains switch is in the off 'O' position the live and neutral conductors of the mains transformer are disconnected.

Caution - High Voltages

Do not touch any part or terminal carrying the hazardous live symbol (⚡) while power is supplied to the unit.

Terminals to which the hazardous live symbol refers require installation by a qualified person.

Caution - Mains Fuse

Replace the mains fuse only with the same type and rating as marked on the rear panel.

The fuse body size is 20 mm x 5 mm.

Caution - Servicing

The unit contains no user-serviceable parts. Refer servicing to qualified service personnel. Do not perform servicing unless you are qualified to do so.

Disconnect the power cable from the unit before removing the top panel and do not make any internal adjustments with the unit switched on.

Only reassemble the unit using bolts/screws identical to the original parts.

General Description

The Cloud CXV-225 and CXV-425 are high power (250 W/ch), multi-channel audio amplifiers intended for use with high quality PA and background music systems in offices, hotels, factories, leisure facilities and other commercial and industrial premises.

They are designed to drive 100V line speaker systems directly, and have no low-impedance outputs. Low impedance loudspeakers can only be connected to these amplifiers with the use of an intermediate 100V line transformer. Loudspeakers designed for such 'installed-sound' applications will normally include an integral transformer, typically with selectable output power taps. If you have any doubt about the suitability of this amplifier for the speaker system it is to be connected to, please verify that the speakers are of the 100V line type with the manufacturer.

Unlike traditional 100V line amplifier designs, the CXV-225 and CXV-425 do not employ an output transformer. This produces a considerable saving in weight and a significant improvement in audio quality.

Applicable Models

This manual describes the installation and operation of the following models:

- Cloud CXV-225 2-channel amplifier – 2 x 250 W, 2U 19" rack unit
- Cloud CXV-425 4-channel amplifier – 4 x 250 W, 3U 19" rack unit

Apart from the number of channels and the units' physical dimensions and power consumption figures, the two models are otherwise identical for the practical purposes of installation and operation.

Schematic Diagram

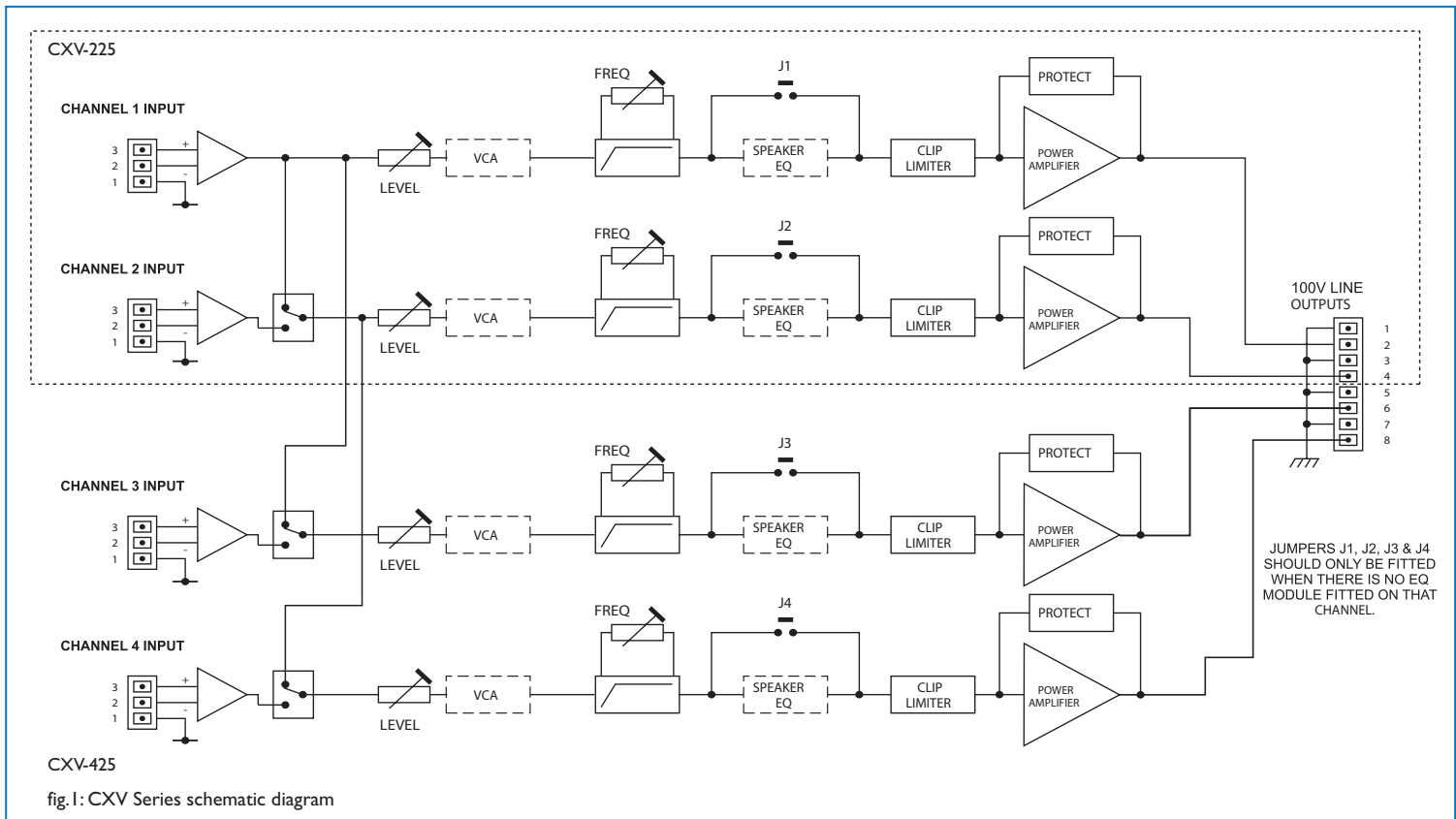

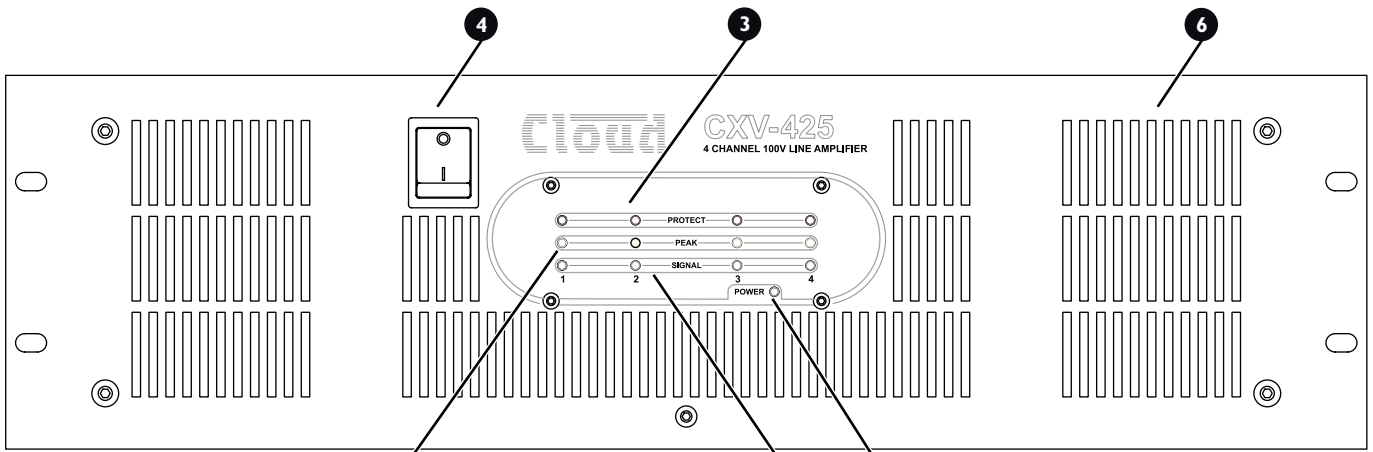

fig.2: CXV-425 Front panel

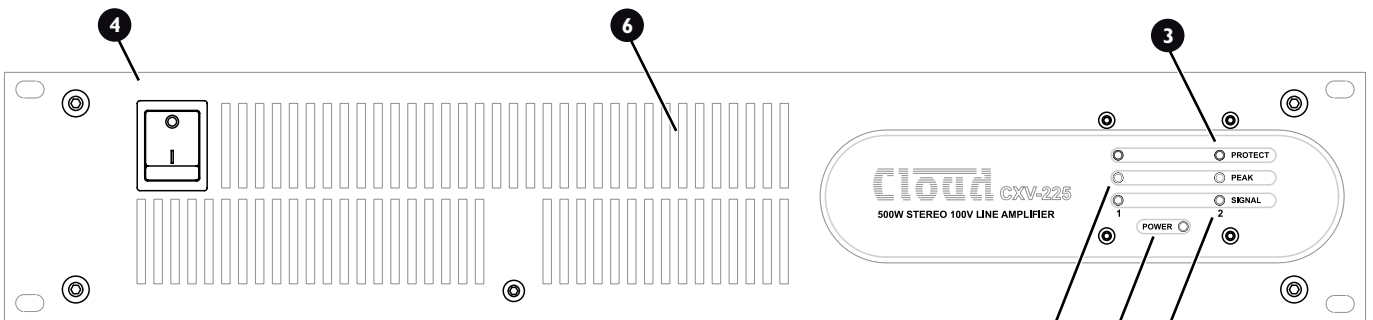

fig.3: CXV-225 Front panel



Front Panel Description

- ❶ **SIGNAL LEDs (one per channel)** – illuminate when the output voltage exceeds approx. 12.5Vrms (18 dB below maximum output)
- ❷ **PEAK LEDs (one per channel)** – illuminate if maximum output voltage is reached (100Vrms)
- ❸ **PROTECT LEDs (one per channel)** – indicate fault conditions

- ❹ **AC POWER SWITCH**
- ❺ **POWER LED**
- ❻ **AIR INTAKE GRILLES**

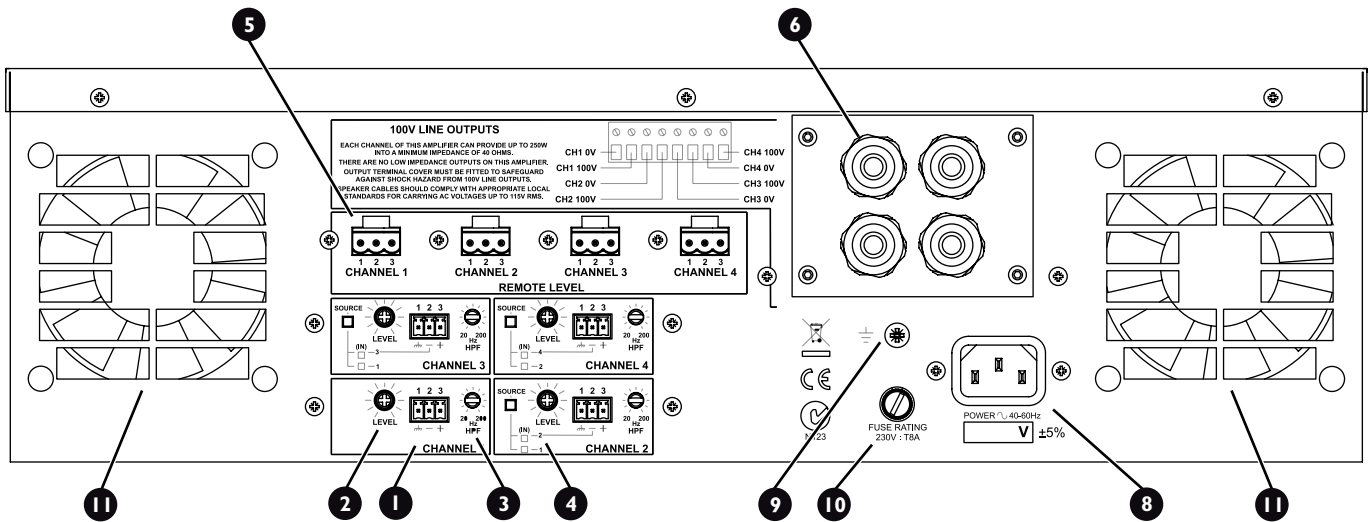

fig.4: CXV-425 Rear panel showing output terminal cover

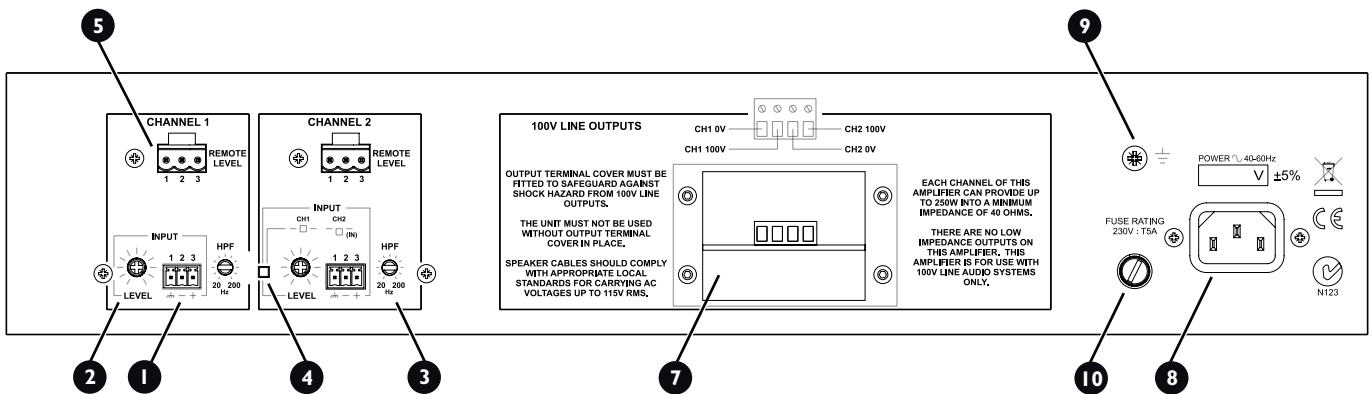

fig.5: CXV-225 Rear panel showing output terminals

Rear Panel Description

- ❶ INPUT CONNECTORS (one per channel)
- ❷ INPUT LEVEL CONTROLS (one per channel)
- ❸ HIGH PASS FILTER CONTROLS (one per channel)
- ❹ INPUT ROUTING SWITCHES – 1 for CXV-225, 3 for CXV-425
- ❺ REMOTE VOLUME CONTROL CONNECTORS – when remote control option is fitted (one per channel)
- ❻ OUTPUT TERMINAL COVER
- ❼ OUTPUT TERMINALS
- ❽ AC MAINS CONNECTOR
- ❾ EARTH SAFETY TAG
- ❿ MAINS FUSE
- ⓫ COOLING FANS AND AIR EXHAUST – CXV-425 only

Installation

Mechanical

The amplifiers are designed to be mounted in a standard 19" equipment rack. The front panel is fitted with rackmount ears for this purpose. The CXV-225 requires 2U of vertical rack space, the CXV-425 requires 3U. See notes below regarding spacing and ventilation.

Due to the units' weight, the use of additional side supports is recommended.

Ventilation

The CXV-425 is force cooled by two thermostatically-controlled fans mounted on the rear panel. The fan is operative at all times, remaining at low speed at internal temperatures below 50 °C, then increasing in speed above this temperature to a maximum speed at 70 °C.

The CXV-225 has a single fan mounted internally to keep noise to a minimum.

Always allow adequate space around the amplifier(s) to allow a free flow of air through the unit(s). Ensure that cable bundles or other items do not obstruct any grilles.

In 19" rack applications we recommend leaving 1U of rack space above and below each unit. Plain 1U blank panels, not slotted ventilation panels should be used, as the latter reduce the effect of forced-air cooling. The direction of airflow is from front-to-rear (CXV-425) and front-to-sides (CXV-225); it is recommended not to mix these amplifiers with other equipment employing forced-air cooling which acts in the opposite direction within the same rack.

Connections and Adjustments

Inputs

Each amplifier channel has an electronically-balanced input on a 3-pin 3.5 mm-pitch screw terminal connector. Twin-core screened cable should be used when driving the amplifier inputs from a device with a balanced output. Single-core screened cable can be used when connecting to an unbalanced source.

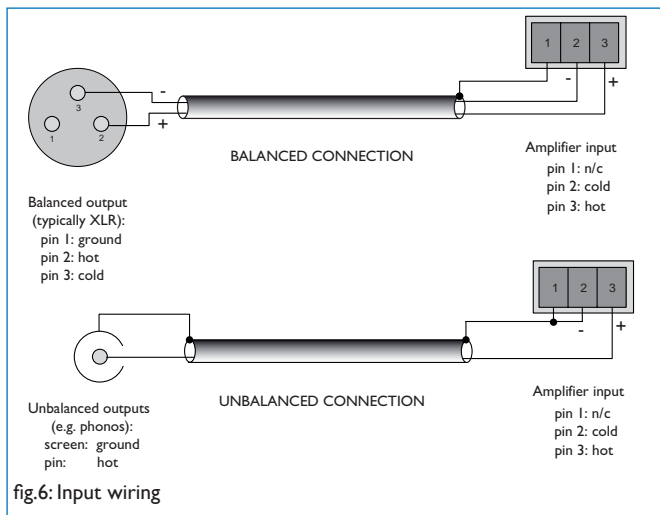

Sensitivity and Gain Control

Control of input level is provided by a preset rotary control adjacent to each input connector. The control should be adjusted using a trim tool or small screwdriver. Full attenuation of the input signal – i.e., zero output – is obtained with the control fully anti-clockwise. Maximum sensitivity is with the control fully clockwise; at this setting the maximum output level of 100Vrms will be produced for an input signal level of 0.775Vrms (0 dBu).

We recommend that the level for each channel should be adjusted after installation is complete to ensure that adequate, but not excessive sound levels are achieved with the programme material that will be used in practice.

Input Routing

To facilitate the use of the amplifiers in multi-zone applications, input selection switches are provided on all channels except Ch 1. This gives the installer an easy method of paralleling channels from a single input.

The options are summarised in the table below:

CHANNEL SOURCE	CXV-225		CXV-425	
	Out	In	Out	In
Channel 2	Input 1	Input 2	Input 1	Input 2
Channel 3			Input 1	Input 3
Channel 4			Input 2*	Input 4

* post Ch 2 switch

Refer also to the block diagram on page 5.

CXV-225 only: The CXV-225's single switch allows Channel 2 to be operated in parallel with Channel 1, with Input 1 acting as the common input connector.

CXV-425 only: The three switches on the CXV-425 allow a total of 8 routing possibilities, including 4-channel, dual stereo and mono operation with 4 channels paralleled. The table below clarifies the options:

BUTTON POSITION			INPUT ROUTING: CHANNELS FED BY EACH INPUT			
Ch 1	Ch 2	Ch 3	Input 1	Input 2	Input 3	Input 4
In	In	In	Ch 1	Ch 2	Ch 3	Ch 4
Out	In	In	Chs 1 & 2		Ch 3	Ch 4
In	Out	In	Chs 1 & 3	Ch 2		Ch 4
Out	Out	In	Chs 1, 2 & 3			Ch 4
In	In	Out	Ch 1	Chs 2 & 4	Ch 3	
Out	In	Out	Chs 1, 2 & 4		Ch 3	
In	Out	Out	Chs 1 & 3	Chs 2 & 4		
Out	Out	Out	Chs 1, 2, 3 & 4			

Remote Control of Level

The CXV-225 and CXV-425 amplifiers are compatible with standard Cloud remote control plates type RL-1, allowing control of level from a remote position. In order to use the amplifiers with the RL-1, VCA cards must first be fitted in the channels to be controlled remotely. See page 10 for details of VCA cards and fitting. Once VCA cards have been fitted, RL-1s may be connected at the rear 3-pin 5 mm-pitch screw terminal connectors (Remote Level), using the wiring shown below.

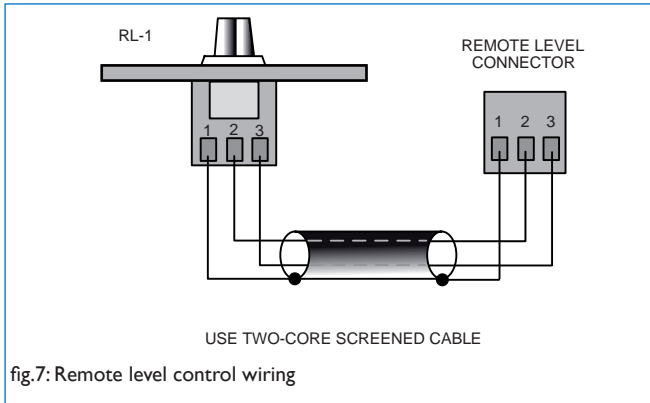

Use two-core screened cable to connect the remote level plate (maximum length 100 metres).

Outputs

The 100V line speaker output terminals are behind the removable output terminal cover (see page 7). The covers are fitted with a cable gland (one per channel); to use these, slacken the rear nut by a few turns and feed the cable through. The plug-in connectors are suitable for cable cores up to 2.5 mm².

Connect as shown below:

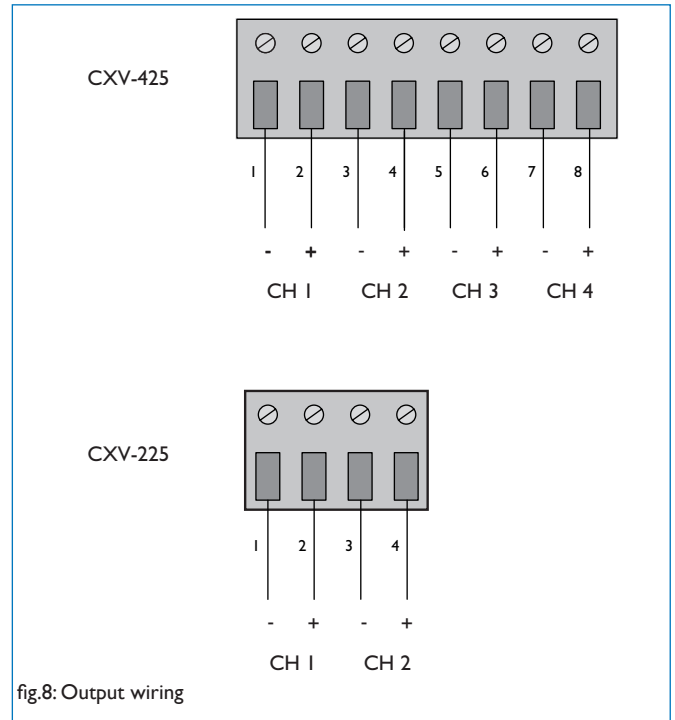

After making the connections, replace the cover and tighten the gland nuts. They only need to be firmly finger-tight; take care not to over tighten, use only enough torque to give reasonable cable retention. Do not use a spanner.

Caution: The amplifier should never be operated without the output terminal cover installed. Apart from exposing the high voltage terminals, leaving the cover off also compromises the amplifier’s forced-air cooling.

The amplifier’s transformerless output stage is designed to drive up to 100Vrms into an impedance of at least 40 ohms (each channel). Check the input impedance of the loudspeaker type in use and divide this figure by the number of loudspeakers* to ensure that the total impedance is greater than 40 ohms. Alternatively, add the wattages of all the loudspeakers being driven by each channel (taking power tapplings into account); the total must be less than 250 W.

* Assumes all loudspeakers in the system are of the same type and have the same tap setting.

Protection

The amplifiers include comprehensive protection circuitry to prevent damage to loudspeakers, the output devices and other components in the event of a fault condition.

Thermal Protection

The output device heatsink temperatures are monitored and the protection circuitry activated if any should exceed 90°C. The red front panel PROTECT LED for the appropriate channel illuminates to indicate the fault condition.

DC Protection

Crowbar protection is provided to safeguard the loudspeakers in the event of DC being present at the output terminals. This is an emergency protection feature that will only operate in the event of the amplifier developing a fault. Its action is liable to blow internal DC rail fuses. The amplifier must be serviced before any attempt is made to use it further.

Short-circuit protection

VI limiting is implemented in the amplifiers to protect the output stages from excessive dissipation caused by abnormal loads; for example, a short-circuit.

Switch-on protection

The protection circuitry is also activated immediately after the amplifier is switched on. This is to prevent any voltage spikes due to start-up conditions from damaging the loudspeakers. The protection circuitry automatically times out after approx. 5 seconds. All PROTECT LEDs illuminate at switch-on for the duration of the time-out period.

High Pass Filters

Most transformers fitted to 100V line speakers exhibit core saturation when fed with high-level signals at low frequencies. Transformer saturation creates unpleasant distortion and stresses the system. To counteract this, a correctly configured high pass filter is an essential part of any 100V line system. The CXV-225 and CXV-425 have variable frequency high pass filters in each channel, accessible at the rear panel (see page 7). These should be adjusted to reject low frequencies, to suit both the speakers and the application. When adjusting, bear in mind that the higher the frequency setting, the less likely it is that the system will suffer from saturation problems.

The minimum (20 Hz) setting should only be used when the system has some other form of filter or protection from high-level low frequency signals (e.g., a dedicated speaker processor) or when the speaker manufacturer explicitly states that they will operate correctly at such low frequencies.

For speech-only

Settings somewhere between 100 Hz (12 o'clock) and 200 Hz are appropriate. Start with the filter set to 100 Hz and turn the control clockwise whilst listening to speech through the system until you can hear a loss of bass in the voice. Few

voices contain any useful signal below 200 Hz, so in many cases the filter can be set to 200 Hz without any real loss of quality. Often a setting this high will actually enhance the clarity of the speech, reduce microphone handling noise and reduce breath blasts.

For music systems

The optimum filter setting will depend on the speakers and their transformers. It should be recognised that many 100V line speakers have inferior LF performance compared to low impedance speakers. If the manufacturer recommends a minimum frequency of operation, set the filter to this. Otherwise, settings between 70 Hz and 100 Hz should be appropriate.

Test the system at full volume with a variety of music containing high level, low bass notes and listen for any distortion. If the transformers saturate, distortion will be clearly audible. In this case, turn the control clockwise until it disappears.

VCA Cards (optional)

Cloud VCA-5 modules must be fitted to the CXV-225 and CXV-425 amplifiers if remote control of audio level is required. One VCA-5 module is required for each channel, and as many as necessary may be fitted. The VCA modules use the industry-standard That's 2181 VCA device, which provides very low distortion and up to 90 dB attenuation at cut-off.

The VCA module can also be used to provide muting by using an auxiliary relay connected to a fire alarm control panel. Please contact our technical department for further details.

Installation

- With the power turned off and the mains cable removed, remove the top panel.
- Refer to the pcb layout diagrams on page 13. Locate the VCA connector for the first channel being fitted, and remove the jumper joining one pair of pins.
- Unscrew the blanking plate from the rear panel.
- Remove and retain the M3 fixing screw adjacent to the connector, and fit the 35mm M3 hex spacer supplied with the VCA-5 in its place.
- Push the 10-way VCA plug onto the PCB connector, aligned so the cable enters it from the rear of the chassis. Check there is contact with all 10 pins.
- Locate the VCA module's 3-pin socket in the rear panel cut-out and secure using the M3 screw provided.
- Replace the top panel.

Once the VCA-5 modules have been installed, RL-1 remote level control plate(s) may be connected to the REMOTE LEVEL connector(s) on the rear panel.

BOSE® Equalisation Modules (Optional)

The CXV-225 and CXV-425 are compatible with Bose® Series II loudspeakers; a single-channel Bose® equalisation module may be fitted to as many channels as necessary. Equalisation modules for the following Bose® models are available:

- Panaray® MA12
- Panaray® 402-II, 502B and 502BEX
- Panaray® LT Series: Models 3302, 4402, 9402 and 9702
- Freespace® DS 16 range
- Freespace® Model 16
- Freespace® Model 32 range

Other modules are available; please enquire.

Installation

- With the power turned off and the mains cable removed, remove the top panel.
- Refer to the pcb layout diagrams on page 13. The modules plug into the white 12-pin connectors on the PCB. Note the header connectors on the PCB have two notches on one side only; these engage with lugs on the equalisation module's mating connector to ensure correct orientation.
- After fitting equalisation modules to any channel(s), the corresponding module bypass jumper(s) must be removed in order for the module to function. Refer to the pcb layout diagrams for jumper locations.
- Replace the top cover with the original screws after fitting

General Notes

EMC Considerations

CXV Series amplifiers fully conform to the relevant electromagnetic compatibility (EMC) standards and are technically well behaved. You should experience no problems interfacing units to other items of equipment and under normal circumstances, no special precautions need to be taken. If the unit is to be used in close proximity to potential sources of HF disturbance such as high power communication transmitters, radar stations and the like, it is suggested that input signal leads be kept as short as possible. Always use balanced interconnections wherever possible.

Earthing

When several mains powered units are connected together via their signal cables, there is a risk of one or more earth loops which may cause an audible hum on the system even with the gain controls set to minimum.

The 0V rail of a CXV Series amplifier is directly coupled to the chassis ground. No interconnection problems should be encountered, but if there is any hum or other extraneous noise when source equipment is connected, the situation can generally be remedied by observing the following guidelines:

- Always connect sources using balanced connections wherever possible, with the cable screen only connected at the receiving end (amplifier input).
- Use audio isolating transformers (readily available from trade suppliers) at the inputs if necessary. These will ensure that the amplifier is electrically isolated from the source equipment.
- The signal source units should be located as close as possible to the amplifiers and the metal housing of the various units should not be electrically connected together through the equipment rack. If this is a problem, rack isolating kits are available from specialist hardware suppliers. If the problem persists, try to connect all interconnected units, including power amplifiers, to a common power source to ensure a common ground is provided.

Technical Specifications

	CXV-225 & CXV-425
Outputs	100 Vrms; 250 W into 40 Ω min. load (per channel)
Frequency Response	20 kHz -0.6 dB; LF response dependent on filter setting
High Pass Filter	-3 dB @ 20 Hz – 200 Hz variable
Distortion	<0.04% @ 1 kHz & 1 dB below limiting, 40 Ω load
Crosstalk	-80 dB @ 10 kHz
Sensitivity	0.775 Vrms (0 dBu)
Input Impedance	10 kΩ balanced, 5 kΩ unbalanced
Noise (rms)	-96 dB, 22Hz - 22kHz, relative to 100 Vrms
Power Input	230 V ±5%
Fuse Rating	230 V, 5 A
Fuse Type	T5A, 20 mm x 5 mm 250V

General Specifications

	CXV-225	CXV-425
Inputs	Electronically balanced; 3-pin 2.5 mm-pitch plug-in screw terminal connectors	
Outputs	2-pin 5 mm-pitch plug-in screw terminal connectors	
Protection	Clip Limiting, VI Limiting, DC Offset, Thermal & switch-on delay	
Status Indicators	LED indicators on each channel for Signal, Peak & Protect	
Cooling	Force cooled; internal variable speed DC fan	Force cooled; two rear-mounted variable speed DC fans
Dimensions (mm, W x H x D)	482.6 x 88 (2U) x 300 (+ connectors)	482.6 x 132.5 (3U) x 332 (+ connectors)
Weight	8.8 kg net	21 kg net

Location of Internal Jumpers and Connectors.

CXV-225 connector and jumper details

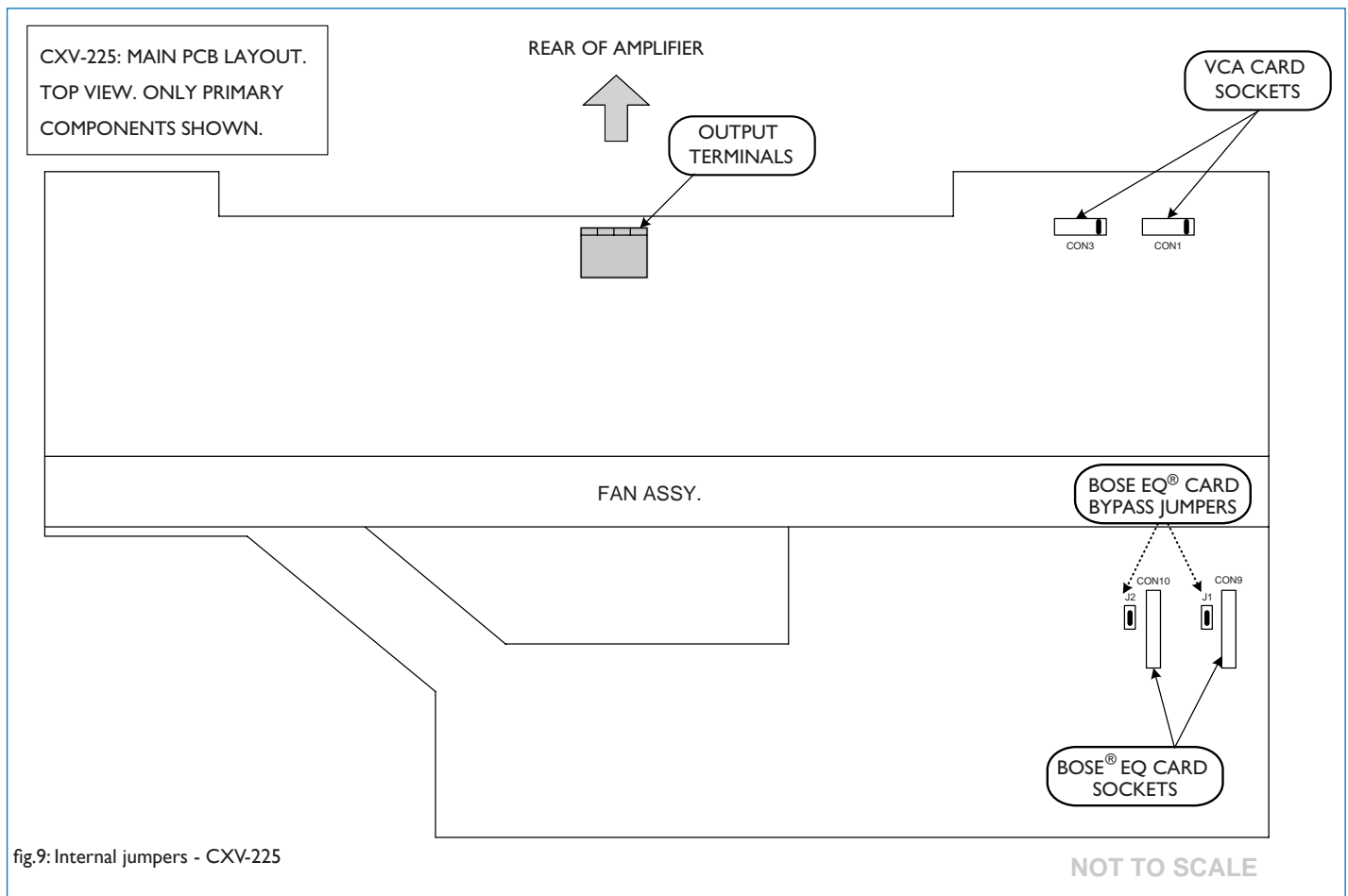

fig.9: Internal jumpers - CXV-225

MODEL	PCB REF	Function	Default Setting
CXV-225	CON1	CH1 VCA CARD	SET
	CON3	CH2 VCA CARD	SET
	CON9	CH1 BOSE® EQ CARD	
	CON10	CH2 BOSE® EQ CARD	
	J1	CH 1 EQ CARD BYPASS	SET
	J2	CH 2 EQ CARD BYASS	SET

CXV-425 connector and jumper details

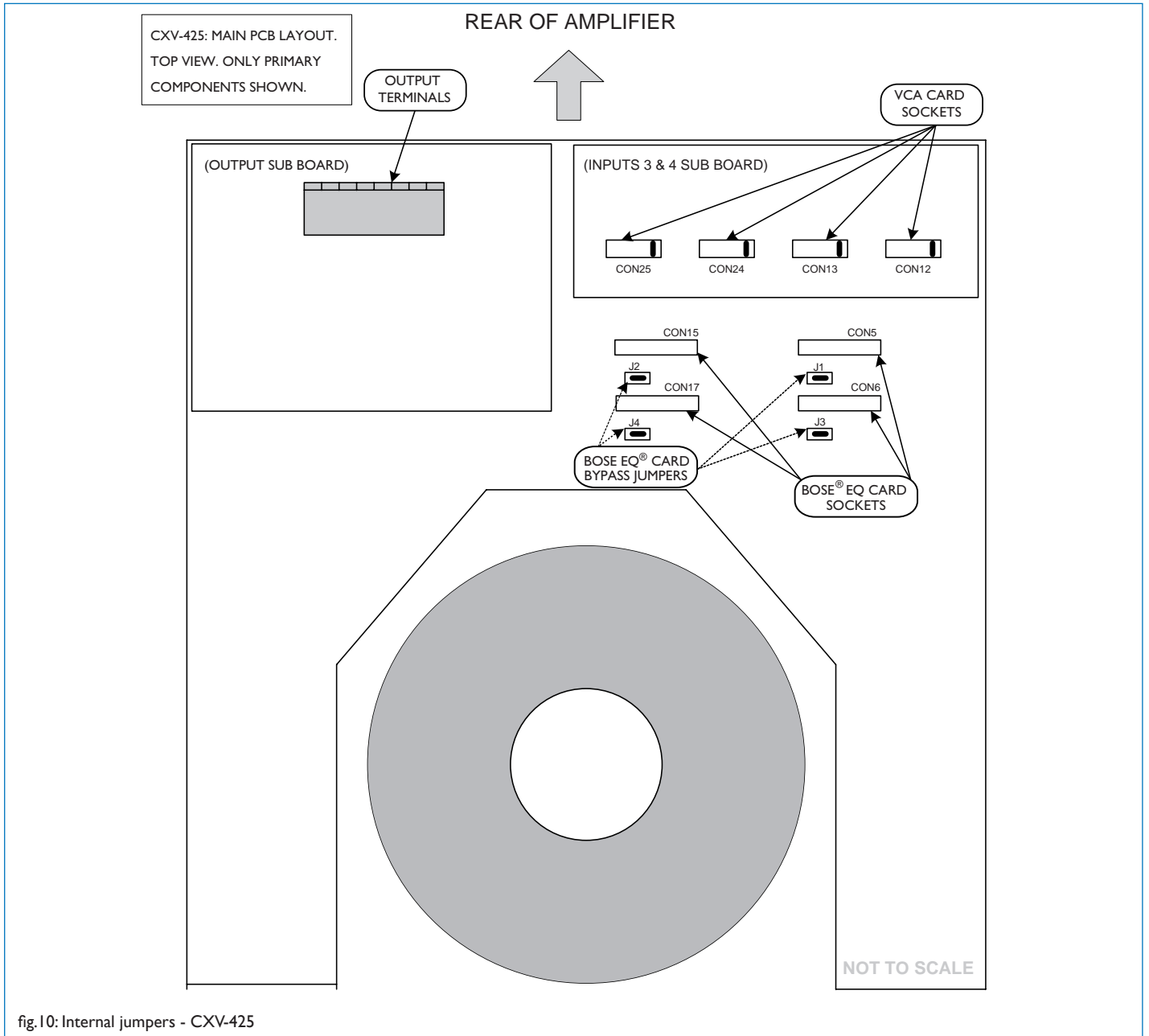

fig.10: Internal jumpers - CXV-425

MODEL	PCB REF	Function	Default Setting
CXV-425	CON12	CH1 VCA CARD	SET
	CON13	CH2 VCA CARD	SET
	CON24	CH3 VCA CARD	SET
	CON25	CH4 VCA CARD	SET
	CON5	CH1 BOSE® EQ CARD	
	CON6	CH2 BOSE® EQ CARD	
	CON15	CH3 BOSE® EQ CARD	
	CON17	CH4 BOSE® EQ CARD	
	J1	CH 1 EQ CARD BYPASS	SET
	J2	CH 2 EQ CARD BYPASS	SET
	J3	CH 3 EQ CARD BYPASS	SET
	J4	CH 4 EQ CARD BYPASS	SET

Bose® is a registered trademark of The Bose Corporation.

In the interest of continuing improvements Cloud Electronics Limited reserves
the right to alter specifications without prior notice.



Cloud Electronics Limited
140 Staniforth Road
Sheffield S9 3HF
England
Tel: +44 (0)114 244 7051
Fax: +44 (0)114 242 5462
email: info@cloud.co.uk
web: www.cloud.co.uk