



Ergonomic quick lock



Bushing with secure key



Overmolded ready made cable



1/4" flat tabs



1/4" flat tabs



UL recognized



ENEC certified

powerCON TRUE1 - Lockable 16 A single phase connector

NEW



NAC3FX



NAC3MX



NAC3FPX



NAC3MPX



NAC3PX

- True mains connector with breaking capacity (CBC)
- Lockable 16 / 20 A single phase connector
- Complete system with inlet and outlet connectors
- Unique duplex chassis connector - combines inlet and outlet coupler
- IP65 - water resistant ready-made cord sets
- ENEC certified according to IEC 60320
- Easy and reliable locking system
- UL recognized components

NAC3MPX

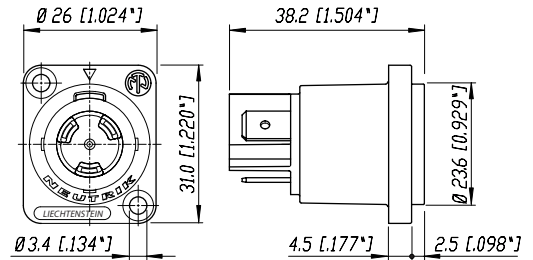

NAC3MX

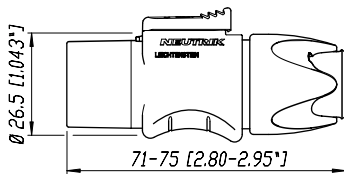

NAC3PX

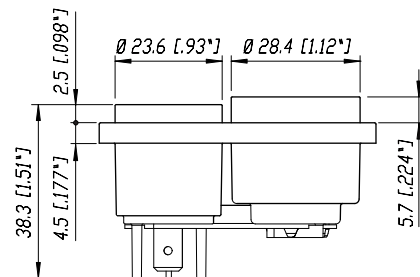

NAC3FPX

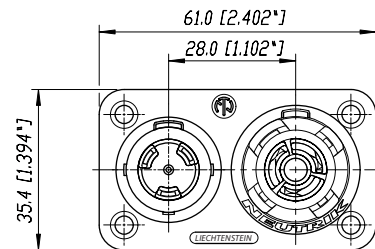
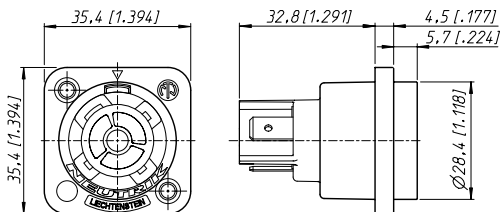

Ordering Information

Cable Connector

NAC3FX	Mains cable connector, female CBC, screw terminals
NAC3MX	Mains cable connector, male CBC, screw terminals
NKAC3F-x-y-z	Overmolded ready-made cable with NAC3FX on one side and
x ...	different length in m or ft
y ...	EU or US version (H05VV, SJT)
z ...	different termination on second end

Chassis Connector

NAC3FPX	Mains chassis connector female CBC, 1/4" flat tab terminals
NAC3MPX	Mains chassis connector male CBC, 1/4" flat tab terminals
NAC3PX	Mains chassis duplex, 1/4" flat tab terminals

Accessories



SCDP-*



SCNAC-PX



SCNAC-FPX



SCNAC-MPX

SCDP-*	D-Size sealing gaskets, colour coding
SCNAC-PX	Sealing cover duplex IP65
SCNAC-FPX	Sealing cover for NAC3FPX
SCNAC-MPX	Sealing cover for NAC3MPX

*: 0- black, 2- red, 4- yellow, 5- green, 6- blue, 9- white

Connector Assignment

APPLIANCE INLET

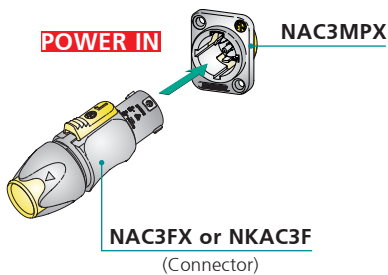

APPLIANCE COMBINATION

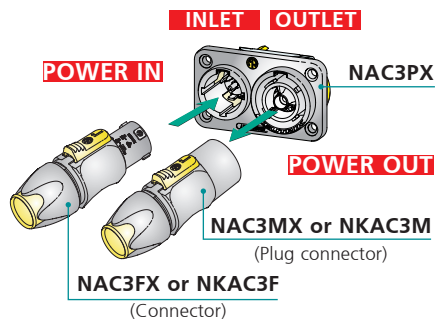

CABLE EXTENTION

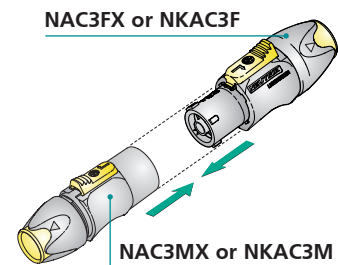

APPLIANCE OUTLET

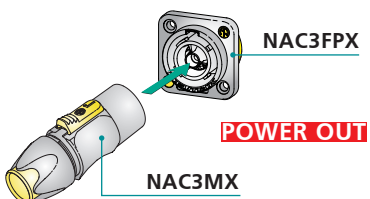

Specification

READY-MADE POWER CORDS

Ready-made overmolded power cord in protection class IP65. The cable utilizes standard duty cord with 3 conductors with cross section 1.5 mm² or 12 AWG.

Cables are equipped with Neutrik TRUE1 powerCON NAC3FXW and NAC3MXW for extension cables or with an

open end for termination of local connectors for "power in" supply cables. Overmolded local connectors on request. Cables are available in different lengths.

International Cord

International Power Cord 16 A / 250 VAC

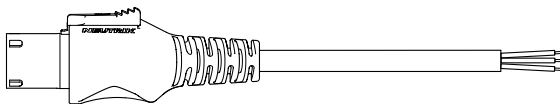

Current rating	16 A
Voltage rating	250 VAC
Cable type / color / Nom. O.D.	H05VVF3G1.5 / black / 8.0 mm
Conductor size	3 x 1.5 mm ²
Standard length	2 m, 3 m, 5 m
Plug / end termination	Neutrik NAC3FXW / stripped open end
Approvals	ENEC, VDE
Part Number e.g.	NKAC3F-WOC-3

International Power Cord 16 A / 250 VAC

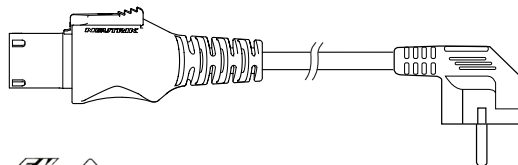

Current rating	16 A
Voltage rating	250 VAC
Cable type / color / Nom. O.D.	H05VVF3G1.5 / black / 8.0 mm
Conductor size	3 x 1.5 mm ²
Standard length	2 m, 3 m, 5 m
Plug / end termination	Neutrik NAC3FXW / SCHUKO RA
Approvals	ENEC, VDE
Part Number e.g.	NKAC3F-SR-3

International Extension Cord 16 A / 250 VAC

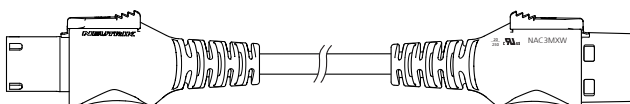

Current rating	16 A
Voltage rating	250 VAC
Cable type / color / Nom. O.D.	H05VVF3G1.5 / black / 8.0 mm
Conductor size	3 x 1.5 mm ²
Standard length	0.5 m, 1 m, 1.5 m
Plug / end termination	Neutrik NAC3FXW / Neutrik NAC3MXW
Approvals	ENEC, VDE
Part Number e.g.	NKAC3F-M-0.5

Cable Part Number Breakdown

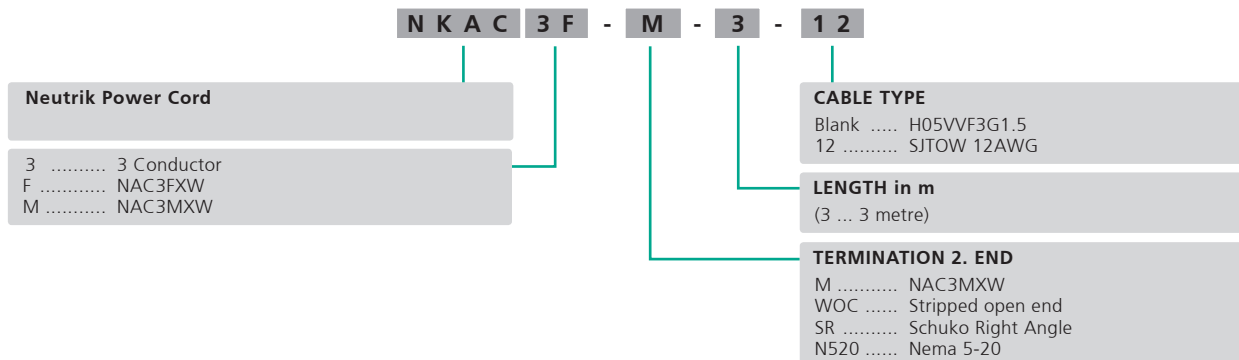

US Cord

US Power Cord 20 A / 250 VAC

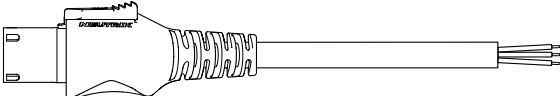

Current rating	20 A
Voltage rating	250 VAC
Cable type / color / Nom. O.D.	SJTOW / black / 11.3 mm
Conductor size	3 x 12 AWG
Standard length	2 m, 3 m, 5 m
Plug / end termination	Neutrik NAC3FXW / stripped open end
Approvals	UL, cUL
Part Number e.g.	NKAC3F-WOC-5-12

US Power Cord 20 A / 250 VAC

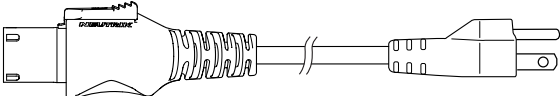

Current rating	20 A
Voltage rating	250 VAC
Cable type / color / Nom. O.D.	SJTOW / black / 11.3 mm
Conductor size	3 x 12 AWG
Standard length	2 m, 3 m, 5 m
Plug / end termination	Neutrik NAC3FXW / NEMA 5/15
Approvals	UL, cUL
Part Number e.g.	NKAC3F-N520-3-12

US Extension Cord 20 A / 250 VAC

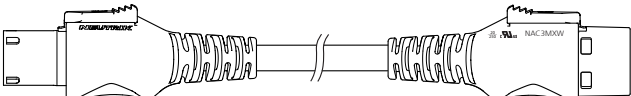

Current rating	20 A
Voltage rating	250 VAC
Cable type / color / Nom. O.D.	SJTOW / black / 11.3 mm
Conductor size	3 x 12 AWG
Standard length	0.5 m, 1 m, 1.5 m
Plug / end termination	Neutrik NAC3FXW / Neutrik NAC3MXW
Approvals	UL, cUL
Part Number e.g.	NKAC3F-M-1-12