



# FAST-FOLD **NXT**

FOR YOUR IMAGE™

**DA-LITE**®

# The Best is Better than Ever

We listened to you. We talked to buyers, business owners, product managers, end users, stage engineers and the technicians that set up rental screens every day.

We listened to what was important to you, and designed a work horse that is stronger, faster and simpler in the ways that make a difference. All delivered in a great looking product complete with foldable 4K optic capabilities, for your image.

## **We've Eliminated:**

- ⊘ Rivets
- ⊘ Snaps
- ⊘ Speedy Cranks
- ⊘ Sewing
- ⊘ Pull Tabs

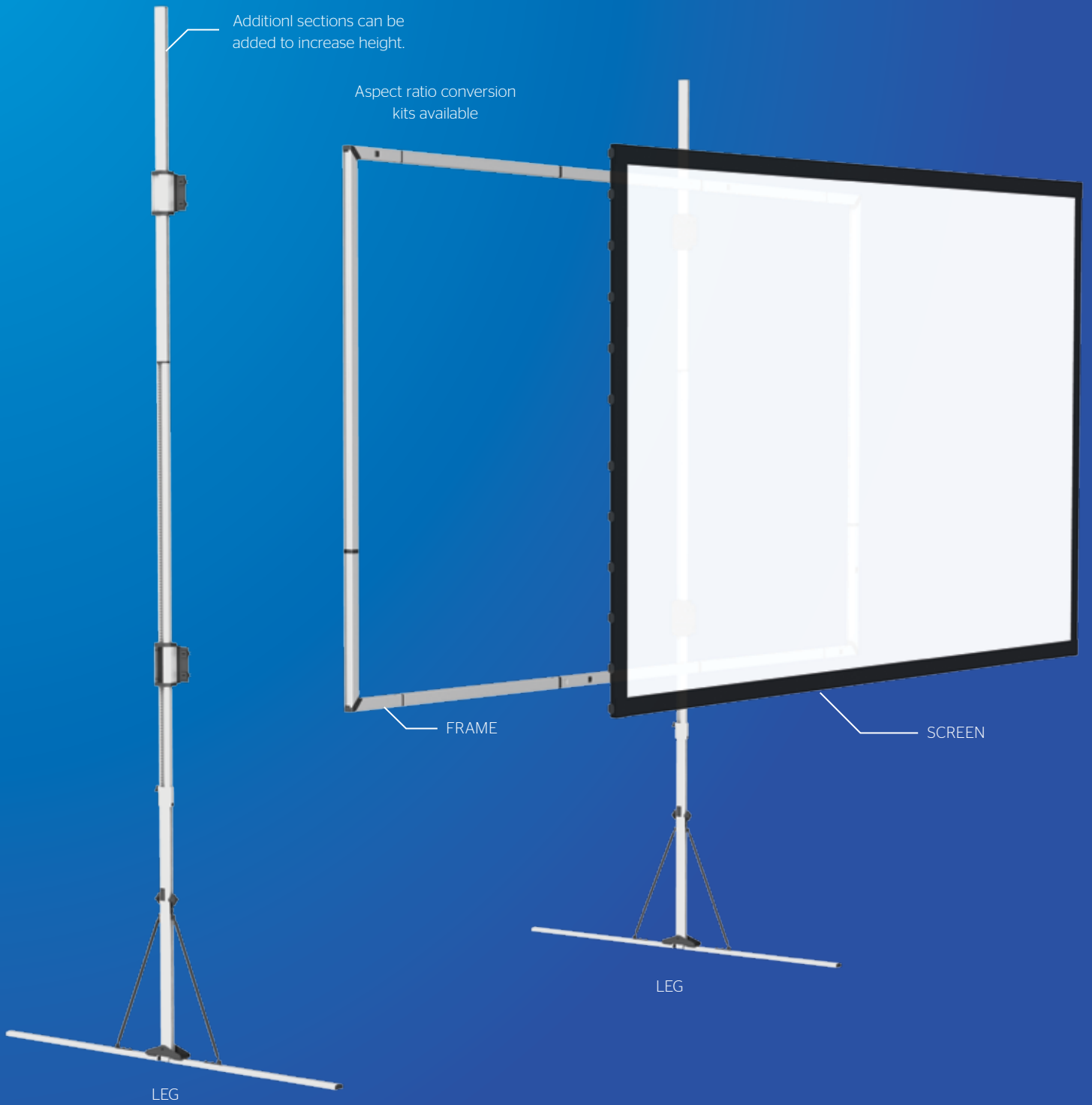

Simplified attachments to speed set up time.

# New Extrusion

- More aluminum means a slightly larger frame and more strength
- Channels give additional strength where you need it and prevent bowing
- Shape improves aesthetic of frame and streamlines accessories by centralizing the location of all attachments
- Fly any model with fly kit
- Orient any screen in portrait or landscape format

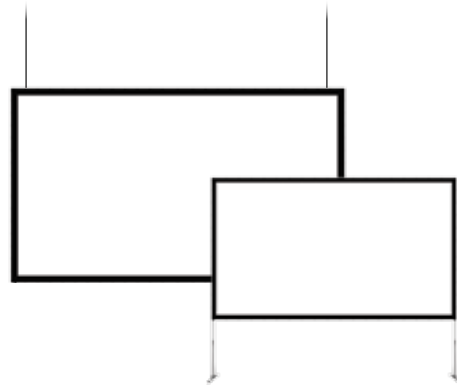

Universal frame design can both fly or be on legs

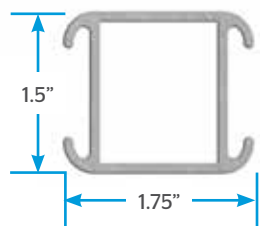

Standard Extrusion



Large Extrusion

# New Hinge

- Internal hinge improves durability and aesthetic
- Increased strength in design that uses epoxy instead of exposed rivets
- Push Button release for easy tear down

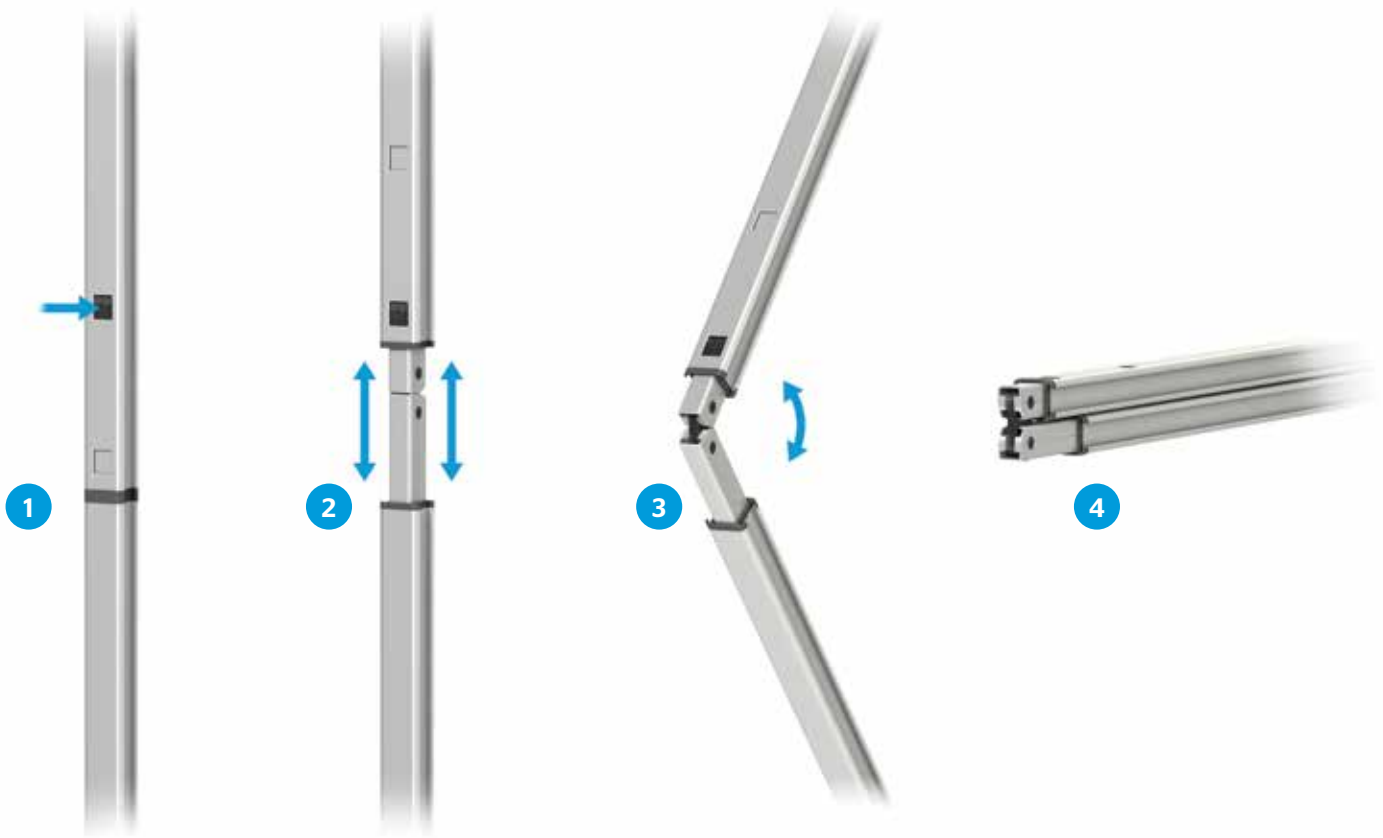

Frame easily folds down with the push of a button.

# New Corner

- Push Button release for easy tear down
- Fixed corner design improves durability
- Welded insert for additional reinforced strength
- Surface alignment that is the same every time

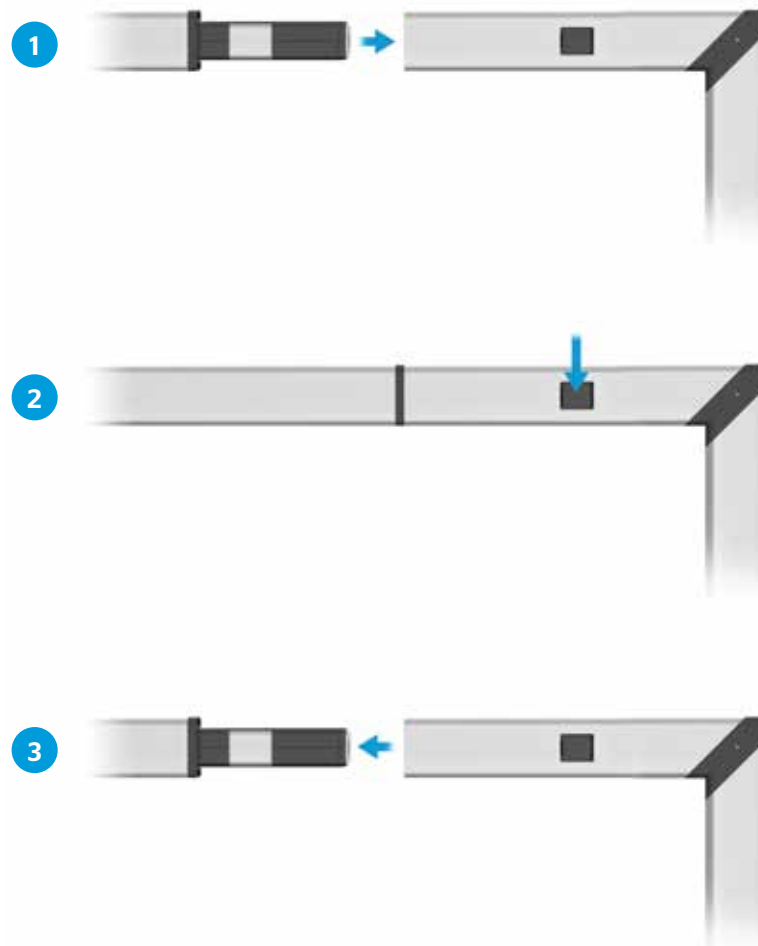

Frame easily tears down with the push of a button.

# New Legs

- No speedy cranks. Easily adjust screen height while screen is assembled and upright with micro-sawtooth height adjustment
- Easily add height adjustment sections when additional height is needed
- Latch-attach to frame
- Lower profile, gliding feet for moving the screen
- Independently leveling feet for uneven floors

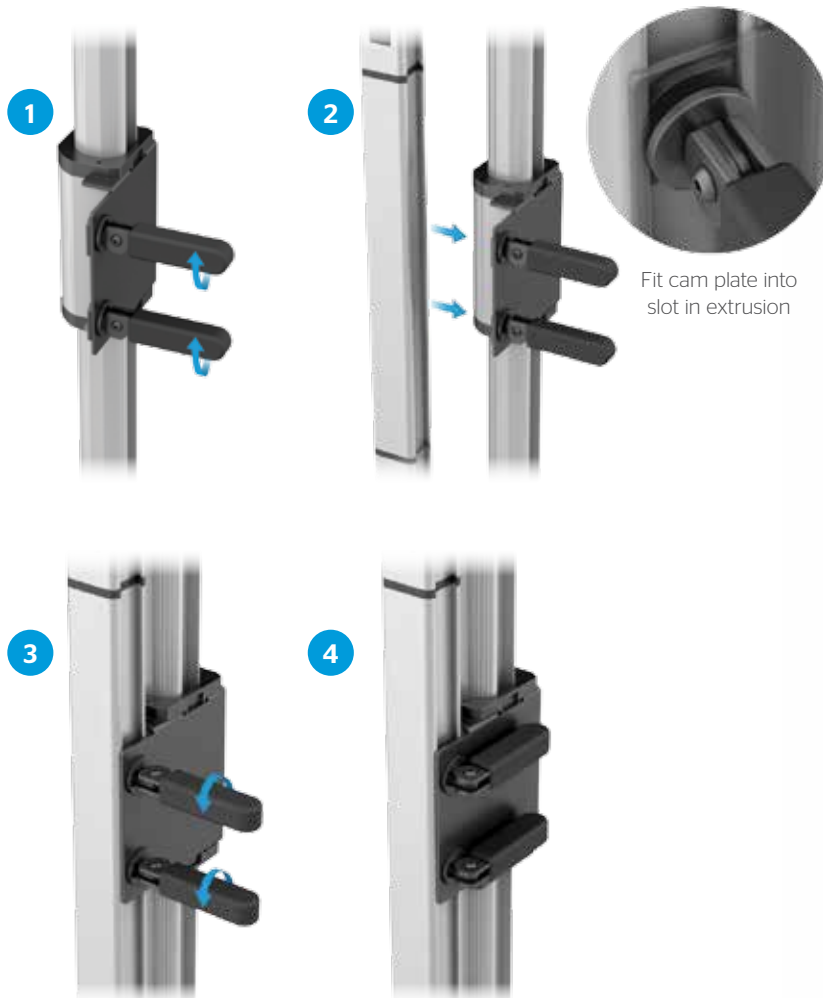

Attach legs to the frame in just four easy steps.



Simple height adjustment.

# New Reinforced Case

- Reinforced for increased strength
- Updated internal organization to protect surface and components
- New design featuring 4 wheels
- Designed to be stored upright or stacked horizontally
- New labeling system for quick identification
- Fewer case sizes for simplification





# New Surface Formulation

- Foldable, 4K-ready rental surface for HD and 4K projection - only from the chemists at Da-Lite pushing the Science of Surface
- Easy attachment with new clip design:



1 Wrap surface around frame



## HD Rental

Half Angle: 85° | Gain: 1.0  
Front Projection



2 Place outside edge of clip in channel



## Dual Vision

Half Angle: 65° | Gain: 0.9  
Rear Projection



3 Lock inside edge of clip into place



## Da-Tex

Half Angle: 30° | Gain: 1.3  
Rear Projection

# New Surface Binding

- New vinyl binding design replaces a woven binding and allows for easier attachment and flexibility
- Smaller 1" white binding wrap-around option for borderless viewing area
- RF weld for clean lines

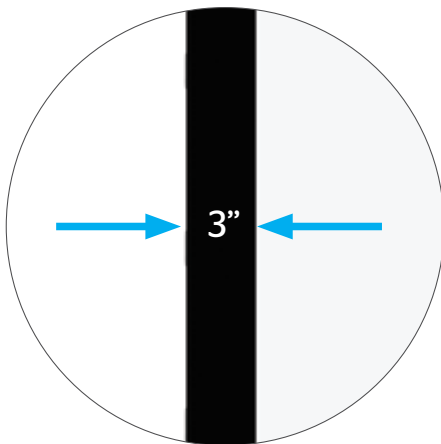

3" Black Border For Standard Sizes.

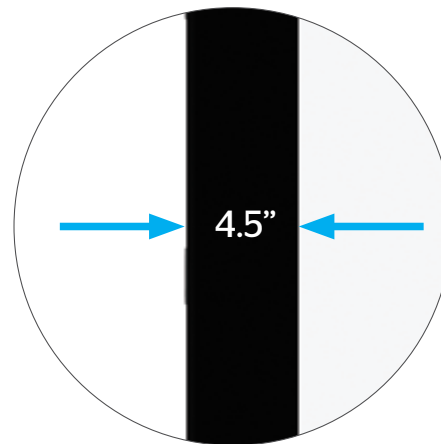

4.5" Black Border For Larger Sizes.

# Available Sizes

- Frames available up to 16' wide with standard extrusion
- Frames available up to 27.5' wide with large extrusion

## STANDARD SIZES

### HDTV (16:9) Format

VIEWING AREA (H X W in.)	VIEWING AREA (H X W cm)	DIAGONAL (in.)	DIAGONAL (cm)
52" x 92"	132 x 234	106"	269
58" x 104"	147 x 264	119"	302
65" x 116"	165 x 295	133"	338
79" x 140"	201 x 356	159"	404
90" x 160"	229 x 406	184"	467
108" x 192"	274 x 488	220"	559

### Wide (16:10) Format

VIEWING AREA (H X W in.)	VIEWING AREA (H X W cm)	DIAGONAL (in.)	DIAGONAL (cm)
58" x 92"	147 x 234	109"	277
65" x 104"	165 x 264	123"	312
73" x 116"	185 x 295	137"	348
88" x 140"	224 x 356	165"	419
102" x 164"	259 x 417	189"	480
120" x 192"	305 x 488	226"	574

## LARGE SIZES

### HDTV (16:9) Format

VIEWING AREA (H X W ft./in.)	VIEWING AREA (H X W cm)	DIAGONAL (in.)	DIAGONAL (cm)
7'6" x 13'4"	229 x 406	184"	467
9' x 16'	274 x 488	220"	559
10' x 18'	305 x 549	245"	622
10'6" x 18'8"	320 x 569	257"	653
11'3" x 20'	343 x 610	275"	699
12' x 21'4"	366 x 650	294"	747
13'6" x 24'	411 x 732	340"	864
15' x 26'6"	457 x 808	367"	932

### Wide (16:10) Format

VIEWING AREA (H X W ft./in.)	VIEWING AREA (H X W cm)	DIAGONAL (in.)	DIAGONAL (cm)
8'4" x 13'4"	254 x 406	189"	480
10' x 16'	305 x 488	226"	574
11'3" x 18'	381 x 610	255"	648
12'6" x 20'	381 x 610	283"	719
13'4" x 21'4"	406 x 650	302"	767
15' x 24'	457 x 732	340"	864
16'6" x 26'6"	503 x 808	375"	953



**A BRAND OF MILESTONE AV TECHNOLOGIES** | [www.milestone.com](http://www.milestone.com)

**P** 800.622.3737 / 574.267.8101 **F** 877.325.4832 / 574.267.7804

**E** [info@da-lite.com](mailto:info@da-lite.com)

In British Columbia, Milestone AV Technologies ULC carries on business as MAVT Milestone AV Technologies ULC.

©2017 Milestone AV Technologies. DL-0641 1017

Da-Lite is a registered trademarks of Milestone AV Technologies. All other brand names or marks are used for identification purposes and are trademarks of their respective owners. All patents are protected under existing designations. Other patents pending.

**milestone**™

Milestone AV Technologies is home of Chief, Da-Lite, Sanus and Projecta. Across these brands, Milestone produces a wide range of innovative audiovisual solutions.