

ControlCenter CC-3 zone controller



Product Description

Bose® ControlCenter CC-3 zone controllers provide volume control and A/B/C/D source selection for ControlSpace® products. They are available in either black or white and fit 1-gang electrical boxes in North America, Europe, and Japan. The zone controllers use an RJ-45 connector and Cat 5 wiring for simplified wiring.

Key Features

- **ControlCenter Series** – Remote end-user interfaces for use with Bose FreeSpace® amplifiers, PowerShare amplifiers and ControlSpace®, processors. Three control configurations offer volume control (CC-1), volume plus A/B source selection (CC-2) and volume plus A/B/C/D source selection (CC-3).
- **Variant Options** – Available in white or black and is offered in North American, Japanese, and EU form-factors to adapt to common electrical box sizes.
- **Support for Decora®-style wall plates** – North American and Japanese models are designed for use with Decora-style wall plate covers (not included). The 86×86 mm European model is supplied as a finished wall plate that supports 60 mm screw spacing.
- **Custom Labels** – Each zone controller includes a sheet of pre-printed labels, with two blanks for custom labeling.

Technical Specifications

Electrical	
Connector	One RJ-45, TIA/EIA 568B wiring standard
Settings	None
Type	Passive controller, linear potentiometer 0- 10 kΩ and 4-position switch
Cable Requirement	Cat 5
Maximum Cable Length	152 m (500 ft), using shielded cable 30 m (100 ft), using unshielded cable
Physical	
Colors	Black or White
Electrical Box Size	1-gang
General	
Product Codes	768941-0110 ControlCenter CC-3 US Black 768941-0210 ControlCenter CC-3 US White 768941-2110 ControlCenter CC-3 EU Black 768941-2210 ControlCenter CC-3 EU White 768941-3110 ControlCenter CC-3 JP Black 768941-3210 ControlCenter CC-3 JP White
Compatible With	ControlSpace ESP-00 II engineered sound processor ControlSpace ESP-880, ESP-1240 engineered sound processors ControlSpace ESP-4120, ESP-1600 engineered sound processors
Box Contents	(1) controller, (1) color-matched pre-printed label sheet, (2) mounting screws, (1) installation guide



Applications

- Retail stores
- Restaurants and bars
- Hospitality venues
- Religious and worship facilities
- Auxiliary zones

ControlCenter CC-3 zone controller



Connector Panel

Label area:
For preprinted (included)
or custom labels.

Volume knob:
Linear-taper 10 kΩ potentiometer.
Full clockwise is maximum output
(0 Ω), full counterclockwise is
mute (10 kΩ).

Device connection:
RJ-45 connection for use
with Cat 5 cable.

Source selection switch:
Remote switching of
A/B/C/D sources.

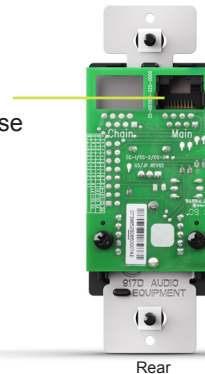

Mechanical Files

CC-3, US

CC-3, Japan

CC-3, EU

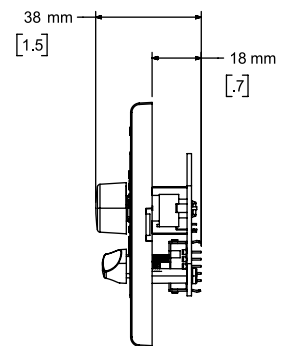
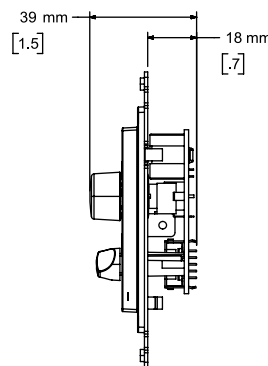
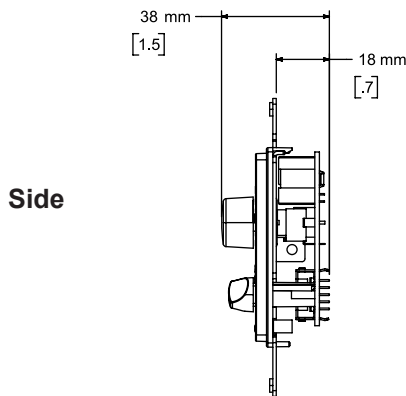
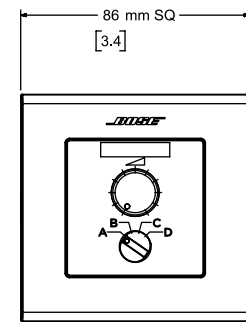
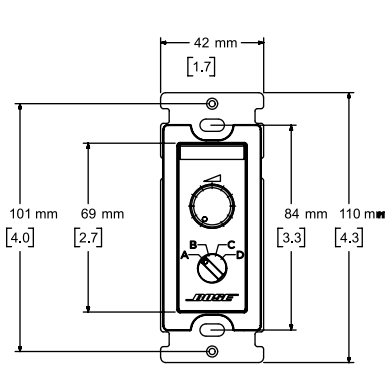
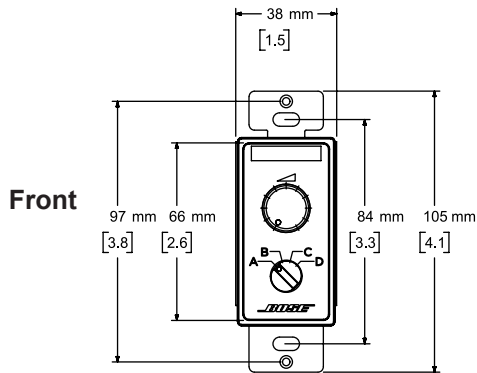

All information subject to change without notice.
© 2016 Bose Corporation
All trademarks are those of their respective owners.