

CLOUD 46-120, 46-120MEDIA, 46-120T, 46-120TMEDIA 4-ZONE INTEGRATED MIXER AMPLIFIERS

482.6 mm, 19"

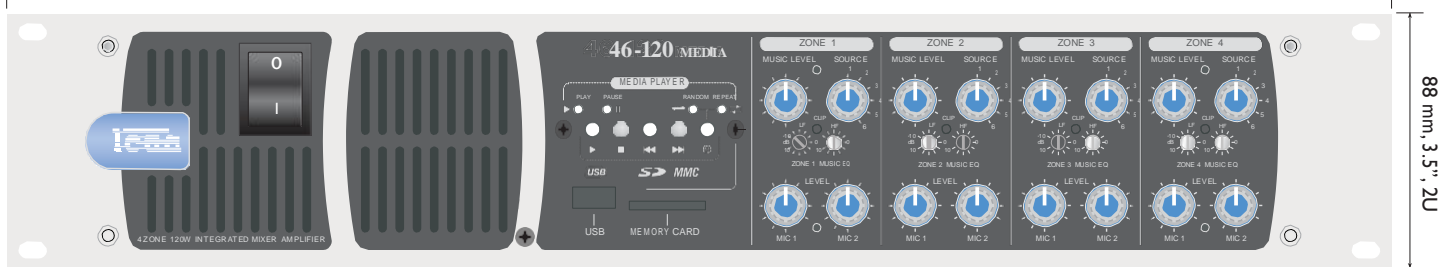

46-120MEDIA - front panel view

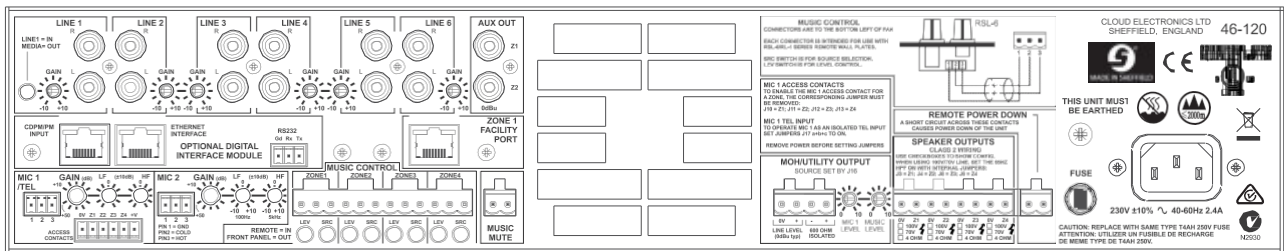

46-120MEDIA - rear panel view (shown with optional CDI-46 Digital Interface card fitted)

General Description

The Cloud 46-120MEDIA is a versatile four-zone, rack-mounting (2U) audio mixer amplifier combined with an integral digital media player. Reliable and compact, it combines a self-contained source of background music with microphone paging and power amplification (4 x 120 W) for up to four zones in a single unit. It is suitable for use in many types of premises, such as pubs, restaurants, bars, clubs and other entertainment locations, and also leisure and fitness centers, shops, offices, hotels, etc.

The 46-120 has all of the features and facilities of the 46-120MEDIA, but without the internal digital media player. It is ideal for any application where a powerful and versatile multi-zone mixer amplifier is required.

Both models have six stereo line inputs and two microphone inputs. Any one of the music sources may be user-selected, and mixed with the microphone inputs. Phantom power is available at the mic inputs, and one mic input can be configured either as a paging mic input, or as an analogue telephone system interface (an isolating transformer may be inserted by internal jumpers), permitting paging announcements to be made from telephone extensions (providing the system uses a compatible PBX). Each line and mic input has its own preset sensitivity control on the rear panel, and each mic input additionally has HF/LF EQ adjustment to optimise the inputs for greatest clarity.

Line 6 input may be set to have priority over any other selected music source in Zone 1, to facilitate connection of a jukebox, digital sound store or similar device. The priority feature has selectable release times, to allow a smooth return to the original music source.

On the 46-120MEDIA, the internal media player may be selected as the Line 1 source. It can play MP3 and WMA files directly from a USB device or SD memory card. All standard data rates and sampling frequencies are supported.

The mixer amplifiers have four mono zone outputs. On both models, each output has a 120 W power amplifier suitable for low-impedance loads. Alternative versions (the 46-120T and 46-120TMEDIA) are available with per-channel transformers (Model CXL-46T) fitted internally to allow 100/70 V-line systems to be driven. Transformers may also be retro-fitted to any or all channels of the standard versions, or individually by-passed in the 'T' versions. Pre-power stage outputs (0 dBu, unbalanced) are provided for Zones 1 and 2. EQ cards to suit popular installation speakers from various manufacturers may be fitted to any or all outputs.

A transformer-isolated auxiliary output is also available which may be used as an interface to telephone MOH systems, or as a utility output to drive a local rack monitor or an induction loop amplifier. This output may be selected by internal jumper to either follow Zone 1's selected music source summed with Mic 1, be permanently fed with any one of the music sources, including the media player in the 46-120MEDIA. Separate rear panel preset controls are provided to set the music and Mic 1 levels at this output.

The front panel provides separate user controls for adjusting the level of each mic input, music source selection and music level, for each zone. Each zone has a clip limiter to prevent excessive audio levels; CLIP LEDs illuminate when the limiting is active. Preset controls for HF and LF EQ adjustment of each zone output are also fitted.

The front panel of the 46-120MEDIA also has a socket for a standard SD memory card, and a USB port for connection of external data drives or other media. A conventional set of "transport" buttons allows Start and Stop, Next and Previous Track/File, and selection of Random and Repeat modes.

General Description (continued)

When fitted with the optional CDI-46 Digital Interface card (see below), the mixer amplifiers are directly compatible with all Cloud PM Series paging microphones via the card's Cloud Digital Paging Mic interface; alternatively, Mic 1 input can be configured to suit most OEM paging systems. Zone selection for paging is via short-to-ground access connections, and the unit may be configured by internal jumper for automatic music ducking (mic-over-music priority), triggered by VOX control.

A particularly useful feature of the 46-120 and 46-120MEDIA is the Zone 1 Facility Port; this allows one or more LM-2 Series remote input modules to be connected to the host unit via easy-to-install screened Cat 5 cable. Microphones, and/or line sources – such as radio mics, DJ mixers, MP3 players, laptops or other audio sources – can then be connected in the zone itself, simplifying the use of an area of the premises for presentations or other special functions where mics or portable audio sources are in use.

Music level only, or music level and source selection may be controlled remotely in any or all zones if wished, using standard Cloud RL or RSL Series remote control plates. Remote control of all the mixer amplifiers' functions may be obtained by fitting the optional CDI-46 Digital Interface card, allowing the units to be connected to control systems such as Crestron, AMX, etc, using either RS-232 or Ethernet. The CDI-46 card also acts as an Ethernet-to-serial bridge, so that serially-controlled equipment such as switching matrixes, projectors, other displays, etc., can be controlled from third-party equipment.

As with all Cloud commercial audio products, a remote Music Mute facility is provided (selectable N/C or N/O), which may be used to satisfy the requirements of the Local Fire Officer.

46-120 and 46-120MEDIA – key features

- Eight input (6 line + 2 mic) mixer amplifier for four zones
- Provides versatile music, paging and announcement facilities in each zone
- Built-in digital music player supports MP3 and WMA files from USB memory sticks or SD cards at all standard data rates/sample frequencies (Model 46-120MEDIA only)
- Front panel user controls for music source, music level and level of each microphone, for each zone
- Six (unbalanced) stereo line inputs with individual gain trim controls
- Selectable LINE 6 priority in Zone 1, with choice of release times
- Two balanced mic inputs; 15 V phantom power selectable on either or both
- MIC 1 input can be configured as telephone system interface
- Contact closure access port for paging zone selection – most OEM paging systems supported
- Selectable VOX-triggered mic-over-music priority
- Sensitivity and HF/LF EQ adjustment for mic inputs (rear panel)
- Front panel preset controls for HF/LF EQ for each zone output
- 4 x 120 W power output (4 ohms)
- Optional CXL-46T 70/100V transformer can be fitted internally to any or all zone outputs
- 'T' versions available with CXL-46T transformers factory-installed in all channels
- Dynamic clip limiting in power amplifier stage
- Zones 1 & 2 auxiliary line level outputs (pre-power amplifier), for connection of additional external amplifiers
- Transformer-isolated auxiliary output with independent mic and music level control - for use with telephone MOH systems
- Aux output source selection (internal jumper) – fixed source or mix of Mic 1 and Zone 1 music source
- Zone 1 Facility Port (RJ45) for connection of optional LM-2 Series mic/line remote input/control modules via screened Cat 5
- Selectable 65 Hz high-pass filter per-output (for use with 70/100 V-line systems)
- Music Mute control input (N/O or N/C) for interface to emergency system
- Compatible with standard Cloud remote control plates: RL Series (music level) and RSL Series (music level and source selection), per-zone
- Optional CDI-46 digital interface card with Cloud Digital Paging System port for direct interface to PM Series paging microphones, RS-232 serial port and RJ45 Ethernet port
- Optional EQ cards available to suit various popular installation loudspeakers may be fitted in any or all outputs
- Energy-saving auto power-down function, Ethernet-controllable (when CDI-46 is fitted)
- Remote standby mode control by contact closure
- Variable-speed fan cooling
- 2U 19" rack-mounting unit

Block Diagram

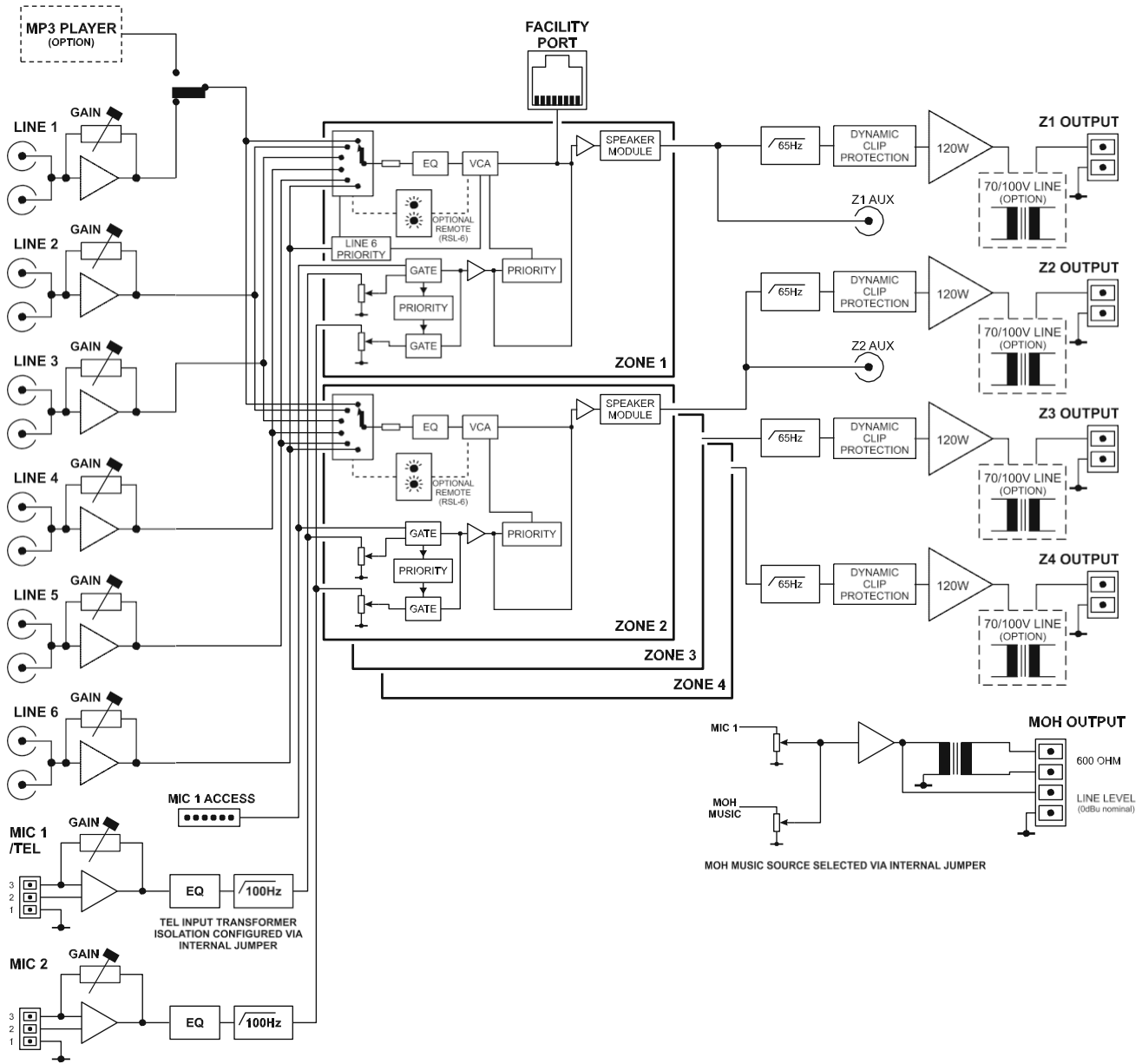

System Example

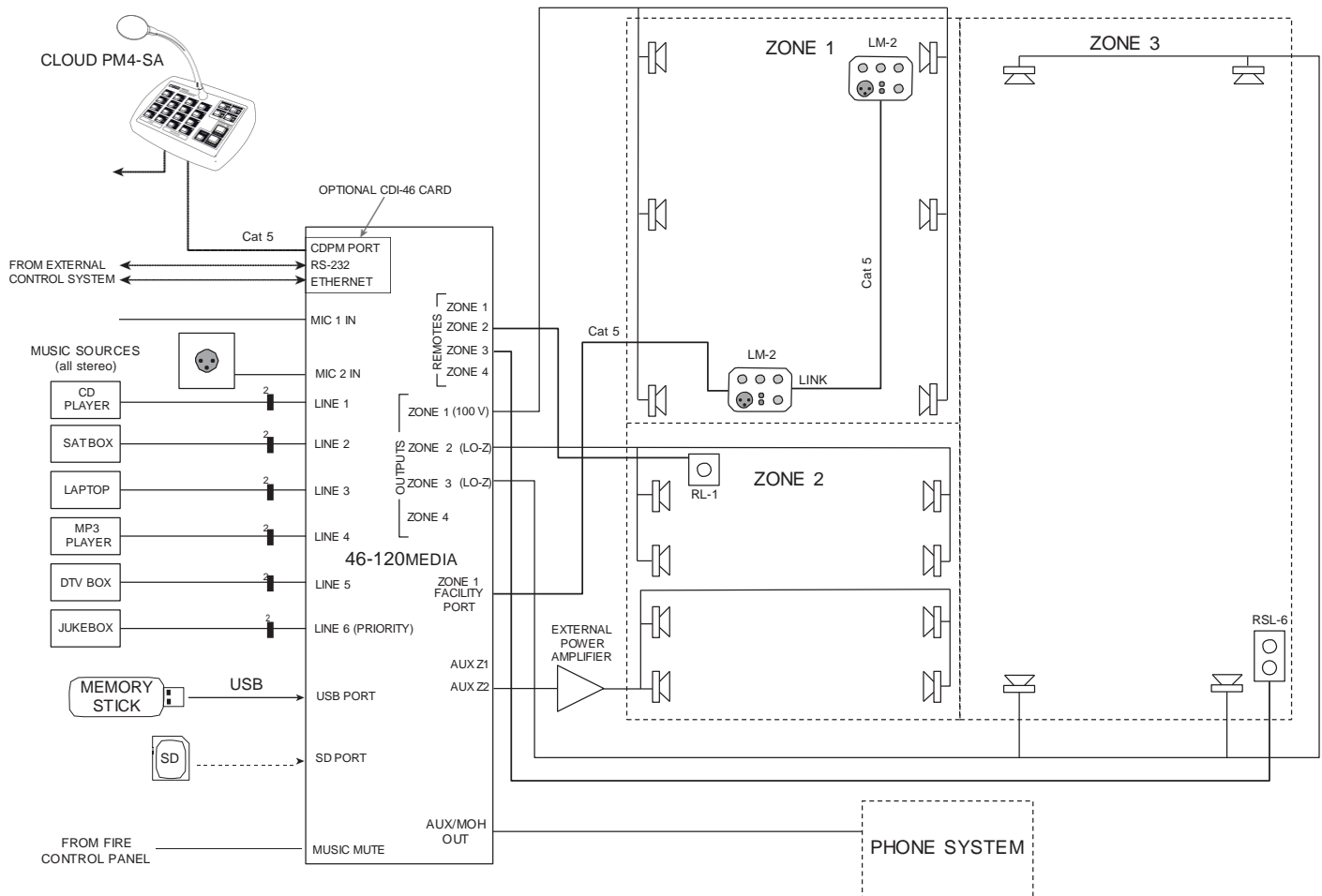

The example shows how the 46-120MEDIA's various features may be used in an installation situation based on three distinct building areas.

- Six stereo music sources are connected to the line inputs. Note that the jukebox is connected to Line 6; if this input priority option is enabled, any jukebox selection will automatically be replayed through Zone 1, overriding the local selection for the duration of the track(s).
- The 46-120MEDIA's internal media player can play audio files from either a USB memory stick or an SD card plugged into the front panel, and the unit's controls used to access and play the files.
- 100 V-line loudspeakers have been installed in Zone 1, so an optional CXL-46T transformer would need to be fitted internally to Zone 1's output.
- Zone 2 might need additional amplification, so as well as some of the loudspeakers being driven directly by Zone 2's output (using series/parallel wiring to ensure that the total load impedance remains above 4 ohms), Zone 2's Aux output is used to drive a separate external power amplifier, which in turn drives further loudspeakers.
- A Cloud PM4-SA paging microphone is connected (via Cat 5) to the CDPM port on the optional CDI-46 Digital Interface Card. This would allow both paging and pre-recorded messages from the internal sound store to be routed to any zone.

- Mic 2 input is wired to an XLR socket (suitable decorative plates are available as standard Cloud accessories) to allow the connection of an additional microphone which can be routed to any or all zones.
- An LM-2 Series remote input/control module is shown in Zone 1; this would be wired back to the 46-120MEDIA's Zone 1 Facility Port using Cat 5. It would allow a microphone and/or a local sound source (e.g., portable music system, DJ mixer, radio mic receiver, etc.) to be plugged in within the zone itself, and routed to the loudspeakers in the zone. The level of the mic and line inputs are adjustable on the LM-2 module itself. The LM-2 also provides remote control of background music source and level in the zone. In a multi-purpose area, it may be convenient to have a second connection point; the LM-2 has a LINK port to facilitate this.
- The system also shows a Cloud RSL-6 Series remote control plate installed in Zone 3 to allow background music source selection and volume control, and an RL-1 in Zone 2 to allow volume control.
- Further remote control options would be available through the Ethernet and/or RS232 ports on the optional CDI-46 card.
- The auxiliary output used to provide Music On Hold (MOH) to the building's telephone system.

Technical Specifications

Line inputs			
Frequency response		20 Hz to 20 kHz +0/-0.5 dB	
THD + N		0.04% @ 1 kHz; 22 kHz bandwidth	
Sensitivity		195 mV (-12 dBu) to 2.0V (+8 dBu)	
Input Gain control		20 dB range	
Input impedance		47 kohms	
Headroom		17 dB	
Noise		-90 dB rms; 22 kHz bandwidth	
Equalisation		HF: ±10 dB @10 kHz; LF: ±10dB @ 50 Hz	
Microphone inputs			
Frequency response		100 Hz -3 dB (fixed filter) to 20 kHz ±1 dB	
Distortion		<0.03% @ 1 kHz, 80 kHz bandwidth	
Gain range		10 dB to 50 dB	
Common Mode Rejection		70 dB typical	
Input Impedance		3.3 kohms (balanced)	
Headroom		17 dB	
Noise		-127 dB EIN 22 Hz - 22 kHz (R _s = 150 ohms)	
Equalisation		HF: ±10 dB @ 5 kHz LF: ±10 dB @100 Hz	
Outputs			
Low Impedance Outputs	4 ohm load	120 W (170 W one channel driven) @ 1 kHz & 0.1% THD+N	
	8 ohm load	85 W (100 W one channel driven) @ 1 kHz & 0.1% THD+N	
	Frequency response	-1 dB @ 20 kHz, -0.5 dB @ 20 kHz	
	Distortion	<0.04% @ 1 kHz, 80 kHz bandwidth	
70/100 V-line output*	Min. load	70V balanced – 42 ohm min. load	
		100 V balanced – 83 ohm min. load	
	Frequency response	-3 dB @ 65 Hz (filter), -2.5 dB @ 20 kHz	
Distortion	<0.06% @ 1 kHz, 80 kHz bandwidth		
Amplifier Protection		Dynamic Clip Protection, VI Limiting, DC Offset, thermal & switch-on delay	
Cooling		Variable speed DC fan (stationary in Idle Mode)	
General			
Power input		230 V ±5% (115 V ±5% by internal connection)	
Fuse rating		230 V:T4A; 100/115 V:T8A	
Fuse type		20 mm x 5 mm HBC	
Power consumption (For thermal dissipation subtract power in the load)	External remote power-down	4.7 W	7.75 VA
	Idle – 4 chs APD	13.4 W	16.75 VA
	Idle – 3 chs APD	16.3 W	20.5 VA
	Idle – 2 chs APD	19.2 W	24.9 VA
	Idle – 1 ch APD	22.2 W	29.4 VA
	Idle, all chs active	25.2 W	33.6 VA
	Noise input, 1/3 rated power, 4 ohms	440 W	560 VA
	Noise input, 1/3 rated power, 8 ohms	275 W	362 VA
Dimensions	Net	482.6 mm x 88 mm (2U) x 407 mm / 19" x 3.5" x 16"	
	Shipping	598 mm x 157 mm x 542 mm / 24" x 6" x 21"	
Weights	Net	46-120/46-120MEDIA: 11.75 kg (26.32 lbs) 46-120T/46-120TMEDIA: 15.75 kg (35.28 lbs)	
	Shipping	46-120/46-120MEDIA: 13.95 kg (31.25 lbs) 46-120T/46-120TMEDIA: 17.95 kg (40.21 lbs)	

* with optional CXL-46T transformer(s)

Performance Graphs

46-120 Front Panel Music Attenuation

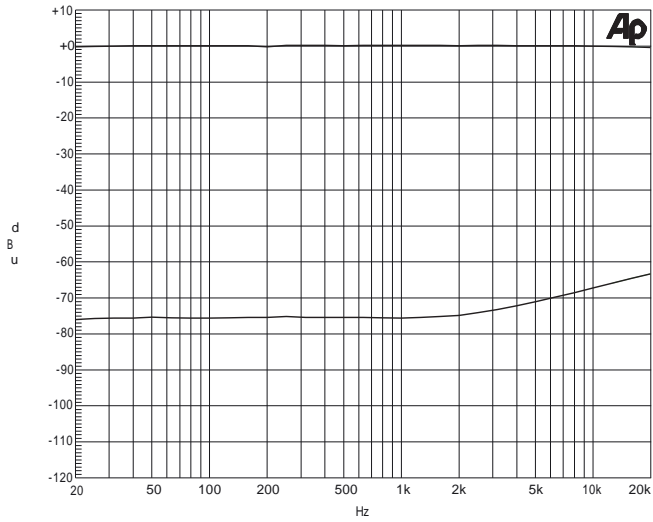

46-120 Mic Frequency & Tone Control Response

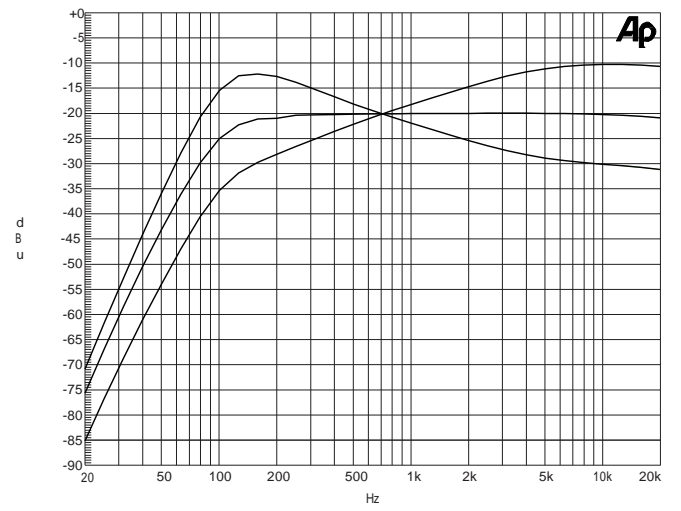

46-120 Line Input Frequency Response

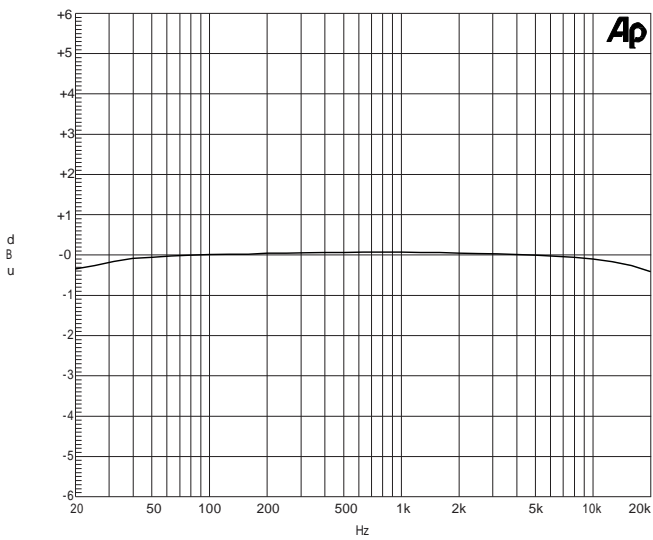

46-120 Zone 1 Line Input Crosstalk

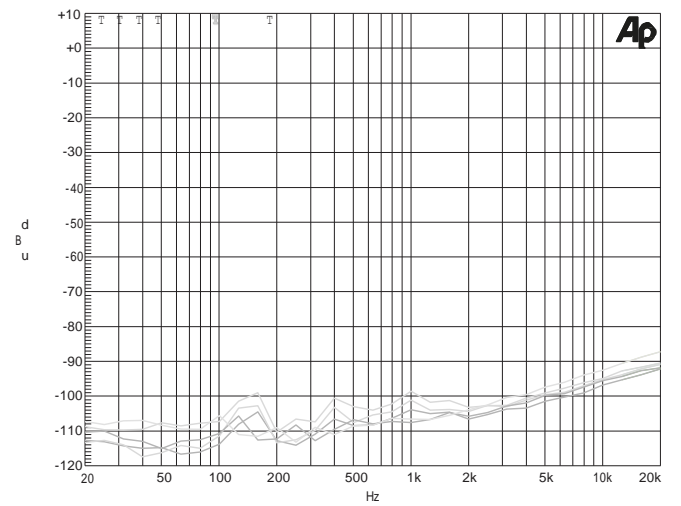

46-120 Line Input Tone Controls

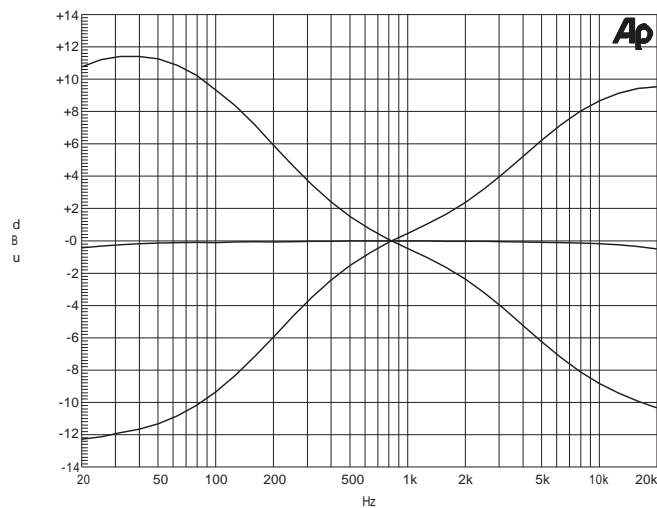

Architect's and Engineer's Specification

The mixer amplifier shall be available in two versions: with and without a built-in digital media player. Unless specifically stated otherwise, the following specification is applicable to both versions.

The mixer amplifier shall have four mono output channels; each channel shall be capable of driving 120 watts into a load of four ohms. It shall be possible to fit a transformer within the unit's enclosure to allow it to drive 100 V or 70 V line speaker systems; versions of the mixer amplifier shall be available with transformers pre-fitted to all channels. The transformers shall also be retrofittable. Two of the zones shall be equipped with unbalanced line level outputs suitable for driving external amplifiers; use of these outputs shall not interrupt the unit's normal operation. There shall be an additional auxiliary output; this shall be galvanically-isolated to make it suitable for connecting to the MOH (Music-On-Hold) input of an analogue telephone system.

The mixer amplifier shall be equipped with six unbalanced stereo music inputs on rear panel phono sockets (RCA jacks) and two electronically balanced microphone inputs on multi-pin screw-terminal connectors. One microphone input shall be configured to operate with paging microphones and it shall also be possible to configure this input for connection to an analogue telephone system, to permit paging to be performed from a telephone extension. In this configuration, the microphone input shall be galvanically-isolated. Each music input shall have an input gain trim control with a range of 20 dB and each microphone input shall have an input gain trim control with a range of 40 dB; two-band equalization adjustment shall be provided for each microphone input; the equalization controls shall not be user-accessible. Phantom power shall be available at the microphone inputs when selected by internal jumper.

The mixer section shall mix the microphone inputs with the mono sum of the selected music input for each output zone. Each output zone shall have dedicated front panel controls for selection of music source and music level and the levels of each microphone input. The front panel shall also have controls of the preset type for two-band equalization adjustment in each zone. A tamper-proof cover shall be provided to make the equalization controls inaccessible in normal operation. A front panel LED will illuminate if either the music or microphone signal levels reach clip level.

A control input shall be provided to activate one microphone input by external contact closure, and route its signal to any or all outputs. It shall be possible to configure the mixer amplifier such that this microphone signal automatically reduces the music signal by approximately 30 dB while it is present. It shall also be possible to configure the mixing amplifier so that i) one line input will automatically override all others in one zone, even if unselected; it shall be possible to set the time over which the selected source is restored after the override input ceases to one of three values of up to 12 seconds; ii) one microphone input shall have priority of the other should both be active simultaneously.

Optional remote control panels shall be available to permit control of i) music level in any zone; ii) music source selection and music level in any zone; it shall be possible to retrofit these to the mixer amplifier at any time. The remote control panels shall connect via a rear panel multipin connector. It shall be possible to disable either the front panel music level or the music source selection controls by switches not accessible to the user.

One zone of the mixer amplifier shall be provided with a multi-function control port using a connector of the RJ45 type. An optional active input module shall be available which may be wired to this

connector using standard screened Category 5 cable, enabling external mic and/or line level signals to be routed to the zone from a remote location. The connector shall also permit the direct connection of a balanced audio source, and provide DC power for the remote plates. It shall be possible to configure the mixer amplifier so that a signal at this input has priority over the other microphone inputs. It shall be possible to control music source selection and music level via this port.

The mixer amplifier shall accept a range of plug-in equaliser cards to permit use with compatible loudspeakers. It shall be possible to fit these in any or all of the outputs.

An optional digital interface module shall be available. It shall be possible to retro-fit this to the mixer amplifier at any time. The module shall be internal to the unit, and will be equipped with i) an RS-232 serial port on a 3-pin plug-in screw-terminal connector, through which it shall be possible to control primary unit control functions using the appropriate serial codes; ii) an Ethernet port on an RJ45 connector, which shall allow control of all the same functions from a compatible external control device; iii) an interface for the Cloud PM Series of Digital Paging Microphones; a dedicated multi-pin connector shall be provided for this purpose.

An external control input shall be provided to allow muting of the music source by a fire alarm or other external emergency system via isolated, 'volt-free' contacts, and this input shall be configurable to respond to either a short or open external circuit.

The mixer amplifier shall be built in a 2U steel chassis for mounting in a standard 19" rack. The mixer will be fitted with a front-panel power switch. The mixer amplifier will be capable of operating from 230 V, 115 V or 100 V AC mains supply. The mains supply shall be connected via a detachable IEC cable.

An alternative version of the mixer amplifier shall be available, which will include an internal digital media player. It will be possible to configure one of the music inputs as the music player's output, in which case that input's rear panel phono inputs will be disconnected. The input used shall not be that on which it is possible to set override priority. The media player shall be able to play audio files recorded in either MP3 or WMA formats using a variety of data rates from 32 kbps and 384 kbps and sample rates from 8 kHz to 48 kHz. The media player shall play audio files either from USB devices such as memory sticks, or standard SD or SDHC memory cards of up to 32 GB capacity. Front panel sockets shall be provided for connection of either type of memory device. Front panel controls shall be provided to start, stop and pause playback, and select the next or previous audio track or file on the memory device. It shall also be possible to select a random track/file playback mode and automatic repeat mode where all tracks/files on the memory device are played repeatedly. LED indication shall be provided for Play, Pause, Random and Repeat modes.

The mixer amplifier shall be the Cloud 46-120 (without media player) and Cloud 46-120MEDIA (with media player); the versions with factory-fitted 100/70 V transformers shall be the Cloud 46-120T and Cloud 46-120TMEDIA. Optional remote control plates shall be the Cloud RL-1 Series (music level only) and the Cloud RSL-6 Series (music level and source selection); the optional remote input module shall be the Cloud LM-2 Series (line and microphone level inputs plus control of music source selection). The optional digital interface module shall be the Cloud CDI-46. The optional internal 70/100 V transformer shall be the Cloud CXL-46T.

Cloud Electronics Limited

140 Staniforth Road, Sheffield, S9 3HF. England. Telephone:
+44 (0)114 244 7051 Fax: +44 (0)114 242 5462
Web: www.cloud.co.uk E-mail: info@cloud.co.uk

Cloud Electronics USA

1200 Iron Horse Drive, Unit A,
Park City,
Utah 84060. United States of America.
Toll Free: 0855 810 0161
Web: www.cloudusa.pro E-mail: sales@cloudusa.pro